

ACTES DE  
COLLOQUE

*Rennes*  
26-29 mai 1998  
Cemagref France



# Ramiran 98 *posters presentations*

8th International Conference on Management  
Strategies for Organic Waste Use in Agriculture

*8<sup>e</sup> conférence internationale sur les stratégies  
de gestion des déchets organiques en agriculture*

*Edited by José Martinez and Marie-Noëlle Maudet*



**Cemagref**  
EDITIONS



European System of Cooperative  
Research Networks in Agriculture  
(ESCORENA)

**Proceedings of the 8th International Conference  
on the FAO ESCORENA Network  
on Recycling of Agricultural,  
Municipal and Industrial Residues in Agriculture  
(Formerly Animal Waste Management).  
Rennes, France, 26-29 May 1998**

**RAMIRAN 98**

*Actes de la 8ème Conférence du Réseau FAO  
ESCORENA sur le Recyclage des Déchets Agricoles,  
Municipaux et Industriels en Agriculture.  
Rennes, France, 26-29 mai 1998.*

*Edited by:  
José Martinez and Marie-Noëlle Maudet*

Proceedings of the Posters Presentations



The designations employed and the presentation of material in this publication do not imply the expression of any opinion whatsoever on the part of the Food and Agriculture Organization of the United Nations concerning the legal status of any country, territory, city or area or of its authorities, or concerning the delimitation of the frontiers or boundaries.

All rights reserved. No part of this publication may be reproduced, stored in a retrieval system, or transmitted in any form or by any means, electronic, mechanical, photocopying or otherwise, without the prior permission of the copyright owner. Applications for such permission, with a statement of the purpose and extent of the reproduction, should be addressed to :

- the Director, Information Division, Food and Agriculture Organization of the United Nations, Viale delle Terme di Caracalla, 00100 Rome, Italy.
- the Chef du service de l'IST, Cemagref, DSIC BP 44 92163 Antony Cedex, France

© FAO and Cemagref 1999

**RAMIRAN 98.** Actes de la 8<sup>e</sup> conférence internationale sur les Stratégies de gestion des déchets organiques en agriculture. Rennes 26 – 29 mai 1998. **Volume 2 consacré aux présentations dites « posters ».** Coordination de l'édition : José Martinez et Marie-Noëlle Maudet. Impression et façonnage : imprimerie Cemagref, Antony, France. Vente par correspondance : Publi-Trans, BP 22, 91167 Longjumeau Cedex 9 - France, tél. 01 69 10 85 85. Diffusion aux libraires : Tec & Doc Lavoisier, 14, rue de Provigny, 94236 Cachan cedex – France  
© FAO et Cemagref 1999, ISBN 2-85362-531-1. Dépôt légal : 2<sup>e</sup> semestre 1999. Prix : 250 F TTC (38,11 € TTC).

# Ramiran 98

8th International Conference on Management Strategies for Organic Waste Use in Agriculture.

8ème Conférence Internationale sur les Stratégies de Gestion des Déchets Organiques en Agriculture.

*Edited by José Martinez and Marie-Noëlle Maudet*

## **Advisory and Programme Committee :**

J. Martinez - Cemagref France, Local Organizer.  
J.E. Hall - WRC, Network Co-ordinator, UK.  
J.C. Fardeau – INRA, France.  
B.F. Pain - IGER North Wyke, UK.  
G. Guiraud – CEA, France.  
F. Béline – Cemagref, France.  
C.H. Burton - Silsoe Research Institute, UK.  
D. Chadwick - IGER North Wyke, UK.  
A. de Guardia - Cemagref France.

## **Organizing Committee :**

J. Martinez, Conference Organizer.  
M.N. Maudet, Conference Secretary.  
F. Béline.  
P. Peu.  
F. Guiziou.  
D. Rogeau.  
A. de Guardia  
G. Le Bozec.

## **Avec la participation de :**

F. Roche - Cemagref Rennes, Directeur.  
R. Krell – FAO, Rome.  
I. Alvarez – FAO, Rome.  
R. Pochat – Cemagref, Antony.  
J. Clément – Cemagref, DSIC, Antony.  
C. Cédra – Cemagref, DSIC, Antony.  
M. Boudot-Lamotte – Cemagref, Antony  
V. Lucas - Hôtel Mercure, Rennes.  
F. Egido – Cemagref, Rennes.  
K. Morel – Hôtesse d'accueil, Rennes.

## Résumé

Ce volume complète les actes de la 8<sup>ème</sup> Conférence Internationale d'un Réseau FAO sur le Recyclage des Déchets Agricoles, Municipaux et Industriels en Agriculture (réseau RAMIRAN), qui s'est tenue à Rennes du 26 au 29 mai 1998. Il rassemble notamment une sélection de 39 articles présentés sous forme de « poster » ainsi que deux synthèses issues des groupes de travail.

Le thème de la Conférence était les stratégies de gestion des déchets organiques utilisés en agriculture et cette session poster était organisée en 4 parties :

- Stratégies de gestion des déchets organiques utilisés en agriculture.
- Valeur agronomique des déchets organiques.
- Mesure, modélisation et maîtrise des émissions gazeuses.
- Traitement et gestion des déchets.

Dix articles sont présentés dans la première partie sur le thème des stratégies de gestion allant de la variabilité dans l'épandage de fumiers et lisiers aux systèmes de réglementation en vigueur dans la région Lombarde en Italie.

La deuxième partie comprend une série de dix articles sur la valeur agronomique, articulés autour de la caractérisation des déchets à recycler, le risque de contamination bactérienne lié à leur utilisation ainsi que la détermination de la dose optimale pour une meilleure efficacité azotée.

La troisième partie traite de la pollution de l'air provoquée par l'activité agricole et notamment les émissions d'ammoniac, de protoxyde d'azote, de méthane et d'odeurs. Les résultats présentés identifient les principales sources (bâtiment, stockage, épandage) et les principaux produits organiques étudiés : lisiers, fumiers, composts, boues, et témoignent de nombreuses interactions entre ces différents composés gazeux.

La quatrième partie décrit différents procédés de traitement et de gestion des déchets, notamment des lisiers, à travers des techniques telles que l'aération, la construction de zones humides ou le traitement chimique par ajout d'additifs.

Enfin deux articles issus des groupes de travail sur les déchets solides et sur les éléments traces métalliques sont présentés.

## **General Abstract**

This volume extends the Proceedings of the 8<sup>th</sup> International Conference of the FAO ESCORENA Recycling of Agricultural, Municipal and Industrial Residues in Agriculture Network (RAMIRAN), held in Rennes, France from 26 to 29 May 1998. It contains a selection of poster presentations plus two surveys coming from the expert groups.

The theme of the Conference was Management Strategies for Organic Waste Use in Agriculture and this poster session was divided into four parts :

- Management strategies for organic waste use in agriculture.
- Agronomic value of organic wastes.
- Measurement, modelling and control of gaseous emissions.
- Processing and handling of wastes.

There were ten poster papers presented in the first part, covering a wide range of topics, from the variability in the distribution of manure from slurry or solid manure spreaders to the regulatory system for manure management in the Lombard region of Italy.

The organic wastes can be a source of nutrients for plant nutrition. Through the ten papers presented on the theme Agronomic values the wastes have been considered as that source of nutrients but also their contamination potential for soils and waters has been taken into account.

The third part offered a comprehensive overview on the ongoing research work in the field of gaseous emissions from handling and utilisation of organic residues in agriculture. The authors mainly focused on ammonia, but also on methane, nitrous oxide and odour emissions. It became clear that a lot of interactions occur between emissions of various gases.

Part four covered the different aspects of processing wastes, with a special attention on livestock slurries through biological processes (aeration, constructed wetland) and chemical approaches.

Finally two survey papers produced from the expert groups on solid manure and on trace elements are published in this volume.

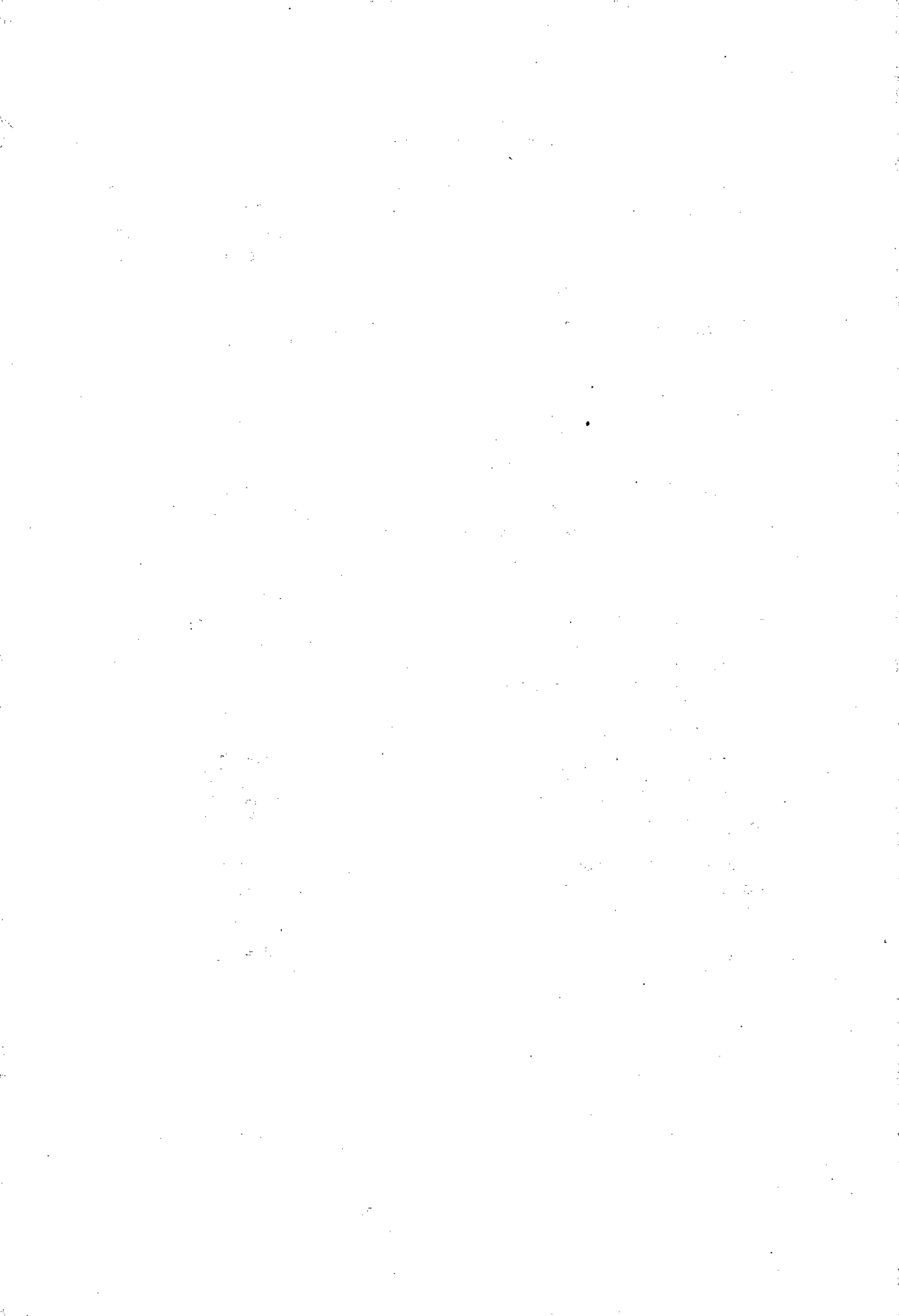



## Table of Contents

<b>Preface</b> .....	11
<b><u>Part 1 bis : Management strategies for organic waste use in agriculture.</u></b> ..	13
Poultry housing and manure management systems : recent developments in Italy as regards ammonia emissions.....	15
<i>F. da Borso, R. Chiumenti (Italy)</i>	
Logistical considerations for spent mushroom compost utilisation. ....	23
<i>W. Magette, S. Smyth and V. Dodd (Ireland).</i>	
Environmental impacts of outdoor pig production.....	31
<i>H. Menzi, W. Stauffer, U. Zihlmann, P. Weisskopf (Switzerland).</i>	
Case studies of waste minimisation on farms.....	41
<i>R.J. Nicholson, D.J. Baldwin, J.P. Metcalfe, K.A. Phillips, P. Brumpton (U.K.).</i>	
A survey of toxic organics in Norwegian sewage sludge, compost and manure.....	51
<i>B. Paulsrud, A. Wien, K.T. Nedland (Norway).</i>	
Animal slurry management and lombard regulations : an example of application.....	61
<i>G. Provolo, F. Sangiorgi (Italy).</i>	
Effect of housing system, litter versus totally slatted floor, on mass balances of water, nitrogen and phosphorus in growing-finishing pigs.....	71
<i>P. Robin, P.A. Oliveira, D. Souloumiac, C. Kermarrec, J.Y. Dourmad (France).</i>	
A farmer-operated system for recycling food waste and municipal sludge to agriculture.. ..	79
<i>O.J. Skjelhaugen (Norway).</i>	
A management perspective on improved precision manure and slurry application.....	89
<i>K.A. Smith and D.J. Baldwin (UK).</i>	
Management of pig slurry for nitrogen fertilization of corn.....	97
<i>Y. Fauvel and T. Morvan (France).</i>	
<b>Chairman's summary of part 1 bis</b> .....	107

**Part 2 bis. Agronomic value of organic wastes..... 109**

Valorisation of organic wastes in agriculture. Compostage supply for the use of organic matters as background nitrogen fertilizer.. ..... 111  
*F. Bouanani, M. Domeizel, A. Prone (France).*

Agronomic value of alkaline stabilised sewage sludge solids.. ..... 121  
*P. Christie, D.L. Easson, J.R. Picton, S.C.P. Love (UK);*

Survival of manure-derived pathogens in soil..... 129  
*D. Cools, G. Van der Velde, R. Merckx, J. Verhaegen, K. Vlassak (Belgium)*

Environmental impact of NPK-fertiliser versus anaerobic digestion residue or compost - A system analysis..... 139  
*M. I. Dalemo, A.E. Björklund, U.G. Sonesson (Sweden).*

Yield effect and utilization of nitrogen from solid manure ..... 149  
*U. Walther and U. Herter (Switzerland).*

The utilization of differently treated sewage sludges in agriculture. .... 159  
*P. Ruzek, J. Hrazdira and H. Kusa (Czech Republic).*

Nitrogen regime of two bulgarian soils after 30 years of mineral and organic-mineral fertilisation (<sup>15</sup>N study)..... 167  
*V. Koutev and E. Ikonomova (Bulgaria).*

Predicting the fertilizer nitrogen value of farm manure applications to agricultural land.. ..... 177  
*F.A. Nicholson, B.J. Chambers, E.I. Lord and K.A. Smith (U.K).*

Bacteriological and chemical (nitrogen, phosphorus) characterization of liquid wastes discharged by four dairy farms. (Vendée, France). .... 185  
*S. Reyne, C. Cheverry, J. Marrec (France).*

Long term effects of excessive organic waste application. .... 195  
*A. Siegenthaler, H. Hänni and W. Stauffer (Switzerland)*

**Chairman's summary of part 2 bis ..... 205**

**Part 3 bis. Measurement, modelling and control of gaseous emissions.. 207**

Emissions of NH<sub>3</sub>, N<sub>2</sub>O and CH<sub>4</sub> from composted and anaerobically stored farmyard manure.. ..... 209  
*B. Amon, Th. Amon, J. Boxberger A., Pollinger (Austria)*

Ammonia emission from naturally ventilated building for dairy cows.....	217
<i>J.B. Dollé (France).</i>	
Comparison of ammonia losses under various conditions after organic fertilization.....	225
<i>S. Générmont, D. Flura, P. Cellier (France).</i>	
Stable isotopes to investigate decay processes in farm wastes.....	235
<i>P.J. Hobbs, R. Johnson and D. Chadwick (UK).</i>	
Emission rates of odorous compounds from pig slurries..	243
<i>P.J. Hobbs, T. H. Misselbrook and B.F. Pain (UK).</i>	
Source separation of human urine - nitrogen and phosphorus emissions.....	251
<i>H. Jönsson, B. Vinneras, A. Burström, C. Höglund, T.A. Stenström (Swedish).</i>	
Estimating ammonia losses during the composting of farmyard manure, using closed dynamic chambers..	261
<i>T. Morvan, J. Dach, P. Cellier (France).</i>	
Nitrogen deposition on forests and open land in regions with different livestock densities.....	267
<i>G. Steffens, K. Mohr, F. Lorenz (Germany).</i>	
Odour and ammonia emission control by slurry treatment and covering.....	275
<i>G. Hornig, W. Berg., U. Wanka (Germany).</i>	
Human urine and effluents from digestion of food refuse as a fertiliser to barley- Crop yields, ammonia emission and nitrate leakage. ....	285
<i>H. Elmsquist, L. Rodhe, M. Blomberg, S. Steineck, B. Lindén</i>	
<b>Chairman's summary of part 3 bis</b> .....	295
<b><u>Part 4 bis. Processing and handling of wastes</u></b> .....	297
Aeration of cattle slurry at low or high temperature in finish climate.....	299
<i>H.Heinonen-Tanski. (Finland)</i>	
Treatment of animal wastewater in constructed wetlands.....	305
<i>P.G. Hunt, A.A. Szogi, F.J. Humenik and J.M. Rice (USA)</i>	
The new AB composting process : application to the pilot unit of stan at Castelnaudary (France).....	315
<i>O. Leclerc, J.L. Martel, I. Vandeuvre (France).</i>	

Liquid pig manure treatment in a farm plant : fate of polluting elements before and during storage in a shallow lagoon. ....	325
<i>L. Senez, J.C. Coquille, Y. Couton, C. Devroe, J.C. Germon, J.P. Lemière (France).</i>	
Mineralflow : A model to determine cost efficient strategies to improve pig slurry application under de Dutch MINeral Accouting System. ....	335
<i>C.P.A. van Wagenberg, G.B.C. Backus (The Netherlands).</i>	
Effects of an enzymatic additive on ammonia concentration on a broiler farm. ....	345
<i>G. Bonazzi, C. Fabbri, , L. Valli (Italy).</i>	
Comparison of the survival of <i>Salmonella Typhimurium</i> in the solid fraction from agricultural wastewater treatment plant in summer and winter seasons..	355
<i>J. Venglovsky, I. Placha, N. Sasakova, Para L. (Slovak Republic).</i>	
Adsorption properties of zeolite (clinoptilolite) and bentonite applied to pig slurry.. ....	363
<i>J. Venglovsky, N. Sasakova, Z. Paajova, I. Placha (Slovak Republic).</i>	
Hygienic requirements in aerobic and anaerobic treatment of biological wastes. ....	371
<i>R. Böhm (Germany).</i>	
<b>Chairman's summary of part 4 bis</b> .....	<b>379</b>
<b>Working Group Reports</b> .....	<b>381</b>
Solid manure in Europe. Results of a survey by the working group on solid manure of RAMIRAN .....	383
<i>H. Menzi, B. Pain, K. Smith</i>	
Report of an enquiry of network members into the status of metals in animal manures. ....	401
<i>R.J. Unwin</i>	

## Preface

The eighth international conference of the FAO Recycling of Agricultural Municipal and Industrial Residues in Agriculture Network (formerly the Animal Waste Management Network), was held in Rennes, France from 26 to 29 May 1998. The conference gathered nearly 150 delegates representing more than 26 countries. Colleagues from all European countries, Japan, Canada, USA, Russia and Chile were present in Rennes.

The FAO European Cooperative Network on Animal Waste Management was formed in 1976. The principal activity of the network is for members to exchange research information and to prioritise work topics, which are then undertaken by expert groups. The need to change the direction and name of the network to RAMIRAN, was agreed at the last network meeting in Godollo, Hungary in 1996. After 20 years of focusing on animal wastes, it was necessary now to include municipal and industrial wastes as these were increasingly spread on land and were also the cause of environmental pollution. Animal wastes remains a significant component of the network's activities but would be considered in a more integrated manner with other wastes which had similar benefit and problems when spread on land.

The theme of the conference was **Management Strategies for Organic Waste Use in Agriculture** and the conference was into five sessions :

- Management strategies for organic waste use in agriculture
- Agronomic value of organic wastes
- Measurement, modelling and control of gaseous emissions
- Processing and handling of wastes
- Environmental impacts

During these session, 43 papers were presented, including four invited papers (C.H. Burton, J C Fardeau, J-M. Merillot and B.F. Pain). This papers were published in a previous proceedings issue. In addition, 50 poster papers were displayed and each was allowed a short oral presentation. A selection of 39 poster papers are published in this book, together with two expert group reports (H. Menzi, R. Unwin).

The Conference confirmed the importance of the ad hoc Expert Groups as the focus of network activities between meetings. Progress on their activities will be reported at a workshop planned for 2000 to be held at the Institute of Agricultural Engineering, Milan, Italy. It is planned to hold the 9th major meeting in 2002, which provisionally will be hosted by the Research Institute of Experimental Veterinary Medicine at Kosice, Slovakia.



**Part 1 bis**

**Management strategies for organic  
waste use in agriculture.**

**Chairman : M. GOSS (Canada)**

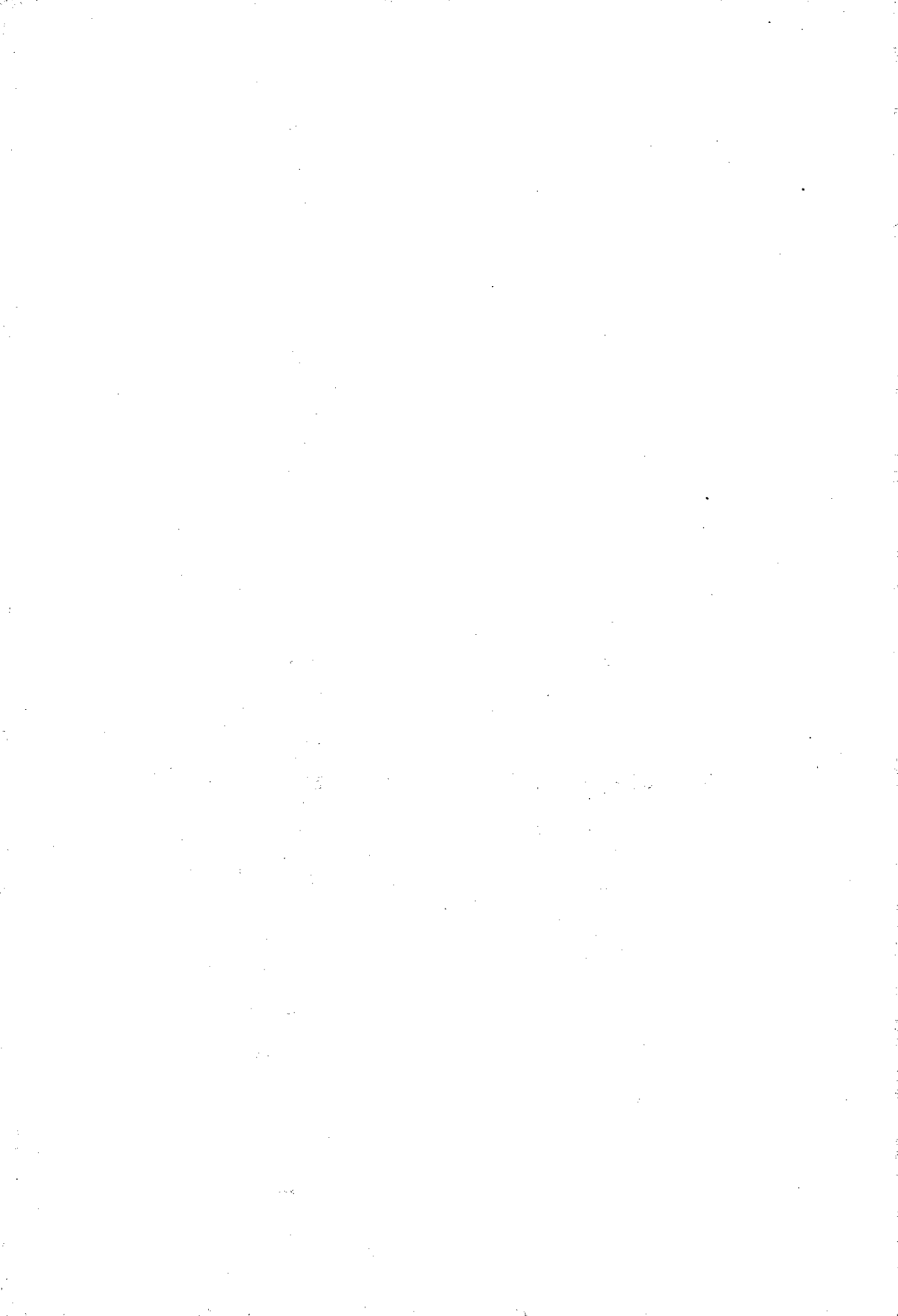



# **Poultry Housing and Manure Management Systems : Recent Developments in Italy as Regards Ammonia Emissions**

*Bâtiments avicoles et systèmes de gestion des déjections : développements récents en Italie, en lien avec les émissions d'ammoniac.*

**F. da Borso, R. Chiumenti**

University of Udine, Department of Crop Sciences and Agricultural Technologies,  
Section of Agricultural Engineering, Via delle Scienze, 208 - 33100 Udine, Italy  
E-mail : Francesco.daborso@dputa.uniud.it

## **Abstract**

*Laying hen and broiler keeping systems strongly developed during the last years, aiming to the reduction of environmental impacts (especially of emissions in atmosphere) and to make easier poultry manure management. As concerns broiler structures, no advances technologies are applied, but simple management systems can significantly reduce ammonia and odour emissions ; to give an example, the adoption of an adequate height of litter layer and the use drop-collecting drinking nipples allowed a reduction of ammonia level to 6 ppm, in respect to about 20 ppm of the « traditional » system tested. As concerns the laying hen compartment, several studies on the vertical batteries with manure drying on belts were carried out, showing a sufficiently improved management of poultry manure. Therefore, the possibility of reaching higher levels in dry matter of manure must be closely examined.*

Keywords : poultry manure, ammonia and odour emission, drying, composting.

## **Résumé**

De nombreux systèmes ont été développés récemment dans le but de réduire l'impact environnement (notamment les émissions atmosphériques) et de faciliter la gestion des déjections avicoles (fumiers de volailles et pondeuses). En ce qui concerne les bâtiments volailles de chair, de simples mesures permettent de réduire les émissions d'ammoniac telles que l'épaisseur de la litière et l'amélioration des systèmes d'abreuvement.

En ce qui concerne les bâtiments de pondeuses, plusieurs études sur le séchage ont montré leur efficacité. Cependant ces systèmes ne permettent pas d'obtenir un taux de matière sèche du produit au delà de 50% ; ce séchage incomplet s'accompagnant de nuisances olfactives et d'émissions d'ammoniac au cours du stockage et de l'épandage.

Mots-clés : fumier volailles, ammoniac et odeurs, séchage, compostage.

## **1. Introduction**

Modern poultry breeding techniques have been developed with the purpose of improving farm productivity, automation and environmental impacts, both indoors (i.e. animal health and welfare, workers' safety) and outdoors (i.e. preservation of soil, water and air quality and their related ecosystems). Several studies which dealt with housing and manure management systems have been carried out by our Department in order to have an insight into these aspects.

The aim of the present work is to review different housing and manure handling systems which are adopted in broiler and laying hen sectors, as far as ammonia emission are concerned.

## **2. Materials and methods**

During a period of 3 years and taking several technical, environmental, energy and economic parameters into account, the following full scale poultry barns were monitored at a full scale :

- I. broiler litter bed floor houses,
- II. laying hen houses with different types of batteries and manure drying systems,
- III. alternative-to-cage systems for laying hens (litter bed and perches),
- IV. laying hen houses with manure drying and storage in deep pit.

When the housing systems were characterized by natural ventilation (systems I and III) ammonia concentration were measured with a photo-acoustic infrared instrument, the Bruel & Kjaer 1320 with 1303 Multiplexer; air samples were taken in several points inside the barn in order to calculate the mean indoor ammonia concentration. Ammonia emissions were calculated basing on airflow rate estimate by means of the carbon dioxide balance method; the carbon dioxide produced by animals was estimated at 41 ml CO<sub>2</sub> per kJ of the total heat produced by one bird (Albright, 1990).

Under artificial ventilation conditions (systems II and IV), ammonia concentrations were measured with the above mentioned instrument; however, air samples were taken in the airflow at the fan outlets. Ammonia emissions were calculated basing on airflow rate measurements by means of hot-wire and magnetic transducer anemometers.

Further details on sampling points and frequencies will be given in the specific paragraphs.

### 3. Broiler houses

Most of the broiler produced in Italy are bred on litter bed in floor barns. Several experimental tests were carried out by our Department with the purpose of improving litter management in these housing systems, i.e. litter material, height of the layer, number of birds per m<sup>2</sup>, drinking and eating equipments, litter discharge and storage methods, etc.; aim of the present review is to quantify the effects of different drinkers on ammonia emissions. With regard to this aspect, tests were carried out in 2 barns which were identical in reference to the number of animals (12,800 birds each), the size (12 m x 99 m each) and the litter material (wood sawdust). Hence, it was possible to compare ammonia levels in the air from barn equipped with nipple drinkers with those from the barn equipped with nipple drinkers plus bowls, used for preventing water dropping.

Indoor air was hourly sampled during a period of 9 days in summer; ammonia concentrations were significantly lower in the barn with nipple drinkers + bowls, apparently because of a lower moistening of litter below drinkers. The mean airflow rate was estimate to be 2.4 m<sup>3</sup> h<sup>-1</sup> bird<sup>-1</sup> ; this estimate showed ammonia emissions of 0.657 and 0.404 g day<sup>-1</sup> bird<sup>-1</sup>, for the nipple and nipple + bowl drinkers respectively (Table 1).

<i>Drinker type</i>	<i>Birds / drinker, number</i>	<i>Estimated ventilation rate, m<sup>3</sup> h<sup>-1</sup> bird<sup>-1</sup></i>	<i>Ammonia concentration, mg m<sup>-3</sup></i>	<i>Ammonia emission, g day<sup>-1</sup> bird<sup>-1</sup></i>
Nipples	6.5	2.4	11.4	0.657
Nipples + bowls	12.4	2.4	7.01	0.404

*Table 1*  
*Results of ammonia determination in broiler barns*

### 4. Laying hen batteries with manure drying

In Italy, a large number of laying hens are kept in new types of batteries which allow a partial drying of manure on the conveyer belts. Since 1991, the following manure drying systems were studied by our Department :

- air moved by a system of paddles over the belts (Salmet Ô);
- air blown by fans through holed air-ducts over the belts (i.e. Valli Ô);
- air sucked by fans into tunnels over the batteries where manure belts flow (Farmer Ô).

During a period of 1 year, several parameters (i.e. manure characteristics, energy consumption, environmental aspects, etc.) were monitored in full scale barns characterized by different manure drying systems. With regard to ammonia emissions, results are shown in Table 2.

<i>Manure drying system</i>	<i>Ammonia emission in winter, g day<sup>-1</sup> bird<sup>-1</sup></i>	<i>Ammonia emission in summer, g day<sup>-1</sup> bird<sup>-1</sup></i>
Paddle system	0.031	0.172
Air blown in holed ducts	0.027	0.157
Air sucked in tunnels	0.027	0.134

*Table 2*  
*Results of ammonia determinations in laying hen barns characterized by different manure drying systems*

Ammonia emissions from barns equipped with fan drying system batteries were lower than those from barns characterized by paddle drying system batteries, both in winter and in summer. However, it must be noticed that ammonia emissions from all the 3 manure drying systems were considerably lower than those usually shown by batteries without any drying system. In fact, previous studies concerning barns which adopted stair-step cage batteries with gutters and scrapers for manure removal showed that ammonia emissions were about 0.18 g day<sup>-1</sup> bird<sup>-1</sup> in winter and up to 0.70 g day<sup>-1</sup> bird<sup>-1</sup> in summer.

## **5. Alternative-to-cage systems for laying hens**

Housing systems where laying hens are not confined in cages are present in several European Countries. Until today, these systems have assumed a relatively little importance in Italy, but the interest in them is growing especially in relation to the animal welfare requirements as well as to the egg marketing advantages.

Because of this increasing importance, an experimental research was carried out focusing on the environmental requirements which these alternative systems have to meet.

During 3 weeks in spring, two alternative poultry barns were monitored; they were identical in relation to the ventilation system (natural ventilation), the relative surface of the bed floor and the perches to the total surface (the litter bed floor was 1/3 of the total surface), the animal density (7 birds m<sup>-2</sup>), but they differed from each other in the age of breeding animals; one barn kept pullets, the other laying hens.

The mean indoor ammonia concentration was higher in laying hen barn than that one in pullet barn; the estimated ammonia emission was 0.262 and 0.192 g day<sup>-1</sup> bird<sup>-1</sup>, for laying hens and pullets respectively (Table 3).

Type of birds	Ammonia Concentration, $\text{mg m}^{-3}$	Estimated ventilation rate, $\text{m}^3 \text{h}^{-1} \text{bird}^{-1}$	Estimated ammonia emission, $\text{g day}^{-1} \text{bird}^{-1}$
Pullets	5.4	1.48	0.192
Laying hens	7.0	1.56	0.262

*Table 3*  
*Results of ammonia determination in alternative-to-cage housing systems for laying hens*

## 6. Laying hen housing systems with deep pit storage

The housing system with deep pit storage is characterized by a subdivision of the barn into two levels: laying hens are kept in stair-step cages at the raised-floor, while poultry manure is stored at the ground floor during the whole hen production cycle (over 12 months). A mechanical ventilation system allows both the air changing at raised-floor and a partial drying of poultry manure at the ground floor. The inlets of fresh air are located under the eaves, while the suction fans are placed at the ground floor on the side walls. Hence, the air coming from the upper level can pass through the mesh floor and and/or through the batteries and it can flow on the manure piles at the ground floor.

An outstanding research which is presently being conducted by our Department deals both with ammonia emissions from this kind of housing system and manure characteristics during and after the storage period. Tests are being carried out in two barns which are characterized by identical size but different types of floor on the service passages between the batteries; in one poultry barn there is a wire-mesh floor and hence the air can pass both the mesh floor and the cages, while in the other there is a solid floor which allows the air to pass only through the cages.

Preliminary results have shown that the ammonia emissions from laying hen housing systems with deep pit storage are higher than those from the other housing systems ( $0.870 - 0.626 \text{ g day}^{-1} \text{bird}^{-1}$ , for wire-mesh floor and solid floor respectively, Table 4).

Floor type in the corridors	Ammonia emission $\text{g day}^{-1} \text{bird}^{-1}$
Wire mesh floor	0.870
Solid floor	0.626

*Table 4*  
*Results of ammonia determinations in laying hen houses with deep pit storage*

## 7. Discussion and Conclusions

Several experimental studies have been carried out by our Department with the purpose of quantifying the effects of different housing and manure management systems on air quality, and in particular on ammonia emissions.

Ammonia emissions from poultry barns were important especially in summer. If we consider that the initial nitrogen concentration in laying hen manure is 45 g total N kg<sup>-1</sup> dry matter, the calculated nitrogen losses as ammonia emissions ranged from about 6.1 to 39.6% of the total initial manure nitrogen.

Regarding the final nitrogen content in broiler litter as 35 g total N kg<sup>-1</sup> dry matter, the ammonia emissions caused losses which ranged from 22,8 to 32,7% of total final litter nitrogen.

Drinking equipments for broilers influenced litter bed moisture and consequently ammonia production from the barns. Ammonia emission from broiler barns where drinkers for water loss prevention (i.e. nipples + collecting bowls) were adopted, presented a 38.5% reduction, in comparison with those from broiler barns characterized by simple nipple drinkers.

Ammonia emissions were reduced down to 80% by timely poultry manure drying inside the barns, in comparison with ammonia emissions from stair step batteries without any manure drying systems and a twice-a-month manure removal by scrapers.

Ammonia emissions from the “alternative-to-cage” systems were higher than those from the above mentioned cage systems, but in the same time they were lower than those from the litter bed housing systems for broilers.

Ammonia emission from the housing systems where poultry manure is stored in deep pit were the highest, ranging from 0.62 to 0.87 g day<sup>-1</sup> bird<sup>-1</sup>, certainly due to the long term indoor storage (13 months); moreover, sensible seasonal effects on ammonia emission could be expected.

Lastly, it must be considered that the storage of poultry manure inside the barns played an important role on emissions, as regards some of the systems above described. For this reason, further studies should be necessary in order to determine the “global” ammonia emissions from the different housing and manure management systems. For example, considering the poultry manure produced in broiler and laying hen cage barns, it should be necessary to quantify the ammonia losses which can occur during manure storage outside the barns.

## 8. References

**Albright, L.D.** Environment control for animals and plants (DeVore-Hansen, P. ed), Michigan: ASAE, 1990, pp 166-169.

**Chiumenti, R.; da Borso, F.; Pinosa, M.** Layer keeping systems with manure drying on belts: environmental effects. Proceedings 19<sup>th</sup> WPSA Congress 20-24 September, Amsterdam, The Netherlands 1992, (3): 282-288.

Climatization of Animal Houses, Report of working group of C.I.G.R. Commission Internationale di Génie Rural, 1984, pp 1-27.

**Da Borso, F.; Chiumenti, R.; Lenarduzzi, M.** Sistemi alternativi alle gabbie per l'allevamento delle galline ovaiole (Alternative-to-cage housing systems for laying hens). Proceedings of 6<sup>th</sup> National Congress of Agricultural Engineering of AIIA 10-12 September, Ancona, Italy, 1997, (2): 453-462.

**Feddes, J.J.R.; Leonard, J.J.; McQuitty, J.B.** Carbon dioxide concentration as measure of air exchange in animal housing. Canadian Agricultural Engineering 1984, 26: 53-56.

**Groot Koerkamp, P.W.G.** Review on emission of ammonia from housing systems for laying hens in relation to sources, processes, building design and manure handling. Journal of Agricultural Engineering Research 1994, 59: 73-87.





# Logistical Considerations for Spent Mushroom Compost Utilisation

*Considérations logistiques pour l'utilisation du compost de champignonnières.*

**W. Magette, S. Smyth and V. Dodd**

Agricultural and Food Engineering Department, University College Dublin

Earlsfort Terrace, Dublin 2, Ireland.

E-mail : william.magette@ucd.ie

## Abstract

*Intensive agricultural enterprises such as mushroom producers generate volumes of organic wastes that generally exceed the capacity of land resources under their direct control to safely assimilate. In the case of Ireland's mushroom industry, the fact that producers are concentrated into distinct geographic locations amplifies the problem of safely utilising a by-product of production: spent mushroom compost. This paper presents a preliminary evaluation of the logistical constraints and possible alternatives for both agricultural and non-agricultural uses of spent mushroom compost. Considered are problems of transport, production techniques, regulatory controls, citizen opposition, economics, and inertia against change within the mushroom industry.*

Keywords : waste management, sustainable development, spent mushroom compost.

## Résumé

Les entreprises agricoles intensives, comme les producteurs de champignons, engendrent des volumes d'ordures organiques qui dépassent, généralement, la capacité des ressources du terrain, sur leur contrôle direct, d'assimiler les ordures sans risques.

Dans le cas de l'industrie des champignons en Irlande, le fait que les producteurs soient concentrés dans des emplacements géographiques distincts amplifie le problème d'utilisation prudente des dérivés de production. Cet article présente une évaluation préliminaire des contraintes logistiques et les autres possibilités pour l'usage agricole et non agricole du compost vide des champignons. Nous avons considéré les problèmes de transport, les techniques du production, la législation, l'opposition des citoyens, l'économie et l'inertie contre le changement dans l'industrie des champignons.

Mots-clés : gestion déchets, développement durable, compost champignonnières.

# 1. Introduction

One of the great success stories within Irish agriculture is the mushroom industry that has developed over the last 20 - 30 years. The industry now produces product valued at approximately IR£60 million. Most of this production is exported to the U.K. and other European countries, where Irish mushrooms are renowned for their uniform, high quality and long shelf life. Irish mushrooms are grown at competitive prices due to a unique production system based upon 1) a pre-packaged compost growth medium, 2) relatively simple and inexpensive production facilities (*i.e.* polyethylene tunnels), and 3) a meticulous level of quality control.

An inevitable by-product of mushroom production is compost that can no longer sustain an economically viable yield of mushrooms. This so-called "spent" mushroom compost (SMC) is rich in organic matter; fairly high in the macro-nutrients nitrogen (N), phosphorus (P), potassium (K) and calcium (Ca); and has a high electrical conductivity (Table 1). Like most other organic sources of nutrients, SMC would be considered an unbalanced fertiliser because the macro nutrients are not in the correct proportions to each other for normal plant nutrition.

Large quantities of SMC are produced by the industry. A typical production cycle in the Irish mushroom industry is 10 - 12 weeks in duration. When production facilities are emptied of the spent compost at the end of this cycle, a single, typically-sized facility generates approximately 18 t of SMC, resulting in an annual load of 260,000 t per annum for the entire industry. Applying the average values for

	Total analysis		Available nutrients <sup>1</sup>	
	% of DM	Fresh material	(mg L <sup>-1</sup> )	
Bulk Density (kg/m <sup>3</sup> )		329	pH	6.6
Dry Matter (%)		31.5	EC (µS/cm)	7,500
Organic Matter	65.0		Nitrate-N	63
N	2.55	8.0 kg/t	Ammonium-N	50
P	1.24	3.9 kg/t	P	32
K	2.50	7.9 kg/t	K	2,130
Ca	7.25	22.8 kg/t		
Mg	0.67	2.1 kg/t		

<sup>1</sup> Availability analysis was carried out on a water extract from a 1:1.5 volumetric (SMC:water) mixture and the results expressed as mg L<sup>-1</sup> of extract.

**Table 1**  
*Mean composition of spent mushroom compost in Ireland*  
*(from Maher and Magette, 1997).*

N and P content of SMC as given in Table 1, the industry “generates” 2,080 t of N and 1,014 t of P per annum that must be managed.

## 2. Key Obstacles to SMC Management

### Physical characteristics of the Irish mushroom industry

Like other organic waste by-products that derive from agricultural production, management of SMC by returning it to the land is, ostensibly, the most logical alternative. However, like virtually every other type of intensive agricultural enterprise (e.g., pig and poultry rearing), mushroom production can take place independently of whatever land base is necessary to produce the inputs it uses. Economically, this permits small entrepreneurs with limited capital and land resources to become successful mushroom producers. Unfortunately, it also facilitates concentrations of producers, often in regions that are unsuitable for other types of agriculture. This combination of factors has caused severe environmental problems in Ireland in the recent past with the pig industry (Dodd and Champ, 1983). While being concentrated in distinct regions, individual producers are relatively dispersed within the regions.

The primary input for mushroom production is fresh compost, which is a special-purpose blend of straw (from wheat or barley) and a nutrient source (typically poultry manure) that has undergone controlled biological degradation.

### Lack of Waste Management Oversight

Heretofore, mushroom producers have not had to be directly involved in the *ultimate* management of SMC. Instead, many producers have simply hired specialist contractors to remove the compost at the end of a production cycle.

In short, the ultimate management of SMC has been unsupervised; contractors have been left to their own devices for disposing of the material by whatever mechanism yields them the biggest profit. In some cases, farmers have used SMC judiciously for its nutrient value. However, such responsible uses have been overshadowed by the widespread occurrence of the unsustainable disposal practices. Except for large producers that are required to obtain an Integrated Pollution Control (IPC) license from the Environmental Protection Agency, it is not clear that Irish waste management laws apply directly to SMC.

### Packaging

Pre-packaged compost is one factor in the success of the Irish mushroom industry. At the manufacturing plant, fresh compost made to specification is mechanically filled into plastic bags, which are loaded onto flatbed (or enclosed) articulated lorries for distribution to mushroom producers. At destination, the bags of compost are off-loaded and placed in the mushroom tunnels, at which time they are shaped

into cylinders and trimmed to remove excess plastic from around the tops of the bags. Casing material is placed on the surface of the compost and the production cycle begins. Thus, the bags which originally facilitated compost transport continue service as containers for mushroom production. To this extent, the plastic bags are convenient and utilitarian.

However, at the end of the production cycle, the plastic bags add to the SMC management problem. On the one hand, the bags themselves represent a waste by-product that requires management. In cases where bags are separated from the SMC, "management" includes incineration and landfilling, neither of which is in keeping with a "recycling" ethos. In other cases, no attempt is made to separate the bags from the SMC they contain, and the bags are co-disposed with the SMC in landfills, sink holes, bogs, fields, and along roadsides. Recycling at a proper plastic recycling facility is not viable at present due to the fact that even after they are emptied, the bags still contain a significant amount of SMC adhering to the bag surface. Even if producers were inclined toward recycling, the fact that they are relatively dispersed would preclude the practice until "regional" recycling facilities become available, until an economically viable collection system is established, or both.

### Hygiene

Most mushroom producers are extremely careful about maintaining a high standard of hygiene in and around the production facilities.

Concerns about hygiene also constrain how SMC might be transported from its point of origin to its ultimate point of use. For example, a logical mechanism for returning SMC to where raw materials for the fresh compost originated would be to use the same lorries that transported the fresh compost. However, this practice would introduce the possibility that the compost production facility could become contaminated with organisms pathogenic to mushrooms. This would have a disastrous impact on a large number of producers.

### Competition for Spreadlands

The application to land of organic by-products from any intensive agricultural enterprise must follow a mass balance principle (Dodd, 1991). In general, nutrients (or more specifically N and P) are the controlling elements of concern when land applying organic wastes.

However, the same constraint pertains to other intensive enterprises desiring to use land as a waste management option. In addition, government programmes to encourage environmentally friendly farming practices (DAFF, 1996) will further restrict the availability of land for use by intensive producers. Restrictions on soil test phosphorus levels remove additional land from the available pool. In combination, these constraints have a significant influence on the location of new intensive agricultural enterprises (Magette, Carton and Power; 1997) and on the distances that existing producers may have to travel to find suitable agricultural spreadlands. In reality, agricultural land may not always be readily available as a management option for every mushroom producer.

### User Demands

As just outlined, when the ultimate management site for SMC is agricultural land, the needs of users (*i.e.* farmers) are fairly easy to estimate. In general, farmers want an inexpensive, yet reliable source of nutrients in a form that is easy to handle and apply uniformly. If, however, the ultimate destination of SMC were not agricultural land, other users could have quite different demands.

The landscaping industry is seen to be one potential user of SMC. Leonard (1998) surveyed landscape contractors in the northwest region of Ireland to determine their attitudes about and demands for SMC as a product in their businesses. Respondents indicated they would prefer a product delivered to them (in bales) at a cost not exceeding IR£10 m<sup>-3</sup>. Home gardeners have been suggested as a possible end user of SMC that has been further composted (Leonard, 1998; Teagasc, 1993), but no market survey to identify demand (in terms of SMC volume and characteristics) has yet been performed.

Incineration also has been suggested as a potential SMC management alternative (Teagasc, 1993). However, on its own, SMC has a rather low calorific value (Smyth, Magette and Dodd, 1998) and is not, therefore, a suitable fuel source. SMC might well be appropriate for co-incineration with other wastes. While incineration would facilitate pathogen destruction and dramatically reduce the volume of material to be handled, it would do nothing to alter the mass of P that must be managed. Incineration as a technique for SMC management alone is probably not economically viable; nor is there much public support for incineration of any type.

## **3. Preliminary Analysis and Potential Management Solutions**

Our preliminary assessment of the SMC management problem, together with our experience in addressing similar organic waste management problems, has led us to the following “conclusions”. These are shaping our thinking toward developing a long-term problem solution.

1. SMC management must be organised and coordinated; *i.e.*, individual growers should participate in a group solution rather than trying to solve only their own SMC management concerns.
2. SMC management must be based primarily on land application, although other management alternatives (*e.g.*, commercial markets, incineration) may have a role in a total solution.

### Group Solution

The chaotic and environmentally unfriendly manner in which much SMC management is currently taking place is illustrative of the failure of individual attempts at SMC “management”. Likewise, the current variety of unsound (*i.e.*, unsustainable) *disposal* practices (as opposed to *management* practices) is

reflective of 1) economic pressures that force cheap solutions and 2) lack of specific regulatory controls over most SMC uses.

A group (or coordinated) solution would spread the costs of SMC management over many “users” and could also keep costs down through the realisation of economies of scale. In addition, a group solution would facilitate a higher level of quality management in all aspects of the management operation, though the employment of trained personnel with dedicated job responsibilities. Lastly, a coordinated solution would facilitate sustained growth of the mushroom industry.

Given that a group SMC management approach should be adopted, several organisational models could be suggested. At one end of the spectrum, the scheme could be totally privatised, being operated by a commercial entity that may have no connection whatsoever with the mushroom industry. Alternatively, a co-operative approach – quite familiar in agri-business – could be formed, in which individual mushroom producers are members and decide the operational rules for the scheme. The option we favour involves a marriage of these two models in which the producers of fresh compost and marketers of mushrooms are integral participants in the management of the spent compost.

### Land Based Application

The nutrients and organic matter in SMC give it value as a soil amendment for crop production. As for other waste by-products from the agricultural industry, land application is a natural, low cost, sustainable management option for SMC.

Unfortunately, SMC suffers from the same drawbacks as most organic wastes: variability in quality, unbalanced nutrient content, handling problems, and continuous supply but only occasional need. In the Irish mushroom industry SMC also suffers from being encased in a plastic wrapper that has no inherent end-value and represents a management problem by itself. Further, SMC poses a hazard to hygiene in and around active production facilities and must be handled very carefully.

These facts all suggest the need for a management scheme based on centralised « processing » of SMC, if land application is to be a successful ultimate management option. Such a facility would facilitate :

- the removal of plastics using specialised machinery;
- further composting to reduce volume, enhance stability and improve handling characteristics;
- the killing of mushroom pathogens;
- possible blending of additional nutrients to end product to improve nutrient balance;
- bulk storage to span time frames unsuitable for land application;
- possible co-composting of other wastes (e. g. MSW).

Even if this is the model were adopted logistical problems would remain. Siting of such a facility must take into account both location of producers and location of

spreadlands. To protect hygiene around production tunnels, SMC should not be stored or disposed within 2 km of tunnels. Yet, a centrally located SMC processing facility facilitates cost-effective transport. In principle, the collection of SMC from dispersed sources is identical to the collection of solid wastes from domestic households. The techniques for successfully accomplishing this task are widely available.

Determining whether, in fact, re-composted SMC can be transported back to tillage areas is less straightforward. This is difficult to ascertain as most tillage crops in Ireland are grown on contract with specific fertiliser inputs; in order to use SMC the nutrient levels would have to be consistent, or a specially blended commercial fertiliser would need to be developed to correct the nutrient deficiencies inherent with SMC.

### Other Considerations

It is difficult to envision a solution to Ireland's SMC management problem that does not also address the plastics issue associated with SMC. At least one marketing group is exploring the feasibility of using biodegradable plastic bags instead of the currently used polyethylene bags. Our group is examining the possibility of using natural fibre bags. Either of these alternative bags, if economically and technically viable, would solve the plastics recycling dilemma that faces mushroom growers using the "bag and tunnel" system commonplace in Ireland today.

## **4. Conclusions**

**4.1.** While we are confident that a solution to the SMC management issue in Ireland must be coordinated among many mushroom growers, must involve fresh compost producers/mushroom marketers, and must utilise land as the ultimate receptor for the SMC, we have yet to complete our analysis of the logistical problems that preclude such a solution. We have no reservations that these obstacles can be addressed successfully.

**4.2.** A key question will be, however, at what cost a solution can be obtained. Clearly, with narrow profit margins and a relative inability to pass costs on to consumers, producers will be sceptical of any solution, no matter how technically sound, if it significantly increases production costs.

**4.3.** On the other hand, it can no longer be argued that the current *laissez faire* approach to SMC management is sustainable. We hope that a regulatory approach to solving this issue can be avoided. To do so, however, will require a significant attitudinal change among growers and marketing groups. It also may require both internal changes (e.g., alterations in production technique) and external changes within the industry. Lastly, there may need to be coordination at the highest levels of Irish government to assure that land is a viable treatment medium for both extensive and intensive producers of organic and nutrient rich waste by-products.

## 5. Acknowledgements

This work was part funded by EU Structural Funds via the Irish Department of Agriculture and Food Research Stimulus Fund. The authors also appreciate the thoughtful input of Mr. Michael Maher, Teagasc, who is the project leader for the overall research project

## 6. References

**DAFF. 1996.** Rural Environment Protection Scheme Agri-Environment Specifications. 15 May 1996 Revision., Department of Agriculture, Food and Forestry Dublin, Ireland. 74 pp.

**Dodd, V. A.** 1991. Planning for intensive livestock production units. IN: J. Feehan (ed.) Environment and Development in Ireland. The Environment Institute, University College Dublin, Clonskeagh, Dublin, Ireland. pp. 358-367.

**Dodd, V. A. and W. S. T. Champ.** 1983. Environmental problems associated with intensive animal production units, with reference to the catchment area of Lough Sheelin. IN: J. Blackwell and F. J. Convery (eds.). Promise and Performance - Irish Environmental Policies Analysed. Resource and Environmental Policy Centre, University College Dublin, Ireland. pg. 111-129.

**Leonard, P.** 1998. The Use of Spent Mushroom Compost in Landscaping. Teagasc, Dublin, Ireland. 8 pp.

**Magette, W. L., O. T. Carton and V. Power.** 1997. Implications of the Irish EPA's new licensing requirement. IN: T. Matsunaka (ed.) Environmentally Friendly Management of Farm Animal Waste. Rakuno Gakuen, University, Ebetsu, Japan. pg. 23-26.

**Maher, M. J. and W. L. Magette.** 1997. Solving the spent mushroom compost problem. IN: L. Staunton and J. Grant (eds.) Advances in Mushroom Production, Proceedings, 12<sup>th</sup> Teagasc National Mushroom Conference and Trade Show. Teagasc, Kinsealy Research Centre, Dublin, Ireland. pg. 73-82.

**Smyth, S., W. L. Magette and V. A. Dodd.** 1998. A national strategy for SMC management. Agricultural and Food Engineering Research 1997-98. Agricultural and Food Engineering Department, University College Dublin, Earlsfort Terrace, Dublin, Ireland (in press).

**Teagasc.** 1993. Monaghan Agricultural Waste Management Study. Teagasc, Johnstown Castle Research Centre, Wexford, Ireland. 201 pp.



# Environmental impacts of outdoor pig production

*Impact environnemental de la production porcine plein-air.*

**Harald Menzi\*, Werner Stauffer,**  
Institute of Environmental Protection and  
Agriculture Liebefeld (FAL-IUL), CH-3003  
Berne, Switzerland

**Urs Zihlmann, Peter Weisskopf**  
Swiss Federal Research Station for  
Agroecology and Agriculture (FAL), CH-  
8046 Zürich, Switzerland

\* Present adress : Dr. Harald Menzi. Schweizerische Hochschule für Landwirtschaft (SHL). Länggasse 85. CH – 3052 Zollikofen.  
E-mail : Harald.Menzi@shl.bfh.ch

## Abstract

*For animal welfare reasons, outdoor pig production is fast getting popular in Switzerland. We studied nutrient and heavy metal input, effects on soil structure and potential nitrate leaching in such systems with sows and fattening pigs on seven farms. The phosphorous (P) input was 50-340 kg/ha for fattening pigs and 12-150 kg/ha for sows. The heavy metal input surpassed the uptake of a meadow by 100-500 % for copper (Cu) and by 300-800 % for zinc (Zn). Potential nitrate leaching during eight months can be estimated at about 100 kg/ha N for the two mineral soils studied and at 200-250 kg/ha N for the organic soil. Soil compaction was considerable, mainly in feeding and shelter areas.*

Keywords: outdoor pig production, nutrients, heavy metals, nitrate leaching, soil compaction, environmental impact

## Résumé

Les considérations de bien-être des animaux ont induit un intérêt accru pour la production porcine plein air. Nous avons étudié les bilans minéraux et les apports de métaux lourds, ainsi que les effets sur la structure du sol et sur le potentiel d'azote nitrique lessivable de tels systèmes avec truies et porcs à l'engrais au siège de 7 exploitations. L'apport en phosphore s'établit à 50-340 kg/ha pour les porcs à l'engrais et 12-150 kg/ha pour les truies. Les apports de métaux lourds excèdent les exportations par les plantes de l'ordre de 100-500% pour le cuivre et de 300-800% pour le zinc. Le potentiel de lixiviation des nitrates varie entre 100 et 250 kg N/ha selon la nature du sol.

Mots-clés : production porcine plein air, bilan des minéraux, métaux lourds, lixiviation des nitrates, compaction du sol, impact environnemental.

## 1. Introduction

In the past three years outdoor keeping of sows and fatteners has fast gained importance in Switzerland as an animal friendly pig production system in label programs. Various examples on pioneer farms demonstrated that under Swiss conditions the system might pose ecological problems. This is all the more important as consumers expect animal friendly systems to be ecological too. As part of an interdisciplinary program to work out recommendations for outdoor pig production under Swiss conditions (Ingold and Kunz, 1997) the most important ecological impacts expected were therefore studied on a number of practical farms. Work primarily concentrated on soil compaction, nutrient and heavy metal input and nitrate leaching. The aim was to show under what conditions the ecological risk would be too high and to define recommendations for ecologically acceptable outdoor pig production. Furthermore, outdoor pig production was used as a first example to gain experience in searching for feasible compromises in conflicting aims between animal welfare and ecology.

## 2. What we studied

The main part of the study (except nitrate) was done on six farms in different parts of north-eastern Switzerland. All farms were situated between 350 and 520 m above sea level. One was on a sandy alluvial soil, the others on heavier soils with a clay content between 15 and 35 percent. Precipitation was around 80-120 cm per year for all farms. Five of the farms kept 3-10 sows of which all piglets were fattened on the farm up to about 100 kg live weight. The sixth farm had about 50 sows and sold most piglets at 20-30 kg.

The effect of the pigs on soil structure was treated in a qualitative way by regular observations on various plots on all six farms over a period of about two years. No quantitative measurements were made due to the great variability within plots. Observations were mostly done by judging the soil structure using 1 m deep soil cores and "spade samples" of the topsoil. Long-term effects will be studied over some more years on the same farms.

Nutrient (nitrogen - N, phosphate -  $P_2O_5$ , potash -  $K_2O$ ) input was determined by balance calculations on four farms using feed quantities and production results collected by the farmers and analyzed feed contents. In total, the balance for 18 series of fatteners (usually about 30 animals per series) and 34 plots used by lactating or dry sows were calculated. On a total of 47 soil samples conductivity was measured to get an idea about salinity.

The heavy metal load was estimated using the mean content of copper (Cu), zinc (Zn), lead (Pb) and cadmium (Cd) per unit P of pig slurries in Switzerland (Menzi and Kessler, 1998).

To get a first estimate, the nitrate leaching potential of the pig plots the content of mineral nitrogen ( $N_{min}$ ) in 0-90 cm soil depth was measured every two weeks on

three different grassland plots with pigs from May till December 1996. Plot a) was on a loamy soil with a clay content of 17 % and had a mean animal density of about 130 fatteners per hectare for the eight months of the study. It thus received approximately 1300 kg ha<sup>-1</sup> N with excrements. Plot b) was on a sandy soil and had a mean animal density of about 100 fatteners per hectare from May till September, thus receiving about 500 kg ha<sup>-1</sup> N by excrements. Plot c) was on a humic soil with a mean animal density of 16 dry sows per hectare from May till October, thus receiving about 140 kg ha<sup>-1</sup> N by excrements. Four samples were taken from the main "grazing" part of each plot. These results were compared to a control sample taken just outside the pig plot in an area that had previously been farmed together with the pig plot. In addition, on plot a) and b) one sample from the surroundings of the shelter and from the feeding area was analyzed. Every sample was mixed from six sub-samples. For an estimate of nitrate leaching, the nitrate content of the soil was multiplied by the difference between precipitation and evapotranspiration for every two week period of the study (Menzi and Stauffer, 1997).

### 3. Results

#### 3.1. Soil structure

If pigs are permanently kept outdoors over the whole year, their effect on soil structure can be considerable :

- As could be expected, the physical impact on the soil was greatest in the wallowing places and in the vicinity of shelters and feeding installations, because the soil there is often wet and can be kneaded by the pigs up to a depth of more than 25 cm. In addition, soil compaction tends to be highest around the exit of the shelter because of the frequent passing of the animals.
- The compaction of the topsoil was sometimes considerable, especially on soils with a high clay and silt content. Apart from the more intensive compaction on such soils, a greater area is usually affected than on sandy soils. Nevertheless, compaction in the major part of the plots was usually limited to the top 10-15 cm, so that the sub-soil was not affected.
- The risk of soil compaction increased in wet weather conditions. A high risk was also observed in shady places which dry off slowly and in areas where the soil is strongly influenced by groundwater or perched water.
- The burrowing activity of the animals was considerable, especially along the borders of the plot. Nevertheless, it's effect was rather negligible compared to that of trampling. Animals with rationed feeding showed a higher burrowing activity than those fed ad libitum. There was a tendency that burrowing was less on stonier soils. A direct impact on the sub-soil was also observed in some cases in spots where the topsoil was removed by burrowing.

- The plant cover also had a clear influence on the physical impact of pigs on the soil. Where the pigs were kept on older grassland at reasonable animal density, a good proportion of the sward was sustained. This clearly had a positive effect on the soil structure. Nevertheless, during wet and rainy periods of longer duration plant cover and soil structure could sometimes deteriorate drastically within a few days.
- Permeable soils with a high sand and stone content were less affected by the pigs than heavier soils with higher clay and silt content.
- Increased erosion was hardly observed in this study because pigs were mostly kept on more or less flat land. The water holding capacity of the soil decreases with increasing soil compaction. Consequently, a higher risk of impeded infiltration followed by surface runoff and erosion can be expected where pigs are kept on sloped land.
- The two winters in our observation (1995/96, 1996/97) were rather dry and frosty. The frost in most cases was able to restore an acceptable soil structure to about 10 cm depth. Below that depth, kneaded soil areas were usually maintained. A general statement of how long it will take compacted and kneaded soils to recover is not yet possible because of the great importance of uncontrollable weather conditions.

### 3.2. Nutrient input per hectare

Mean nutrient excretions per fatterer and rotation were 4.9 kg N, 2.1 kg P<sub>2</sub>O<sub>5</sub> and 1.7 kg K<sub>2</sub>O, which corresponds well with official Swiss guide values (5.0 kg N, 2.3 kg P<sub>2</sub>O<sub>5</sub>, 2.0 kg K<sub>2</sub>O; Walther et al., 1994). For sows (including piglets until weaning) mean excretions per animal per day were 88 g N, 47 g P<sub>2</sub>O<sub>5</sub> and 44 g K<sub>2</sub>O, which is 15-20 % higher than the guide value. This difference can be explained by the feed content. As expected, lactating sows had higher excretions than dry sows. For the two farms which furnished independent data for lactating and dry sows, this difference was 8-13 %.

The nutrient input per hectare varied within a wide range, depending on animal density and the duration of the animals being on the same surface (fig. 1). The average for fatteners was more than double that of sows for all nutrients (table 1). All farms kept their fatteners on the same surface for the production of one batch of animals. The mean animal density was 119 animals per hectare (84 m<sup>2</sup> per animal). The density decreased in the course of the observations due to our recommendations and growing awareness of farmers to ecological problems. For sows, animal density and the duration of utilization of the same surface varied widely. The utilization intensity is therefore best given in "sow days" per hectare (e.g. 20 sows per hectare for 4 months = 2400 "sow days" ha<sup>-1</sup>). For the lactating sows the average intensity was 2300 sow days ha<sup>-1</sup>, for dry sows 3080 sow days ha<sup>-1</sup>.

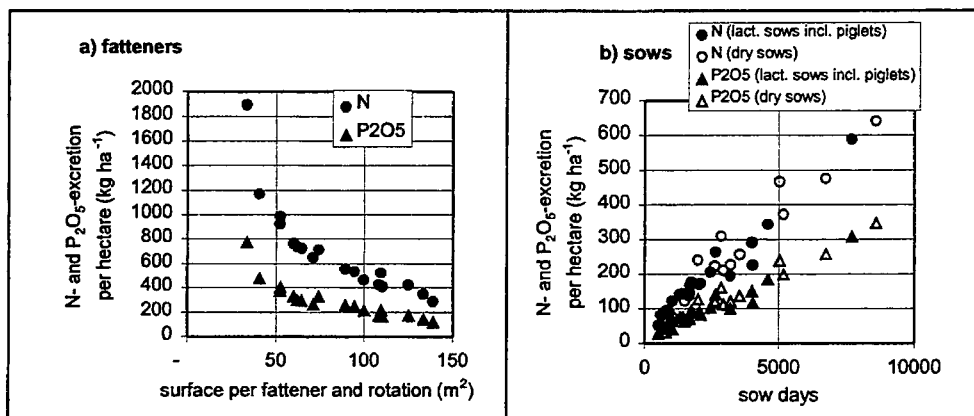

Figure 1

Animal density and nitrogen (N) and phosphate ( $P_2O_5$ ) excretion per hectare for the 18 batches of fatteners and 34 plots with sows on the four farms studied.

			fatteners	sows
m <sup>2</sup> per animal		average	84.5	398
		range	33.5-139	118-1300
utilization per plot (days)		average	123	78
		range	99-147	13-161
sow days <sup>1)</sup> per ha		average	—	2627
		range	—	423-8596
excretion	kg N ha <sup>-1</sup>	average	695	223
		range	290-1890	52-640
	kg P <sub>2</sub> O <sub>5</sub> ha <sup>-1</sup>	average	292	118
		range	120-770	28-350
	kg K <sub>2</sub> O ha <sup>-1</sup>	average	234	110
		range	96-590	22-320

<sup>1)</sup> sows per hectare times number of days on the surface.

Table 1

Surface per animal, duration of utilization per plot and nutrient excretions per hectare on the four farms studied. Average values and ranges for a total of 18 batches of fatteners and 34 surfaces with sows.

To assess the nutrient balance of the surface, the nutrient load in animal excrements can be compared directly to the nutrient demand of crops for  $P_2O_5$  and  $K_2O$ , as no significant loss is expected. For N, Swiss nutrient balance guidelines assume 40-50 % of the N excreted by pigs to be plant available. For fatteners, the mean nutrient load brought to the surface by excrements clearly surpassed the yearly nutrient demand, which according to Swiss guide values (Walther et al., 1994) is 100-150 kg ha<sup>-1</sup> N, 50-100 kg ha<sup>-1</sup>  $P_2O_5$  and 100-300 kg ha<sup>-1</sup>  $K_2O$ . For sows the average load was approximately equal to the demand of intensive crops. The maximum loads observed with fatteners as well as sows by far surpassed crop demand. What surplus can be expected as ecologically reasonable or as compensatable in the long term, is a question which can hardly be answered on purely scientific terms. It must be assumed, that the ecological risk will in any case increase with higher surplus. A

consensus was reached between different experts, that a surplus of 50-100 % could be acceptable, if it is compensated in the following crops.

As excrements are usually not evenly distributed over the whole surface, the local nutrient load can differ considerably from the average. Observations showed that feces were distributed much more evenly than urine. A high urine load was observed especially near the shelter exit of fatteners during winter months. High measurements of salinity and N in these areas as well as poor development of following crops confirmed that this local urine load can reach problematic levels. As the area concerned does usually not surpass few  $\text{m}^2$ , the problem is of very local significance.

### **3.3. Salinity**

Conductivity measurements in soil samples taken after the removal of the pigs in most cases showed an increase in salinity compared to control samples taken outside the pig surface. For the "pasture part" of the surface (excluding shelter and feeding area) the average increase of four plots studied was 39 %. Values did not reach problematic levels. Of 10 samples taken in the shelter area the average increase was 150 % and three samples each were in the categories "possible damage to susceptible crops" (70-150 mg KCl per 100 g soil; Walther et al., 1987) and "possible damage to many crops" (>150 mg KCl per 100 g soil). As mentioned above, this problem can be considered to be of very local importance due to the small surface concerned.

### **3.4. Heavy metal input**

Cu and Zn loads calculated on the basis of mean contents of pig excrements (Menzi and Kessler, 1998) clearly surpassed the yearly uptake of crops (table 2). For fatteners this value for Zn even surpassed the maximum load allowed for sewage sludge (3333  $\text{g ha}^{-1} \text{ year}^{-1}$ ). Should the Cu and Zn content of the feed be above average, the load could be significantly higher than calculated. In any case Cu and Zn input must be considered a problem with ecological importance.

### **3.5. Potential nitrate leaching**

The mean amount of  $\text{N}_{\text{min}}$  in the soil was above 100  $\text{kg ha}^{-1}$  from June to November and clearly higher than in the control samples on all three sites studied. Maximum values were over 250  $\text{kg ha}^{-1}$  on the sandy and the humic soils (sites b) and c)). Nitrate-N concentration of the soil water was 100-200  $\text{mg N l}^{-1}$  on the loamy clay soil (site a)), 100-800  $\text{mg N l}^{-1}$  on the sandy soil and 100-350  $\text{mg N l}^{-1}$  on the humic soil. The estimated nitrate leaching gave results around 100  $\text{kg N ha}^{-1}$  for the loamy clay soil and the humic soil and 200-250  $\text{kg N ha}^{-1}$  on the sandy soil. These amounts could be problematic in the vicinity of drinking water catchment areas. The fact that potential leaching was not higher on site a) in spite of the much higher N input demonstrates that soil type and mineralization induced by burrowing are also important factors determining potential nitrate leaching. Thus, with equal animal density and duration of outdoor pig keeping, leaching can be assumed to be highest on humic soils and higher on sandy soils than on heavier clay soils.

content	Cu	Zn g kg <sup>-1</sup> P <sub>2</sub> O <sub>5</sub>	Cd	Pb
pig slurry	2,1	13,1	0,004	0,04
load	Cu	Zn g ha <sup>-1</sup> year <sup>-1</sup>	Cd	Pb
fatteners	605	3825	1,3	13
sows	245	1546	0,5	5
uptake meadow	65-130	310-470	<1-1,3	25-46

*Table 2*

*Mean heavy metal content per kg P<sub>2</sub>O<sub>5</sub> in pig slurries (g kg<sup>-1</sup> P<sub>2</sub>O<sub>5</sub>; Menzi and Kessler, 1998; Cu - copper, Zn - zinc, Cd - cadmium, Pb - lead) and average metal load of outdoor pigs calculated on the basis of table 1. Comparison with the annual heavy metal uptake of a meadow (yield 10 t DM ha<sup>-1</sup>, heavy metal contents of grass according to Steiger and Baccini, 1990)*

In the shelter areas the N<sub>min</sub> content of the soil was 150-350 kg N ha<sup>-1</sup> on site a) and 600-1700 kg N ha<sup>-1</sup> on site b). Nitrate leaching would therefore be considerably higher in these areas than on the rest of the surface. Again, the importance of these "hot spots" must not be overestimated because they make up only a small part of the total surface. Nevertheless, a better distribution of the excrements and animal activity could help to reduce total nitrate leaching of the outdoor pig surfaces.

## **4. Practical recommendations for ecologically feasible outdoor pig production**

All farmers keeping outdoor pigs should be aware of its potential of negative effects to soil fertility and water quality. In the interest of a sustainable production and good acceptance with consumers they should follow the subsequent recommendations as closely as possible :

### **4.1. Careful choice of suited surfaces**

- Best suited are flat surfaces on light or medium heavy soils. Unsited are heavy and wet soils in regions with high precipitation (Zihlmann and Weisskopf, 1997).
- Catchment areas of drinking water are unsited.
- Sloped surfaces should not be near lakes or creeks because of run-off losses.
- Grassland is better suited than bare arable land because of its higher bearing capacity (less damage to soil structure) and its nutrient uptake.

#### **4.2. Reasonable animal density**

- At least 150-200 m<sup>2</sup> should be available per fattener and rotation. Nutrient excesses, soil structure damage and potential nitrate leaching would be too high with a higher animal density.
- For sows the utilization intensity should not surpass 2500-3500 "sow days" (e.g. 300-500 m<sup>2</sup> per sow for 3-5 months).

#### **4.3. Optimized feeding strategy**

- The protein, phosphorous, copper and zinc content of the ration should not exceed animal needs.

#### **4.4. Well adapted installation and organization of the pig surface**

- Animals should be induced to distribute their activity and excrements more evenly on the whole surface. This can be achieved by a wide distribution of shelters, feeding area and wallowing place as well as by a regular displacement of the shelters.
- The feeding area should be covered by a hard but water permeable surface.
- The number of wallowing places should be as limited as possible (one per plot).

#### **4.5. Agronomic considerations**

- The nutrient input (especially P<sub>2</sub>O<sub>5</sub>) should be accounted for in the subsequent crop.
- Wherever possible, the pigs should be kept on an established grass sward or other surfaces with plant cover, especially in regions and periods with high precipitation.
- After outdoor pigs it is advisable to use the surface for crops with a good tolerance of high local nutrient concentrations (e.g. maize or sown grassland). If necessary, the surface should be leveled out.

### **5. Acknowledgements**

We thank Dr P. Kunz for the coordination of the interdisciplinary project and Ms U. Ingold and the farmers for their data collection.

### **6. References**

Ingold U. and Kunz P. (Eds.), 1997: Freilandhaltung von Schweinen. Schweizerische Ingenieurschule für Landwirtschaft, Zollikofen and Landwirtschaftliche Beratungszentrale Lindau, 153 pages



**Menzi H. and Stauffer W.**, 1997: Stoffflüsse in der Schweinefreilandhaltung. In Ingold U. und Kunz P. (Eds.): Freilandhaltung von Schweinen. Schweizerische Ingenieurschule für Landwirtschaft, Zollikofen und Landwirtschaftliche Beratungszentrale Lindau, 102-111

**Menzi H. and Kessler J.**, 1999: Heavy metal contents of manures in Switzerland. In : Ramiran 98, Proceedings of the 8th International Conference on Management Strategies for Organic Waste Use in Agriculture, Rennes, France, 26-29 May 1998, Martinez J., Maudet M.N. (eds), FAO-Cemagref Editions, 495-506.

**Von Steiger B. and Baccini P.**, 1990. Regionale Stoffbilanzierung von landwirtschaftlichen Böden mit messbarem Ein- und Austrag. *Bericht 38 des NFP "Boden"*, 53 pages

**Walther U., Ryser .P., Flisch R. and Siegenthaler A.F.**, 1987: Düngungsrichtlinien für den Acker- und Futterbau. Swiss agricultural research stations, 36 pages

**Walther U., Menzi H., Ryser .P., Flisch R., Jeangros B., Kessler W., Maillard .A., Siegenthaler A.F. and Vuilloud P.A.**, (1994) Grundlagen für die Düngung im Acker- und Futterbau. *Agrarforschung* 1/7, 1-40

**Zihlmann U. and Weisskopf P.**, 1997: Einfluss der Freilandschweinehaltung auf die Bodenstruktur. In Ingold U. und Kunz P. (Eds.): Freilandhaltung von Schweinen. Schweizerische Ingenieurschule für Landwirtschaft, Zollikofen und Landwirtschaftliche Beratungszentrale Lindau, 112-115



## Case studies of waste minimisation on farms

*Etude de cas de « minimisation » de la production de déchets à la ferme.*

### **Nicholson R.J.**

ADAS Boxworth, Battlegate Road,  
Boxworth, Cambridge, CB3 8NN, UK  
E-mail : nick.nicholson@adas.co.uk

### **Baldwin D.J , Metcalfe J.P.**

ADAS Wolverhampton , Wergs Road ,  
Wolverhampton, WV6 8TQ, UK

### **Phillips.K.A.**

ADAS Crewe, Lyme Building, Westmere  
Drive, Crewe, Cheshire, CW1 1ZD, UK

### **Brumpton P.**

ADAS Gleadthorpe Grange, Meden  
Vale, Mansfield , Notts, NG20 9PF, UK

## **Abstract**

*In 1996 a research project was set up to investigate whether waste minimisation principles could be applied in agriculture. Information was collected on existing practices and disposal routes on ten farms : types included dairy, beef/sheep, intensive pigs and poultry, arable, mixed arable/livestock and field vegetables. Opportunities for waste minimisation were identified together with the farmer. On the 10 farms studied, a total of 50 new opportunities were identified. These arose from savings in wasted animal feeds, reductions in water and energy consumption, savings in purchased fertiliser through better utilisation of animal wastes, reductions in wasted crop produce in the field or store and potential for recycling some packaging.*

Keywords : Waste Minimisation, Energy, water, feed, fertiliser, packaging, plastics, sheep dip, pesticides, manual.

## **Résumé**

Un projet a été développé en 1996 pour évaluer le principe de « minimisation » des déchets à la ferme. Les informations recueillies ont porté sur les pratiques courantes et sur les schémas de résorption sur 10 exploitations : celles-ci comprenaient une exploitation laitière (bovins/ovins), une porcherie et une exploitation avicole (volailles intensives) ; cultures, polyculture/élevage et légumes. Les opportunités pour minimiser les déchets ont été identifiées en compagnie de l'exploitant agricole. Ceux-ci vont d'économies dans l'aliment du bétail gaspillé à la réduction de la consommation d'eau et d'énergie, à des économies dans l'achat de fertilisants chimiques à travers une meilleure utilisation des déjections animales, à des réductions dans le gaspillage des récoltes au champ ou lors du stockage et au potentiel de réduction des emballages.

Mots-clés : minimisation déchets, énergie, eau, aliment, fertilisant, emballage, plastiques, pesticides.

## **1. Introduction**

EU and UK Government overall strategies on waste<sup>(1)</sup> and sustainable development<sup>(2)</sup> include strong encouragement of recycling in order to minimise waste streams going to landfill or incineration.

Two recent projects in U K industry<sup>(3) (4)</sup> aimed specifically at waste minimisation, have proved very successful at identifying specific opportunities for modifying processes so as to reduce, eliminate or recycle waste streams, often at minimum cost. There was therefore interest in whether waste minimisation principles could be applied to agriculture. Study 1, outlined below, indicated that this is in fact the case. Whilst this study received some publicity, it was felt that a self- help manual for farmers might help the techniques to become more widely adopted.

There has been considerable concern over the increasing use of pesticides<sup>(5)</sup>. It has been suggested that use might be reduced by alternative strategies to reduce weeds, pests and diseases<sup>(6) (7)</sup>. Disposal of spent sheep dip has given rise to concerns over water pollution<sup>(8)</sup>. The use of veterinary medicines has been questioned where there is a possibility of residues entering the food chain. Disposal of containers and packaging for both pesticides and veterinary products may pose pollution risks.

## **2. Objectives**

### **2.1. Study 1**

The overall objective was to quantify the economic and environmental benefits that could be obtained by farmers through a policy of waste minimisation.

### **2.2. Study 2**

The overall objectives were :

- (a) To carry out further case studies to identify the opportunities for waste minimisation and reduction in environmental impact from pesticides and veterinary products, including spent sheep dip.
- (b) To produce a user-friendly manual and pilot the draft manual on at least 20 farms of different types.

### **3. Methodology**

#### **3.1. Study 1**

The existing methodology which had been developed for industry involved (a) gaining company commitment, (b) establishing an evaluation team, (c) collecting data on processes, (d) ranking options for waste minimisation, (e) technical and economic feasibility analysis, (f) reporting and implementation of recommendations and (g) review and feedback following implementation<sup>(9)</sup>. This was simplified and adapted for use in this study. Leading farmers / innovators representing the following representative farm types were studied:

- Dairy (all grass) (2 FARMS)
- Beef / Sheep
- Intensive Pigs
- Mixed Arable / intensive pigs
- Arable (cereals/roots) (2 FARMS)
- Intensive Poultry
- Mixed Arable / dairy
- Field Vegetables (including packhouse)

A series of proforma check lists were drawn up to collect data and identify all significant waste generation processes for specific enterprises. Costs of disposal if known, were recorded. Disposal routes for waste were categorised using a series of codes. The audit was carried with the farmer, manager, or member of farm staff appropriate to the tasks being studied.

A comparison was made with existing standards, where these were available. Information on good environmental practice for agriculture is contained in MAFF's Codes of Good Agricultural Practice for the Protection of Water, Air and Soil<sup>(10)</sup><sup>(11)</sup><sup>(12)</sup>. Appropriate data sources were used for other inputs<sup>(13)</sup><sup>(14)</sup><sup>(15)</sup>. If outputs or usage were particularly high or near the standard, then a cause and possible remedy was sought.

Annual statistics on fertiliser use<sup>(16)</sup> confirm that farmers often virtually ignore the potential contribution from organic manures. On the farms with livestock, therefore, an assessment of likely crop nutrient requirements and their supply from current fertiliser use and from farm manures was made, using typical values for manure nutrient content<sup>(13)</sup>. Any potential excess or shortfall in nutrient supply was then identified and new recommendations for fertiliser and manure use were made

#### **3.2. Study 2**

##### **3.2.1. Further Case Studies**

Twelve farms of different types were identified. For the pesticides three were farms with arable crops and three with field vegetables. For the sheep dip / veterinary products, three were farms with lowland sheep and three with upland sheep. A detailed audit was undertaken with the farmer, as in the previous study.

### 3.2.2. Manual

Methodology used in the draft manual was based on procedures established in Study 1<sup>(17)</sup>. Appropriate specialists were used to provide data for 20 individual sections on different operations. The draft manual contained 93 pages. Some topics received up to 6 sides of A4 questions and information and some received only 2 sides. Piloting of the manual was carried out both by farmers, and by ADAS Consultants in conjunction with their farmer clients, who were asked to complete the sections for the wastes appropriate to the farm. Feedback on the technical content and ease of use of the manual was established, using a questionnaire to facilitate analysis.

## 4. Results

### 4.1. Study 1

#### 4.1.1. General

A total of 50 new opportunities were identified. Eight of these related to livestock feed, five to electricity, and eighteen to wastes. The largest potential saving on an individual farm was £9,725 per annum. Table 1 shows opportunities by number, category and value. These figures include "cost-neutral" opportunities identified, where there will be little difference in costs, but an environmental benefit could be obtained e.g. by accumulating and segregating items for recycling. In all but five cases, payback period was less than three years. In 25 cases, costs were zero or minimal, although 12 of these were cost neutral with little financial benefit.

In addition a total of 24 worthwhile existing practices was recorded, with a total estimated gross annual value of £76,500. Seven were in the animal feed category.

Of an annual total of 308 outputs of non-livestock wastes, such as packaging and plastics, a total of 104 were burnt and 48 recycled as scrap.

ITEM	NUMBER	TOTAL ESTIMATED GROSS VALUE £/YEAR	AVERAGE GROSS VALUE, £/YEAR
Feed	8	5,370	671
Packaging	1	700	700
Fertilisers	4	3,388	847
Chemicals	0	-	-
Fuel	1	400	400
Electricity	5	4,543	909
Other inputs	4	948	237
Wastes	18	9,022	501
Produce	9	11,157	1,240
TOTALS	50	35,528	710

*Table 1  
Waste minimisation opportunities by number and annual gross value*

#### **4.1.2. Environmental Benefits**

As a result of improved use of manures there would be a reduced risk of nutrient losses to ground and surface waters. A potential total annual reduction of 19 tonnes of fertiliser purchased could be achieved on four of the farms, thereby avoiding energy and other inputs for manufacture and transport. In addition, 38 less half-tonne capacity polypropylene bags would need disposal. A estimated annual total of 43.5 tonnes of feed wasted could be avoided on four farms, thereby avoiding energy inputs for growing crops and energy for processing and transporting feed. An estimated total of around 200 tonnes of crop loss could be avoided each year thereby avoiding energy and other inputs for growing the crops, but also in several cases, reduction in risks of potential ground water pollution due to effluent release from stockpiled crop waste. On three farms, potential energy savings totalling 76,000 kWh per annum were identified for space heating-benefits resulting in reduced CO<sub>2</sub> emissions from power generation utilising fossil fuels. On farms producing silage, there was a potential for plastic bale wrap or sheet to be recycled, reducing inputs required for plastic manufacture and obviating the current practices of burning or burial and reducing CO<sub>2</sub> and dark smoke emissions.

#### **4.2. Study 2**

**Pesticides** : All but one of the six farms studied used independent advice to determine pesticide use. This approach minimised the number of applications during the season, particularly on arable and root farms.

Four of the six farms had modern application machinery less than five years old. These modern machines were fitted with electronic flow/area meters with a display in the tractor cab which allowed for accurate calculation of pesticide requirements in relation to field sizes, thus reducing the amount of surplus pesticide left in the tank after applications were completed.

Many of the farms studied had a large amount of pesticide in store and often bought material in a large number of small containers. The use of larger container sizes and matching of orders to requirements would not only give potential cash savings of up to 5%, but also lead to fewer containers being left in store and a reduced number of waste containers to be disposed of. The current practice on all six farms studied was to dispose of all combustible waste pesticide packaging by burning. There is a considerable opportunity for waste recycling in this area: The Producer Responsibility Obligations (Packaging Waste) Regulations 1997 should lead to the introduction of returnable containers by pesticide manufacturers.

**Veterinary Products** : All farms had regular discussions with their veterinary surgeon over drug treatments with the aim of using the most cost effective drugs as appropriate. Generally the person in charge of veterinary treatments had no formal training but years of farming experience. There was no evidence of excess use of

veterinary medicines. However, some opportunities for waste minimisation were identified as follows : Several of the farms were not weighing animals before dosing to calculate accurate dose rates for stock. All farms could implement a more rigorous isolation policy for animals brought on to the farm before mixing with other stock. This would help to reduce the risk of importing disease and ultimately reduce the need for veterinary medicines.

Adoption of better disposal routes for packaging and used needles would eliminate any potential hazards associated with disposal in the rubbish bin along with other wastes.

*Sheep Dip* : The predominant reasons for dipping were prevention of blow fly strike, prevention of sheep scab and control of ticks. Bloom dipping was carried out on two of the six farms where mule ewe lambs were sold in the autumn. All farms were dipping once in the season and some twice. Four of the farms had their own dipping facilities with dip baths ranging in size from 900 to 2025 litres. The age of the baths varied from 8 to 60 years. Half of the farms were using organophosphate dips and the other half were using synthetic pyrethroids.

Spent sheep dip was generally diluted with dirty water or slurry and spread on land. The area of land and application rate was generally not known with any accuracy. Farmers were however taking care to select fields that had no obvious water courses and were apparently suitable for dip disposal.

The frequency of dipping was not excessive on any of the farms and was in accordance with good management practice. However pour-on chemicals have reduced the amount of dipping on 5 out of the six farms over the past few years.

Most farms could increase the length of time allowed for dipped sheep to remain in the draining pens, hence reducing the amount of dip concentrate required for topping up the bath. Isolation of new stock on arrival on the farm for a period of 3 to 4 weeks would reduce the chance of infecting the whole flock, and could therefore reduce the amount of dipping required.

There are only small cost savings to be made by implementing the waste minimisation opportunities identified. Environmental benefits of these would be small.



## **5. Conclusions**

A number of overall conclusions were drawn.

**5.1. General use of waste minimisation in agriculture.** In agriculture, implementing the process of waste minimisation draws together various skills, including agronomy, stockmanship and engineering. Worthwhile opportunities exist for waste minimisation and recycling on farms, but not at the level which has been experienced in other industries. On 10 farms studied, a total of 50 new opportunities were identified. Where savings can be made, the payback period is often less than 3 years. Substantial environmental benefits could occur as a result of suggested changes a number of existing good practices were identified, which could be taken up by others, if appropriate to their farms.. Better agricultural plastics recycling facilities are urgently required, as these materials are often contaminated with soil, crop or other residues.

**5.2. Pesticides, Veterinary Medicines, Sheep Dip.** On the farms on which further case studies were carried out there was little opportunity to reduce the number or rate of applied pesticide sprays on the basis of currently accepted good agronomic practice. However, areas for waste minimisation included the opportunity to reduce the quantity of pesticides in store and improved disposal/recycling of waste containers and packaging.

There was no evidence of excess use of veterinary medicines. However, several of the farms were not weighing animals before dosing to calculate accurate dose rates for stock. Some re-assessment of regularly used vaccines/wormers should be made in an attempt to rationalise drug use. All farms could implement a more rigorous isolation policy for animals brought on to the farm before mixing with other stock. Small environmental benefits might result from such policies.

The frequency of sheep dipping was not excessive on any of the farms and was in accordance with good management practice. However, most farms could increase the length of time allowed for dipped sheep to remain in the draining pens. Isolation of new stock on arrival on the farm for a period of 3 to 4 weeks would reduce the chance of infecting the whole flock, and could therefore reduce the amount of dipping required. More attention to the correct spreading rates for spent dip and considering use of a proprietary additive to aid degradation of spent dip prior to land spreading would help minimise undesirable environmental effects.

## **6. Acknowledgements**

The authors wish to thank those farmers who willingly co-operated in these studies. Funding from The Ministry of Agriculture, Fisheries and Food (MAFF) and The B O C Foundation for both studies, is gratefully acknowledged.

## **7. References**

- (1) Department of the Environment, Welsh Office (1995), A Waste Strategy for England and Wales. Consultation Draft, January 1995.**
- (2) HMSO (1994), Sustainable Development The UK Strategy January 1994**
- (3) Waste minimisation - A route to profit and cleaner production - An interim report on the Aire & Calder Project. CEST. April 1995 ( plus individual case studies).**
- (4) Project Catalyst. W. S. Atkins, March Consulting Group, Aspects International, 54pp, June 1994.**
- (5) NRA (1992) The influence of agriculture on the quality of natural waters in England and Wales Water Quality Series No 3, National Rivers Authority, January 1992.**
- (6) Johnston , N (1993) Cleaner Farming Centre for Exploitation of Science and Technology August 1995**
- (7) MAFF (1988) Reducing Agrochemical Use on the Arable Farm. MAFF Pesticides Safety Division, January 1998**
- (8) NRA (1994) The Disposal of Sheep Dip Waste-Effects on Water Quality. R & D Report No 11 by WRc plc. National Rivers Authority, January 1994**
- (9) Crittenden B. D. and Kolaczowski S. T., Waste Minimisation Guide . 87 pp. Institution of Chemical Engineers. February 1992.**
- (10) Code of Good Agricultural Practice for Protection of Water, 80 pp, MAFF, 1991.**
- (11) Code of Good Agricultural Practice for Protection of Air, 74 pp, MAFF, 1992.**
- (12) Code of Good Agricultural Practice for Protection of Soil 55 pp MAFF 1993**
- (13) Fertiliser recommendations for Agricultural and Horticultural Crops (RB209) 112 pp. Sixth Edition, MAFF 1994**
- (14) Energy Saving Opportunities in Agriculture - An advisory booklet prepared by ADAS for MAFF, April 1996.**

(15) **Spetch A. and Brown S.** (1994) Turning Harvester Losses into Profit Gain, British Sugarbeet Review. Vol 6, No.3, 1994 pp 28-30

(16) **Burnhill P., Chalmers A.G. and Fairgreve J.**, (1994) Fertiliser use on Farm Crops 1993. British Survey of Fertiliser Practice 1994. Fertiliser Manufacturer's Association, MAFF, SOAFD. HMSO 1994.

(17) **ADAS** (1996) Contract ref. CSA 3147- Case Studies of Waste Minimisation on Farms. Report by ADAS to MAFF and The BOC Foundation, June 1996

(18) **BDB Associates** (1996) Agricultural Waste Minimisation, Environment Agency Technical Report, 1996.



## **A survey of toxic organics in Norwegian sewage sludge, compost and manure.**

*Suivi des toxiques organiques dans les boues de station d'épuration en Norvège, dans le compost et les déjections animales.*

**B. Paulsrud, A. Wien and K.T. Nedland**

Aquateam – Norwegian Water Technology Centre AS

P.O. Box 6875, Rodeløkka

N-0504 OSLO. Norway

### **Abstract**

*A survey initiated by the Norwegian environmental authorities, has given updated information about the content of toxic organics in Norwegian sewage sludge, compost and manure. Thirty six monthly composite samples of disinfected, stabilized and dewatered sludge from eight sewage treatment plants were analyzed for dioxins/furans, PCBs, PAHs, alkylphenols, phthalates and LAS (anionic surfactant). The same analytical programme was carried out for 9 samples of compost from source separated organic household waste and 8 samples of cattle and pig manure.*

*The data from this survey was compared to previous Norwegian sewage sludge analyses and to Swedish, Danish and German standards. After an evaluation of all these aspects, the Norwegian authorities have decided not to include limit values for toxic organics in the existing regulations for sewage sludge and compost.*

### **Résumé**

Un suivi mis en place à l'initiative des autorités environnementales norvégiennes a permis d'actualiser l'information existante sur les toxiques organiques présents dans les boues de station d'épuration, les composts et déjections. Trente six échantillons composites de boues désinfectées, stabilisées et déshydratées, issus de 8 sites de traitement, ont été analysés pour les composés suivants : dioxines/furannes, PCBS, PAHS, alkylphénols, phtalates et LAS (surfactants anioniques). Ce même programme analytique a été réalisé sur 9 échantillons de compost issu de déchets ménagers et 8 échantillons de déjections bovines et porcines.

Les données de ce suivi ont été comparées à celles pré-existantes en Norvège et aux données de référence en Suède, Danemark et Allemagne. Après prise en compte de tous ces paramètres, les autorités norvégiennes ont décidé de ne pas inclure de valeurs limites pour les toxiques organiques dans la législation existante sur les boues et composts.

## **1. Introduction**

In January 1995 the Norwegian health and environmental authorities jointly issued a new regulation for sewage sludge treatment and disposal (Ministry of Health and Social Welfare and Ministry of the Environment, 1995). This regulation was amended in September 1996, and the major amendment was a further reduction in the limit values for heavy metal content in sewage sludge to be applied on land areas.

In September 1996 the Ministry of Agriculture launched a revised version of the regulation for the use of organic waste products in agriculture and for land reclamation, parks and lawns. (Ministry of Agriculture, 1996). This regulation covers a wide range of waste products, including compost from source separated organic household waste, growth media containing sewage sludge (max 30% sewage sludge) and organic fertilizers with sewage sludge origin. The sewage sludge and organic waste regulations are harmonised regarding criteria for heavy metal content, but there are no limit values or guidelines for the content of toxic organics.

As a result of media focus during 1995 – 1996, farmers and environmental organisations became increasingly concerned about potential oestrogenic compounds in sewage sludge. This situation forced the authorities to present updated information about toxic organics in waste products spread on agricultural land, and a survey was initiated.

The main objectives of the survey were to :

- present representative data for the content of certain toxic organics in sewage sludge and compost, and to compare these with the corresponding data for animal manure
- compare the data with previous Norwegian analyses of sewage sludge and recent data from Denmark and Sweden, and with the German, Danish and Swedish regulations on toxic organics (organic xenobiotics) in sewage sludge and compost
- evaluate the need for including limits for toxic organics in the Norwegian regulations governing sewage sludge and compost.

## **2. Materials and methods**

### Sewage treatment plants, compost plants and farms included in the survey

Tables 1,2 and 3 present some basic information about the plants and farms included in the survey. The sewage treatment plants were randomly selected among those plants treating both municipal and industrial wastewater and with experience from sludge recycling and the reduction of toxic elements in sewage sludge. The criteria for the selection of composting plants were the use of source separated household waste as the major organic waste to be composted, and that

sewage sludge is not handled. The farms for manure sampling were randomly selected, except that one of them should operate without utilising mineral fertilizers and pesticides ("ecological farming").

#### Selection of parameters to be analysed. Analytical procedures

The following criteria were used to determine the range of compounds to be analysed in the study :

- Listed as a high priority contaminant by the health and environmental authorities
- Detected in fairly high concentrations in the previous (1989) sewage sludge study (Vigerust, 1989)
- Included in other countries sewage sludge or compost regulations or guidelines (Danish Ministry of Environment and Energy, 1996; Der Bundesminister für Umwelt, Naturschutz und Reaktorsicherheit, 1992; National Swedish Environmental Protection Board, 1994)
- Certain limits for the total cost of laboratory analyses

Six main groups of organic compounds were selected based on the given criteria :

- dioxins/furans, PCDD/PCDF (17 compounds), PCBs (7 congeners), PAHs (16 compounds), alkylphenols (nonylphenol/-ethoxylates + 2-methylphenol + 3/4-methylphenol), phthalates (DEHP + DBP) and linear alkylbenzene sulfonates (LAS).

Eight Scandinavian laboratories were invited to tender for provision of the laboratory services, and the successful laboratories were the Norwegian Institute for Air Research and the Swedish KM Lab. Table 4 summarises some key information about the analyses performed.

- The method refers to an internal, accredited procedure of the Norwegian Institute for Air Research
- Refer to publication no. 3829 from the National Swedish Environmental Protection Board (SNV) (1990)
- Apply to each of the PCB congeners and the sum of 6 PAH compounds
- Apply to the sum of 7 PCB congeners and the sum of 6 PAH compounds
- These two analyses were not accredited.

Plant n°	Plant size (actual load, p.e.)	Sewage treatment process	Coagulant for P-removal	Sludge treatment process <sup>1)</sup>
1	250,000	Primary – chemical	Fe – chloride	Anaerobic digestion
2	75,000	Primary – chemical	Fe – chloride	Pre-pasteurisation + anaerobic digestion
3	65,000	Biological – chemical	Alum	Thermal hydrolysis + anaerobic digestion + thermal drying
4	81,000	Primary – chemical	Fe – chloride	Pre-pasteurisation + anaerobic digestion
5	75,000	Primary – chemical	Al-chloride (prepol.)	Indoor windrow composting with bark
6	67,500	Primary – chemical	Fe – chloride	Lime treatment
7	480,000	Biological – chemical	Al-chloride (prepol.)	Anaerobic digestion + lime conditioning
8	40,000	Primary – chemical	Fe – chloride	Thermophilic aerobic pre-treatment + anaerobic digestion

<sup>1)</sup> All plants included in the survey employ both gravity thickening and mechanical dewatering in addition to the processes listed in the table.

*Table 1  
Sewage Treatment Plants Included in the Survey*

Plant n°	Type of composting plant	Organic waste to be composted	Bulking agents
1	In vessel (reactor)	Source separated household waste	Bark + garden waste
2	In vessel (reactor)	Source separated household waste	Wood chips + garden waste
3	Windrow	Source separated household waste + some horse manure	Mainly garden waste + some bark and wood chips
4	Windrow	Source separated household waste included nappies	Garden waste
5	Windrow	Source separated household waste included nappies	Garden waste
6	Windrow	Source separated household waste included nappies	Garden waste
7	Windrow	Kitchen waste from hotels and restaurant	Garden waste
8	Windrow	Source separated household waste	Garden waste
9	Windrow	Source separated household waste + some poultry manure	Garden waste + wood chips

*Table 2  
Composting Plants Included in the Survey*

Farm n°	Way of operation	Type of manure
1	Ecological	Cattle
2	Conventional	Cattle
3	Conventional	Pig
4	Conventional	Cattle

*Table 3  
Origin of Manure Included in the Survey*



Parameter	Method	Detection limit	Uncertainty
PCDD/PCDF	GC-MS, NILU – 0 – 1 <sup>1)</sup>	0,1 ng/kg dw	± 25%
PCBs	GC-MS, SNV 3829 (mod.) <sup>2)</sup>	0,001 mg/kg dw <sup>3)</sup>	± 20% <sup>4)</sup>
PAHs	GC-FID/MS, SNV 3829 (mod.) <sup>2)</sup>	0,1 mg/kg dw <sup>3)</sup>	± 30% <sup>4)</sup>
Alkylphenols	GC-ECD/MS, SNV 3829 (mod.) <sup>2)</sup>	1 mg/kg dw	± 34%
Phthalates	GC-MS/SNV 3829 (mod.) <sup>2)</sup>	1 mg/kg dw	± approx. 30% <sup>5)</sup>
LAS	Standard methods 555C (mod.)	1 mg/kg dw	± approx. 30% <sup>5)</sup>

*Table 4  
Analytical methods, detection limits and uncertainties*

### Sampling procedures

All sampling equipment (gloves, spoons, containers) were selected and prepared by the laboratories to avoid contamination of the samples, and detailed instructions were worked out on how to perform the sampling of the different materials at each plant/farm.

The sewage sludge samples were taken as monthly composite samples from each plant in the period Oct. 1, 1996 – Febr. 28, 1997. These samples were composed of approx. 30 daily composite samples representing each days production of treated sludge ready for land application. All samples were kept frozen until they were analysed.

Only one compost sample from each composting plant was taken during the period Dec. 96 – Jan. 97. These samples were made up of about 10-20 grab samples from different places in the heaps of compost ready for delivery. All samples were transported directly to the laboratories without any conservation (freezing).

Samples of animal manure were taken as grab samples from the slurry tanks, and each farm was sampled twice within a period of about one month during Dec. 1996. These samples were frozen prior to analysis.

### **3. Results and discussion**

Table 5 presents a comparison between this study and previous Scandinavian investigations of toxic organics in sewage sludge. Figure 1 compares the levels of toxic organics in sewage sludge, compost and manure measured in this study.

Parameter	Investigations	No. of samples	Range	Median	References
Dioxins/furans (ng i-TE/kg dw)	This study	36	3,0 – 68,8	6,26	National Swedish Environmental Protection Board, 1992 Tørsløv et. al., 1997
	Swedish(1989-91)	14	5,7 – 115	20,5	
	Danish (1993-94)	9	10,3 – 34,2	–	
PCBs (Sum of 7 PCB congeners) (mg/kg dw)	This study	36	0,0168 – 0,0996	0,0422	National Swedish Environmental Protection Board, 1995 National Swedish Environmental Protection Board, 1992 Tørsløv et. al., 1997 Tørsløv et. al., 1997
	Swedish (1993)	23	0,0006 – 0,232	0,113	
	Swedish(1989-91)	27	0,080 – 7	–	
	Danish (1995)	20	<0,027 – 0,186	–	
	Danish (1993-94)	9	<0,030 – 0,140	–	
PAHs (Sum of 16 PAH compounds) (mg/kg dw)	This study	36	0,7 – 30	3,9	Vigerust, 1989 National Swedish Environmental Protection Board, 1995 National Swedish Environmental Protection Board, 1992 Tørsløv et. al., 1997 Tørsløv et. al., 1997
	Norwegian (1989)	19	<1,0 – 24 <sup>1)</sup>	<1,0 <sup>1)</sup>	
	Swedish (1993)	23	<0,3 – 4,9 <sup>2)</sup>	2,0 <sup>2)</sup>	
	Swedish(1989-91)	27	24 – 199 <sup>2)</sup>	–	
	Danish (1995)	20	<0,01 – 8,5 <sup>3)</sup>	–	
Nonylphenol (+ ethoxylates) (mg/kg dw)	This study	36	22 – 650	136	Vigerust, 1989 National Swedish Environmental Protection Board, 1995 National Swedish Environmental Protection Board, 1992 Tørsløv et. al., 1997 Tørsløv et. al., 1997
	Norwegian (1989)	19	25 – 2298	189	
	Swedish (1993)	23	23 – 171	82	
	Swedish(1989-91)	27	44 – 7214	825	
	Danish (1995)	20	0,3 – 67	8	
Phthalate, DEHP (mg/kg dw)	This study	36	<1 – 140	58	Vigerust, 1989 National Swedish Environmental Protection Board, 1992 Tørsløv et. al., 1997 Tørsløv et. al., 1997
	Norwegian (1989)	19	27 – 1115	83	
	Swedish(1989-91)	27	25 – 661	170	
	Danish (1995)	20	3,9 – 170	24,5	
	Danish (1993-94)	9	17 – 120	38	
LAS (mg/kg dw)	This study	36	<1 – 424	54	Tørsløv et. al., 1997 Tørsløv et. al., 1997
	Danish (1995)	20	11 – 16100	530	
	Danish (1993-94)	6	200 – 4640	455	

1 Sum of 10 PAH compounds

2 Sum of 6 PAH compounds

3 Sum of 18 PAH compounds

**Table 5.**  
**Comparison of Scandinavian Investigations of Toxic Organics in Sewage Sludge**

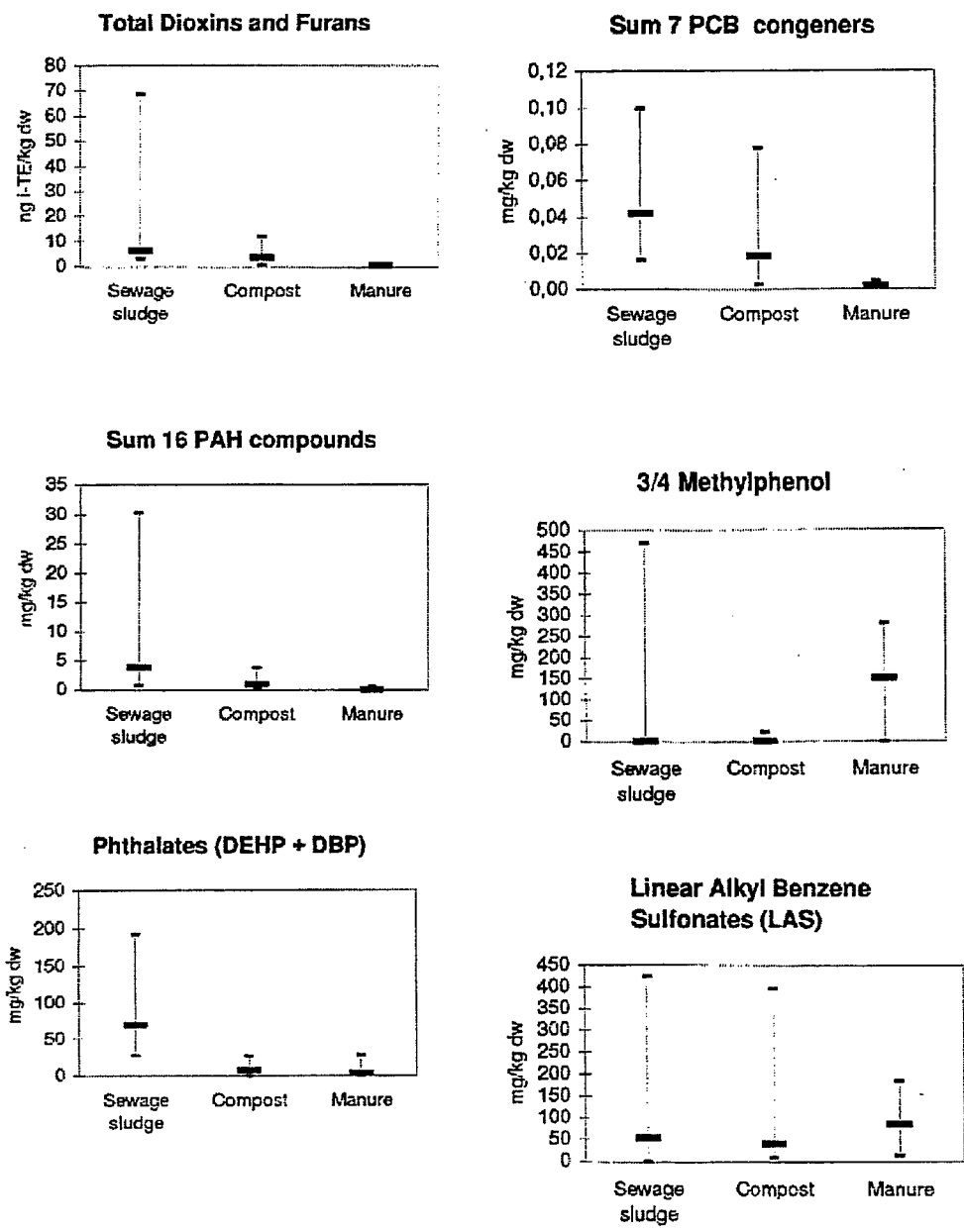

**Figure 1**  
 Comparison of toxic organics in Norwegian sewage sludge, compost and manure (minimum, median and maximum values).

### **3.1. Dioxins/furans (PCDD/PCDF)**

The concentration of PCDD/PCDF in the sewage sludge was in general very low and showed only small monthly variations. Only one plant (# 7) had real peak values, but still they were below the maximum values in the German standard.

### **3.2. PCBs**

The PCB content of the sludge samples was low and, in general, lower than that found in previous studies in Scandinavia. However, there were great variations between monthly samples from each plant, and in fact greater than between samples from the different plants. All values were far below the German and Swedish standards for PCB.

### **3.3. PAHs**

The PAH content was low in most sewage sludge samples and well below the Swedish and Danish standards (as of 1997). However one plant (# 3) exhibited high values in 4 of 5 samples, and one sample from plant 6 was over the standards. The PAH concentrations measured in this study are almost at the same level as in the previous Norwegian investigation (Vigerust, 1989), but above the more recent values reported in Sweden and Denmark (National Swedish Environmental Protection Board, 1995; Tørsløv et al., 1997).

Some of the compost samples had PAH contents as high as the best sludge samples, but in general they were much lower, and the manure samples didn't show PAHs above the detection limits except two samples.

### **3.4. Alkylphenols**

Nonylphenol (+ ethoxylates) were found in high concentrations in sludge samples from all the sewage treatment plants in the survey, and all the plants would have been classified as non-compliant with the Swedish and Danish standards. There has only been a minor decrease in nonylphenol concentration in Norwegian sludges since 1989, while Sweden and Denmark have experienced a much greater reduction during the nineties. This is mainly due to their exertion of pressure on the industries to phase out these compounds from their products (i.e. detergents, paints). Similar experiences have been reported from Switzerland (Giger, 1997). No nonylphenol (+ ethoxylates) has been detected in any of the compost and manure samples in this study.

3/4 methylphenol (m-/p-cresol) were detected in fairly high concentrations in manure from all farms, while only one sewage treatment plant (# 3) gave similar (or higher) concentrations in the sludge. These compounds are intermediates in the decomposition of amino acids in man and animals, and will rapidly decompose further under aerobic conditions.

### 3.5. Phthalates

DEHP was detected in almost all sewage sludge samples, and three of the plants revealed concentrations above the Danish 1997-standard. DBP was detected less frequently and also at lower concentrations than DEHP. There has been a significant reduction in DEHP content of Norwegian sludges since 1989, but the values are still higher than in the Danish investigations. Both DEHP and DBP were also found in compost and manure, but at lower levels than in sewage sludge.

### 3.6. LAS

The LAS content of sewage sludges in this study was very variable, but in general the values are far below the Danish standard and the concentrations reported in the Danish investigations (Tørsløv et al., 1997). This is mainly due to the fact that most Norwegian households use eco-labeled detergents, indicating that they do not contain LAS. These compounds were also found in compost and manure at similar levels to the sewage sludge.

## 4. References

**Danish Ministry of Environment and Energy (1996).** Statutory Order No. 823 of 16 September 1996 on use of waste products in agriculture (in Danish)

**Der Bundesminister für Umwelt, Naturschutz und Reaktorsicherheit (1992)** Klärschlammverordnung (Abf Klär V) vom 15. April 1992. Bundesgesetzblatt, Teil I, No. 21, 912-934

**Ministry of Agriculture (1996)** Regulation on the sales of organic fertilizers, soil improvement products and growth media. Oslo (in Norwegian)

**Ministry of Health and Social Welfare and Ministry of the Environment (1995).** Regulation for handling and disposal of sewage sludge, Oslo (in Norwegian)

**National Swedish Environmental Protection Board (1990)** Sampling and analytical methods for sewage sludge. Report No. 3829 (in Swedish)

**National Swedish Environmental Protection Board (1994)** Order on protection of the environment, especially farmlands, when sewage sludge is used in agriculture. 30 May 1994 (in Swedish)

**National Swedish Environmental Protection Board (1995)** Large sewage treatment plants. Sludge and wastewater. Actual situation in 1993. Report No. 4423 (in Swedish)

**Paulsrud, B. (1997)** Strategy for land application of sewage sludge in Norway. Wat Sci. Tech., Vol. 36, No. 11, pp. 283-290

**Tørsløv, J.; Samsøe-Petersen, L.; Rasmussen, J.O. and Kristensen, P. (1997)**  
Use of waste products in agriculture. Contamination level, environmental risk assessment and recommendations for quality criteria. Environmental Project No. 366, Danish Environmental Protection Agency

**Vigerust, E. (1989)** Organic micropollutants in Norwegian sewage sludge. Norwegian State Pollution Control Authority, Oslo (in Norwegian)

# **Animal slurry management and lombard regulations an example of application.**

*Réglementations sur la gestion des déjections animales  
en Lombardie : un exemple d'application.*

**G. Provolo, F. Sangiorgi.**

*Istituto di Ingegneria Agraria, University of Milan, Via Celoria 2,  
20133 Milano, Italy*

E-mail : gprovolo@imiucca.csi.unimi.it

## **Abstract**

*The Regional Act n° 37/93 is, at least for the Italian habits, very advanced because it considers for the first time the concept that all the farms with animals must submit a plan for agronomic utilisation of slurry. This plan must be prepared by using a special software (GIARA37) and circulated on floppy disk, for the approval by the different organisations involved. An investigation was carried out in three communes around Lodi, which is a significant and illustrative area of Lombard farming. The results obtained highlighted that in the area considered about 250.000 m<sup>3</sup> of slurry are produced every year, which means a load of 100 m<sup>3</sup>/ha. Another 48.500 tons of manure (20 t/ha) need to be added, which it makes a total of 645 t (260 kg/ha) of nitrogen. Since the quantity of nutrient required is 950 t, one can observe, generally speaking, that the relationship between slurry production and fields on which to spread it is not contradictory.*

Keywords : legislation, manure handling, catchment areas

## **Résumé**

L'Acte Régional n°37/93 est, compte-tenu des habitudes italiennes, relativement nouveau car il considère pour la première fois le concept d'équilibre agronomique des éléments et du plan d'épandage. Ce plan doit être utilisé suivant un logiciel spécifique (GIARA37) et doit circuler dans sa version fichier-disquette pour approbation par les différentes parties impliquées. Une investigation pilote a ainsi été effectuée sur 3 communes représentatives des pratiques d'élevage en Lombardie. Les résultats obtenus soulignent que dans la zone considérée, environ 250 000 m<sup>3</sup> de lisier sont produits annuellement, ce qui conduit à un apport moyen de 100 m<sup>3</sup>/ha. De plus, 48 500 tonnes de fumier (soit 20 t/ha) doivent également être pris en compte dans ce bilan de fumure, ce qui aboutit à un total de 645 t. d'azote (soit 260 kg/ha). Compte-tenu de l'estimation en besoins en azote, soit 950 t., la relation entre production de déjections et les terres sur lesquelles les épandre n'apparaît pas conflictuelle.

Mots-clés : législation, manipulation et gestion des déjections, bassin versant.

## Foreword

Since the war the production system in the Po Valley has deeply changed, which has affected production and slurry disposal procedures. As a general consequence farmers have stopped to consider slurry as a nutrients source and started to manage slurry disposal in a more casual way. Agriculture, and animal husbandry in particular, have then been blamed as the main responsible for non point pollution.

Act 37/1993 of the Lombardy Region aims at providing guidelines on how to process and utilize animal organic residues in order to improve soil fertility and water quality. Within the region areas with different animal load and soil profiles have been selected with the aim to establish a rank order for the implementation of the act and for the more or less detailed plan to be submitted to the Local Authorities. The aim of the above-mentioned Act is to urge farmers to utilize slurry in an agronomically correct way.

Here are the main features of the Act :

- to select areas with the highest animal load and to find a relationship between those areas and the soil;
- to improve or to keep at its best soil fertility thanks to an evaluation of crop requirements;
- to measure how much slurry needs to be spread on the basis of crop requirements and nutrients content of the slurry;
- safeguard surface and ground waters thanks to the correct management of slurry;
- to limit foul odours thanks to slurry treatment;
- to set up Manure Management Plans of which specially trained technicians will be in charge.

Using slurry in an agronomically correct way may be considered obvious, but it is not; in fact huge sums of money have been invested to finance ad hoc researches in these last few years. The main problem is to establish if and to what extent the agronomic use of slurry is responsible for the pollution of surface and ground waters. On this condition depends the viability of administrative or judiciary measures.

The Act and its implementation guidelines put the responsibility on farmers and technicians, but also on who have to issue local authorities permissions. Local Authorities, in particular, become the real soil managers, since they collect data and issue permissions only after STAP (Agricultural Advisory Service) technicians have given their approval of the structural and managerial aspects of the farm, and the Local Health Inspectors have made sure that there are no pollution hazards of surface and ground waters and have set limits if there are wells or houses in the surrounding area.



### *How the Act affects the area*

One of the main features of Regional Act 37 is that information on slurry management is collected in a systematic way. Having this information is the condition to manage the soil in an environmentally friendly way, at least as far as pollution from agriculture is concerned.

In fact, in order to reduce the environmental impact, slurry management at regional level needs to take into account the following aspects :

- analysis of the situation in the region and assessment of the polluting load in consideration of agricultural practices;
- selection of micro-catchment areas and definition of the pollution risk for every one of them;
- plan of operations the priorities of which will be based on the risk level of every micro-catchment area and on policies to be outlined. Measures can be structural (i.e. storage pits) or managerial (adoption of agronomic practices and/or of suitable spreading systems);
- monitoring of surface and ground water characteristics and evaluation of the impact of structural and managerial measures. Some measures may have an effect only in the long term (after 10-15 years).

In order to implement Act 37/93 farmers are expected to submit a Manure Management Plan of animal slurry (PUA), even in a simplified version (PUAS), when the farm load of live weight per hectare is lower than the one accepted for the area.

The aims of the plan are the following :

- to set up a file of the farms, containing information on the farm and the soil where slurry is spread;
- to analyse the most common situations and those at a greater risk, while providing technical solutions to reduce pollution risks;
- to urge farmers to use slurry in an agronomically correct way, yet avoiding to do so when the situation is incompatible;
- to highlight structural deficiencies as far as slurry management is concerned and to put forth solutions supported by incentives.

In order to achieve those aims it is necessary to know all the details about the farms before outlining policies, which have to be evaluated from a technical and economic point of view by means of simulation models. Thus it will be possible to obtain data indicating the best agronomic practices to adopt and the necessary structural policies to implement in order to reduce the risk of pollution as much as possible. Moreover the collection of data will help to select micro-catchment areas at risk on which to focus attention.

It must be emphasized that an extension service needs to be set up so that farmers will be provided of the necessary technical information to manage nutrients (organic and mineral) correctly.

It is necessary to keep in mind that the guidelines require the use of a special software (GIARA 37) for data collection and the processing of manure management plans. Thus information will circulate and will be checked by means of computers, instead of using paper. The most important consequence is that it will be possible to assess the quantity of nutrients let into surface and ground water.

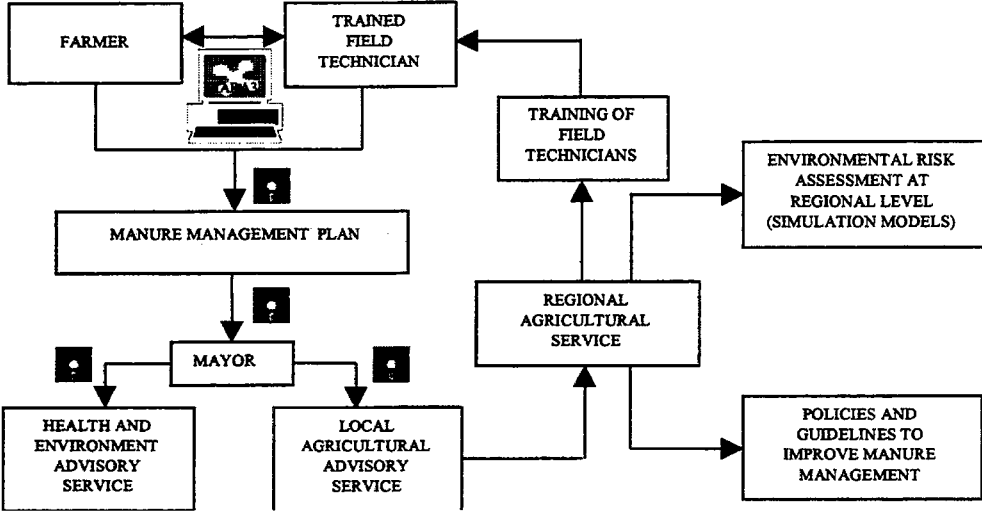

Figure 1. Implementation of Act 17/93.

*An example of implementation*

In order to evaluate the potential of Regional Act 37, a survey was carried out in three Lodi communes, which is a representative area of the whole of Lombard husbandry.

The collection of farm data (agronomic and management) was carried out thanks to a survey conducted with farmers, who volunteered provide those data. The operational outline was based on the implementation suggested by Act 37 guidelines.

As for the methodology used to measure crop requirements, in order to define the crop rotation pattern each farm area was identified on maps and the use of every single plot was recorded (the farmer declared the use).

The average nitrogen loss was taken down so as to assess the quantities of nutrients (nitrogen, phosphorus and potassium) to be spread along with organic or mineral fertilizers in order to meet crop requirements in every farm.

The basic information used to measure volumes and define slurry characteristics concerned the animal category (growing phase and live weight) and type of stabling. This information, provided by farmers themselves, made it possible to measure volumes and define nutrients content in the slurry on the basis of the implementation policy.

The final result is that the quantities of slurry and manure to be spread and the quantities of nutrients produced can be defined.

The balance between the quantities of nutrients in the slurry and crop requirements has made it clear if farms can spread slurry without putting the environment at risk because of nutrients surplus.

In order to manage slurry in a correct way, adequate storage pits are necessary. Their size depends not only on the volume of slurry, but also on the time of year when it is spread. They also depend on the type of crop and, somehow, on the spreading techniques.

To take those factors into account when planning storage pits, the volumes of slurry spread in the various months of the year were calculated after farmer's indications. For every crop requirements and expected amounts of slurry to be spread were also taken into account. It was then possible to obtain a farm spreading schedule showing the periods when spreading had to be carried out (crops and spreading techniques) and the amounts of slurry necessary to meet crop requirements.

On the basis of these schedules and considering that the production is constant throughout the year, the necessary storing volumes were calculated.

### ***Results obtained after schedule planning***

On the basis both of the data collected in every farm and of Manure Management Plans, all data were again processed so as to better clarify the problem posed by slurry in the area considered.

The average load of slurry produced, 104 m<sup>3</sup>/ha, makes it possible to state that the situation does not pose any problem as far as the quantities of slurry and the amount of nutrients to be spread are concerned (the general covering level of organic nitrogen is 68%).

At least 1/3 of the farms located in the study area for a total surface of 1,300 ha, spread more than 100 m<sup>3</sup>/ha; the areas to be spread with great quantities of slurry (40 t/ha) are only 225 ha. As for spreading period, peaks are to be found in March

and October, with a small peak in June in the permanent meadow area (Fig. 2a). This period coincides with the wettest months, which poses serious tactical and strategic problems as to the procedures to follow in order to make the most of the fertilising value of slurry and reduce pollution risks from run-off or leaching.

If spreading periods are considered (Fig. 2b) it should be noted that the most slurry is spread between October and November whereas in March a smaller quantity is spread. Fall spreading is connected with winter crops (mainly *Lolium italicum*).

As for the spreading period of mineral nitrogen (Fig. 2c), it can be noticed that the peak is between May and July and that the quantities spread in Fall (especially October) are very small.

Once the crop rotation has been defined in every farm the theoretical requirement of nitrogen was calculated. This figure was compared with the slurry nitrogen content and, afterwards, with the total mineral manure used. The areas with the excess content were the following: 100 kg/ha on 333 ha; 100-200 kg/ha on 1256 ha; 200 kg/ha on 768 ha.

Once the total volume of the slurry produced, the amount of stored slurry and the crop rotation were known, four groups were created including all possible combinations: adequate slurry production and facilities; inadequate facilities and adequate slurry production; adequate facilities and excess slurry; inadequate facilities and excess slurry (Fig. 3).

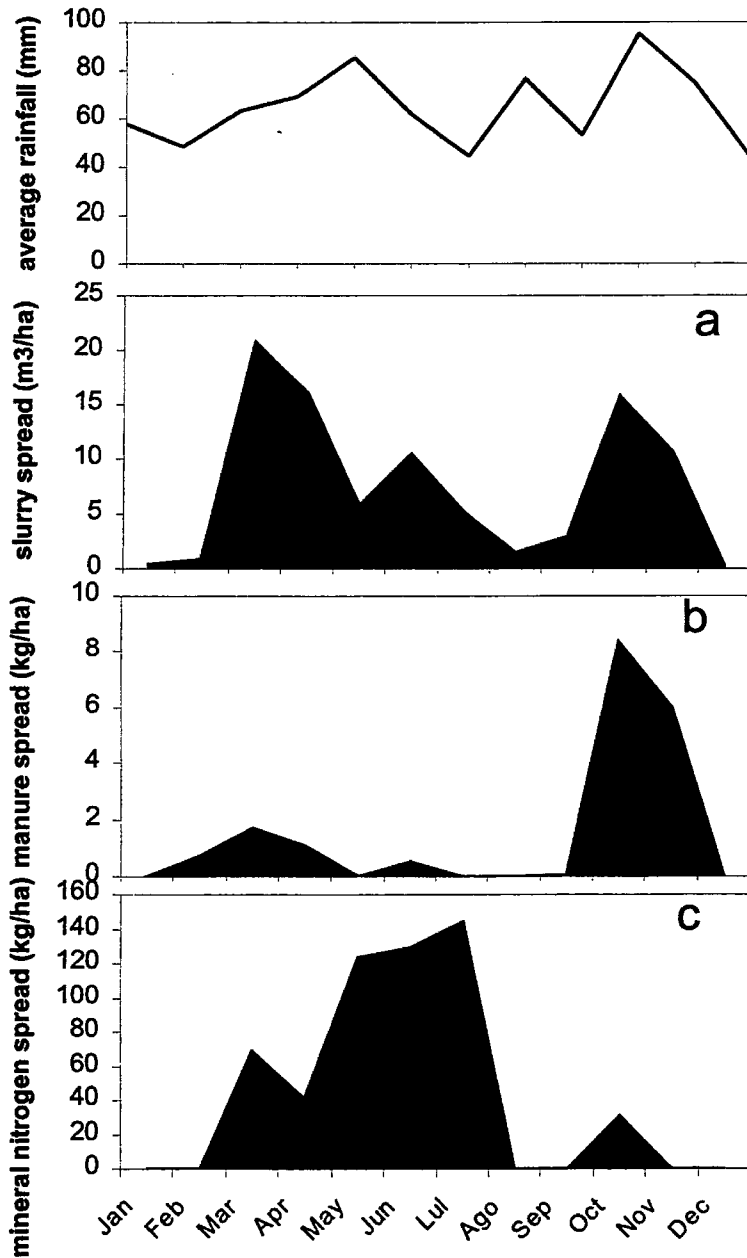

**Figure 2**

*Amount of liquid manure (slurry), solid manure and mineral nitrogen spread in the studied area in the various months of the year, also in relation to average rainfall.*

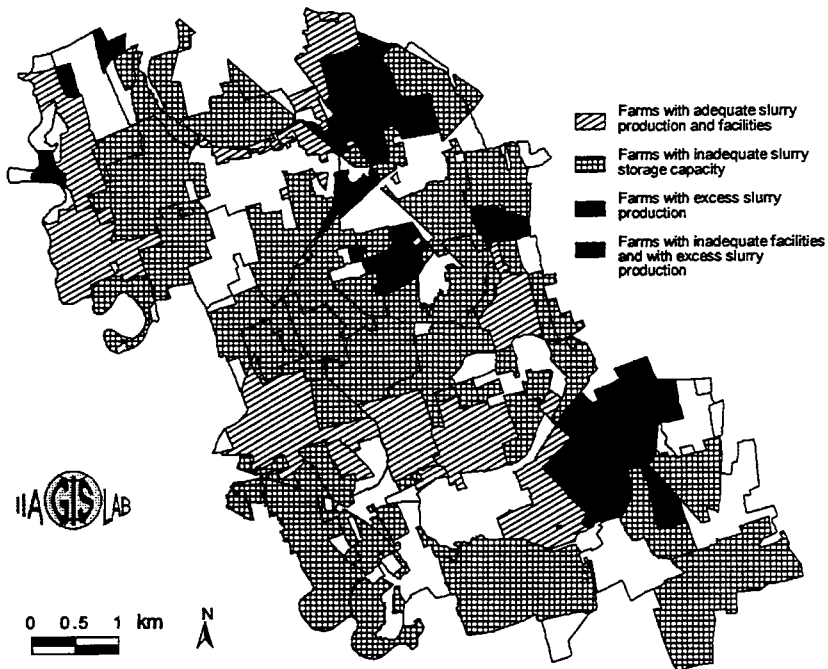

*Figure 3*  
*Conditions of the farms in the study area in relation to the slurry storage capacity and the amount of slurry produced.*

## Conclusions

The problems posed by the pollution of surface and ground waters require that the responsibilities of each sector involved should be clearly defined.

The aims of the Regional Act 37/93 and its implementation guidelines are: i) to promote the correct agronomic use of slurry through PUA and PUAS; ii) to set up a monitoring system of the environment based on the processing of PUA and PUAS data, that will be entered into models defining nutrient outlet into surface and ground waters.

PUA (and PUAS) require cooperation between farmers and technicians. In the future more technicians should work with farmers and Lombard agriculture should benefit from it. The Regional Act 37/93 and its implementation guidelines provide a complete tool for a better and more correct utilization of animal slurry with less environmental impact, also thanks to the development of technical guidance. The system is undoubtedly complex and ambitious. It will be successful if every party (farmers, technicians, Public Advisory Service, Health Inspectors) cooperate.

## References

**Cumby T., O.T. Carton, G. Eftichidis, G-J. Monteny, G. Provolò, F. Sangiorgi, F.J. Wolak**, An expert system for tackling farm waste problems, Proceedings of the Conference on "New strategies for sustainable rural development, Special Volume of *Bulletin of the Gödöllő University of Agricultural Sciences*, Gödöllő (Hungary), 22-25 marzo 1993.

**Provolò G., Sangiorgi F.**, National and European Legislation for an Expert system in Farm Management, FAO Seventh consultation on "European Cooperative Research Network on Animal Waste Management", Bad Zwischenahn, Germany, 17-20 May 1994. J.E. Hall (ed), 327-332.

**Sangiorgi F., Krause K.H.**, Processing and handling at farms - in Atti "Conferenza Europea su Ambiente, Agricoltura e Zootecnia" - Mantova, 1991.





# Effect of housing system, litter versus totally slatted floor, on mass balances of water, nitrogen, and phosphorus in growing-finishing pigs.

*Effet du système d'élevage, litière contre caillebotis intégral, sur le bilan en eau, azote et phosphore, lors de l'engraissement de porcs.*

Paul Robin<sup>(1)</sup>, Paulo Armando Victoria de Oliveira<sup>(1, 2)</sup>, Daniel Souloumiac<sup>(1)</sup>, Christophe Kermarrec<sup>(1, 3)</sup>, Jean-Yves Dourmad<sup>(4)</sup>.

<sup>(1)</sup> I.N.R.A. Bioclimatologie. 65, rue de St Brieuc. 35042 Rennes Cedex. France.  
e-mail : [probin@roazhon.inra.fr](mailto:probin@roazhon.inra.fr)  
Tel : (33) 02 99 28 52 23

<sup>(3)</sup> E.N.S.C.R. - C.N.G.E.  
Avenue du Général Leclerc.  
35700 Rennes. France.

<sup>(2)</sup> E.M.B.R.A.P.A. Suínos e Aves,  
Caixa postal 21.  
89700 Concordia. Brésil.

<sup>(4)</sup> I.N.R.A. Station de Recherches  
Porcines.  
35590 Saint-Gilles. France.

## Abstract

*The two objectives of this study were first to check the feasibility of continuous composting with saw dust litter, and second to compare the mass balances of both systems (pig-on-litter versus slatted floor). Two replicates of 24 pigs each were used in the experiment. The same climate was maintained in both systems (pig-on-litter versus slatted floor). The amounts of food and water consumed, and the slurry produced were weighed, and their contents in H<sub>2</sub>O, N, and P were determined. The air flow rate and the air concentrations of H<sub>2</sub>O, NH<sub>3</sub>, and N<sub>2</sub>O were also measured continuously. The composting process in the litter system volatilised almost 70% of N excreted as N<sub>2</sub>, whereas with slatted floor most of N volatilised was lost as NH<sub>3</sub>. It is concluded from water and nitrogen mass balances that the pig-on-litter system allows an efficient and environment friendly production of pigs.*

## Résumé

Les deux objectifs de cette étude étaient d'abord de vérifier la faisabilité du compostage continu avec litière sur sciure et deuxièmement de comparer les bilans matières des deux systèmes (litière versus caillebotis). Deux salles de 24 porcs chacune ont été suivies. La même ambiance dynamique a été maintenue dans les deux systèmes. Les quantités d'aliment et d'eau ingérées et le lisier produit ont été pesés, et leur contenu en H<sub>2</sub>O, N et P a été déterminé. Le flux d'air et les concentrations en H<sub>2</sub>O, NH<sub>3</sub> et N<sub>2</sub>O ont également été mesurés en continu. Le procédé de compostage avec litière volatilise environ 70% de l'azote excrété sous forme N<sub>2</sub>, alors que le système caillebotis volatilise l'azote sous forme d'ammoniac (NH<sub>3</sub>). Il est donc conclu à partir du bilan en eau et en azote que le système sur litière permet une production efficace et protectrice de l'environnement.

# 1. Introduction

Waste management strategies are needed in almost all regions of the world that are specialized in intensive livestock production, either because of the volatile elements and the resulting air pollution, or because of the non-volatile elements that accumulate in the soils when they are not exported by the crops or lost in water. Depending on the countries, the present legislations focus on water protection, nitrogen emissions (ammonia  $\text{NH}_3$ , nitric oxide  $\text{NO}_x$ , nitrous oxide  $\text{N}_2\text{O}$ ) or phosphorus enrichment in the soils. Part of the management strategy of the organic wastes begins within the livestock building, during animal growth. They are two main breeding systems: slatted-floor or litter. The litter systems allow a dry and aerobic processing of the slurry (Chan et al, 1994), close to composting, while the slatted-floor systems allow a liquid and anaerobic conservation of the slurry. In pig production the slatted-floor systems are the most common. In those systems, efficient strategies were already proposed. They are based on the dilution of the slurry and the reduction of the emitting surfaces within the building in order to reduce the ratio of the nitrogen gas emissions to the nitrogen excreted. On the contrary, the composting process of the litter during pig production is not always successful in the temperate and cold regions of Europe. The early composting of slurry during the animal growth leads to the elimination of water and nitrogen through gas emissions while non-volatile compounds like phosphorus or heavy metals are concentrated.

Klooster & Greutink (1992) and Oliveira et al (1998) showed that the litter increases the evaporation of water. However, when the litter is not successfully managed, the water excreted accumulates in the litter, it becomes moist and the composting process stops. This is one of the major problems met during pig production on deep-litter. For this reason, our first objective was to check the continuous composting of the litter, i.e. the evaporation of almost all of the water excreted. Lesguiller et al. (1995) showed the dry matter reduction of slurry, thus reducing the costs of storage and transport. The composting process leads to the elimination of dry matter, mostly as  $\text{CO}_2$  and  $\text{H}_2\text{O}$ , thus decreasing the C/N ratio. However, we did not find in the literature a rigorous comparison of the mass balances of both systems. Souloumiac (1995) stressed on the evidence that heat and mass emissions from livestock building depend on the 'Climate-Building-Animal' system. For this reason our second objective was to compare the mass balances in deep-litter and slatted-floor system, all three components kept identical.

Bonazzi & Navarotto (1992) and Lesguiller et al. (1995) showed that the litter accumulated more phosphorus than nitrogen, thus suggesting that more nitrogen is lost as gas emissions than in traditional slatted-floor systems. Moreover, Groenestein et al. (1996) measured higher emissions of  $\text{NH}_3$ ,  $\text{NO}_x$  and  $\text{N}_2\text{O}$  than traditional slatted floor system. A rigorous comparison of housing systems should include measurements of both gas emissions and storage in the litter or the slurry, since other emissions may occur during further processing of the organic wastes (storage, spreading, etc.). Thus, we monitored the litter composition and gas emissions.

## 2. Materials and method

Two identical breeding cells equipped with the same feeding systems were kept in the same climatic environment (Fig. 1). Two replicates each with 24 pigs (30-100 kg live weight) randomly assigned to the two treatments were used, only differing the external climate and the initial composition of the litter. The surface allocated to the pigs was respectively 0.65 m<sup>2</sup> on slatted floor, and 1.10 m<sup>2</sup> on deep-litter. The pigs were cross-bred Piétrain x Large White. They were fed ad libitum with a commercial finishing diet (3200 kcal/kg digestible energy, 16% crude protein). The litter used in the first replicate was transferred from a commercial building. It was disposed as a 80 cm deep layer; the surface 30cm were turned once per week. Dry sawdust was added before the second replicate (512 kg sawdust + 329 kg wood shavings) in order to increase the C/N ratio. Food and water were daily weighed (Metler, 120±0.05kg). Pigs, slurry and litter were weighed at the beginning and at the end of each replicate. Food, litter and slurry were carefully sampled and analysed for dry matter, nitrogen and phosphorus. All mass measurements and chemical analysis had an accuracy higher than 5%. The outside temperature was reduced during the second replicate because most of the management problems with the litters occur during the colder periods in European countries and in order to increase the gas gradients. The mass balance was checked assuming an animal retention of 10% of the water intake, 33% of the nitrogen intake, and 49% of the phosphorus intake (Lesguiller *et al*, 1995).

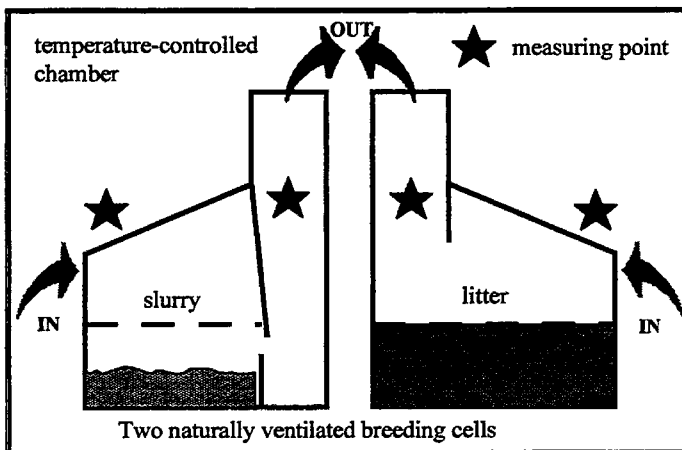

Figure 1  
Experimental design.

Temperature, air humidity, and air speed of exhausted air were monitored at a one minute time step and hourly mean values were stored by a datalogger (AOIP SA120). Air speed was measured with hot-wire anemometers (TSI, 8450) where dust was regularly removed. Ammonia (NH<sub>3</sub>) and nitrous oxide (N<sub>2</sub>O)

concentrations were measured continuously outside and in the air extraction of the cells with a 3426 gas monitor (Bruël & Kjaer). Measurements were made during 30 minutes; only the homogeneous values in the center of the time interval were used to calculate the mean concentration; every two hours (four sampling points). NOx concentrations were checked to be negligible with Draeger tubes. Gaseous fluxes were estimated at a hourly time step. Daily means were calculated only with the observed data of the day concerned.

### 3. Results

We present in Table 1 the global inputs and outputs of the two replicates and the two treatments. The small differences between the initial and final weights of the pigs show that the differences between the animal metabolism in each group remained less than 10%. The food consumption was also similar while the water consumption was slightly less with the slatted-floor. For slatted-floor treatment of second replicate, we met some zootechnical problems: growth was slightly more heterogeneous, the pigs bite themselves. The slurry production in the slatted-floor treatment was similar in the two replicates. The weight variation of the litter during one replicate was negative in the first replicate and positive in the second replicate. The mass variations of the two treatments were different in both replicates.

	Replicate I		Replicate II	
	Slatted-Floor	Deep-Litter	Slatted-Floor	Deep-Litter
<b>Pigs</b>				
Initial weight (kg)	29.8±1.2	30.5±1.4	31.5±1.7	31.6±1.4
final weight (kg)	99.9±7.5	102.3±8.0	95.6±12.6	94.0±10.3
mortality	0	0	2 <sup>1</sup>	0
<b>Food intake</b>				
food (kg/cell)	2276	2301	2238	2210
water (kg/cell)	5084	5357	4605	5225
<b>Litter and slurry</b>				
initial weight (kg)	0	7110	501 <sup>2</sup>	5155 <sup>3</sup>
final weight (kg)	2908	6675	3137	5842
<b>Climate</b>				
Inside Temp. (°C)	22.9±1.1	22.5±1.0	21.7±3.9	22.1±1.7
inside humidity (%)	63.±8.	75.±5.	63.±9.	70.±7.
Outside Temp. (°C)	13.2±1.2	12.8±1.3	8.0±0.8	7.3±0.8
outside humidity (%)	71.±10.	71.±10.	85.±10.	77±10.
Mean ventilation rate (m <sup>3</sup> /h/pig)	25.4	32.7	20.0	27.3

*Table 1*  
*Global inputs and outputs of the two treatments and the two replicates*  
*(90 days, each cell containing 12 pigs).*

1. one animals died on day 50 and one on day 59.
2. Water was added in order to make possible the measurement of the slurry level.
3. The final litter of the first experiment rested almost three months within the cell without doing anything ; dry sawdust was added just before the second experiment in order to increase the C/N ratio.

The outside temperature was similar for the two cells and kept roughly constant during each replicate. It was 4 to 5 K colder during the second replicate than during the first. The cell temperatures were similar for the two replicates and the two treatments. The air humidity was higher in the litter treatment than in the slatted-floor treatment for both replicates. The air humidity in the litter treatment was slightly lower during the second replicate compared to the first replicate, as a consequence of the lower specific humidity of the fresh air (approximately 1 g water/kg dry air lower).

Table 2 gives the concentrations in water, nitrogen, and phosphorus for the inputs and outputs of each treatment and both replicates. The nitrogen and phosphorus concentrations of the litter increased during both replicates. The phosphorus concentration increased more than the nitrogen one. The increase in phosphorus concentration as compared to the nitrogen one was higher in the litter system for both replicates.

	H <sub>2</sub> O (g/kg moist weight)	Nitrogen (NTK+NO <sub>3</sub> ) (g/kg moist weight)	Phosphorus (P <sub>2</sub> O <sub>5</sub> ) (g/kg moist weight)	C/N ratio
Food <sup>4</sup>	135.5	26.69	12.1	14.7
slurry (exp I)	840.0	10.05	5.91	5.2
slurry (exp II)	855.0	8.03	6.10	6.8
initial litter (exp I)	659.5	4.56	5.32	32.3
initial litter (exp II) <sup>5</sup>	537.5	6.26	9.97	31.3
final litter (exp I)	683.0	5.99	7.80	20.5
final litter (exp II)	541.0	8.07	11.87	20.2

*Table 2*  
*Mean concentrations in water, nitrogen and phosphorus*  
*of the inputs and outputs of the two treatments and the two replicates.*

<sup>4</sup> mean values

<sup>5</sup> final litter of exp I + wood shavings at 85% dry matter.

The gas emissions of water, ammonia and nitrous oxide are given in Table 3. The emission of the three gases were similar for the slatted-floor system between the two replicates. They were also similar for the nitrogen gas and the water for the litter system. The water emission as well as the ammonia and nitrous oxide emissions were quite different between the two treatments and for both replicates.

gas emissions (per pig in 90 days)	H <sub>2</sub> O (water vapor in kg)	NH <sub>3</sub> (ammonia, in g N)	N <sub>2</sub> O (nitrous oxide, in g N)
slatted-floor (exp I)	282	575	58
slatted-floor (exp II)	281	425	33
deep-litter (exp I)	483	267	308
deep-litter (exp II)	473	275	233

*Table 3*  
*Total gas emissions of the two treatments and the two replicates*  
*(mass/fattening pig for the 90 days period).*

## **4. Conclusion**

**4.1.** We showed experimentally that continuous composting is possible in deep-litter systems during the growing-finishing phase of pigs and with a cool climate. Such composting reduces the nitrogen content of the waste and limits both ammonia and nitrous oxide emissions. As concluded by Chan et al (1994), the achievement of this objective in any farm requires an adaptation of the building and the management practices to the climate, the animal density, and the heat production of the chosen litter.

**4.2.** A rigorous comparison of the deep-litter system and the slatted-floor system, with the same building, animals and external climate showed that the final mass of organic wastes in deep-litter systems is much less than the mass excreted. This is due mostly to the evaporation of the water excreted but also to the loss of volatile elements (C, H, O, and N). The non-volatile elements (e.g. phosphorus) are concentrated by the composting process.

**4.3.** The comparison of the nitrogen gas emissions confirmed that ammonia emission is less than in slatted floor system with accumulated slurry. We confirmed that the deep-litter systems produces more nitrous oxide ( $N_2O$ ) than slatted-floor systems (Groenestein & Faassen, 1996). When used in an environmental impact assessment, e.g. in Life-Cycle-Analysis, this information should be completed by the gas emissions at other production stages and by the impacts of the systems on water and soils. The comparison of the nitrogen gas emissions to the nitrogen mass balance suggested that the major part of the nitrogen can be lost as dinitrogen ( $N_2$ ) in deep-litter systems correctly managed.

## **5. Acknowledgements**

This study was financially supported by the regional Comité Bretagne Eau Pure (Conseil Régional de Bretagne, Agence de l'Eau Loire-Bretagne, Conseil Général du Morbihan). We also acknowledge Pierre Perrin for his technical support, M. Le His and Guyomarc'h S.A. who provided the litter and the food.

## 6. References

**Bonazzi G, Navarotto PL**, (1992) Wood shaving litter for growing-finishing pigs. In: *Workshop on Deep-Litter System for Pig Farming.*, edited by J. A. M. Voermans. Research Institute for Pig Husbandry. Rosmalen. The Netherlands, 57-76.

**Chan D.K.O., Chaw D., Lo C.Y.Y.** (1994) Management of the sawdust litter in the « pig-on-litter » system of pig waste treatment. *Resources, Conservation and Recycling*, 11, 51-72.

**Groenestein C.M., Faassen van H.G.** (1996) Volatilization of ammonia, nitrous oxide and nitric oxide in deep-litter systems for fattening pigs. *Journal of Agricultural Engineering Research*, 65, 269-274.

**Klooster van't C E, Greutink G J** (1992) Water evaporation in deep litter pig houses. In: *Workshop on Deep-Litter System for Pig Farming.*, edited by J. A. M. Voermans. Research Institute for Pig Husbandry. Rosmalen. The Netherlands, 124-134.

**Lesguillier F., Gouin R., Guiziou F., Orain B.** (1995) Contribution au dossier environnemental par l'évaluation des rejets. Bilans des éléments azoté et minéraux des litières. *Journées de la recherche porcine en France*, 27, 343-350.

**Oliveira P.A., Robin P., Kermarrec C., Souloumiac D., Dourmad J.Y.** (1998) Comparaison de l'évaporation d'eau en élevage de porcs sur litière de sciure ou sur caillebotis intégral. *Journées de la recherche porcine en France*, 30, 355-361.

**Souloumiac D** (1995) Etude des microclimats réalisables dans des enceintes energetiquement autonomes soumises a des flux de chaleur d'origine metabolique. *Thèse I.N.A. Paris-Grignon*, janvier 1995, 170p.





## **A farmer-operated system for recycling food waste and municipal sludge to agriculture**

*Un système gérable à la ferme pour le recyclage de déchets agro-alimentaires  
et de boues d'épuration en agriculture.*

**Odd Jarle Skjelhaugen**

Agricultural University of Norway, Dep. of Agricultural Engineering,  
Box 5065, N-1432 Ås, Norway

E-mail : o.j.skjelhaugen@nlh10.nlh.no

### **Abstract**

*To increase the recycling rate of food wastes and domestic septic tank sludge to agriculture, a small-scale system, independent of sewer pipelines and sewage treatment plants, has been developed. The wastes are handled as liquid in a closed system. Food waste and septic sludge are stored in tanks at the homes for a period of one to two years. After being collected, the material is sanitised and stabilised in a thermophilic aerobic reactor. The pathogens are effectively reduced. The treated material is stored until spreading on suitable farm land during the growing season. The processing plant can be located on the farm and can be operated by the farmer who can, therefore, generate an extra income.*

### **Résumé**

Afin d'augmenter le recyclage agricole de déchets agro-alimentaires et municipaux (boues), un système à petite échelle indépendant du système de collecte des eaux usées a été développé. Les déchets sont gérés sous forme liquide dans un dispositif fermé. Les déchets agro-alimentaires et les boues sont stockés dans des cuves au domicile pour une durée de un à deux ans. Après la collecte, le produit est hygiénisé et stabilisé en réacteur aérobie thermophile. Les pathogènes sont effectivement réduits. Le produit traité est stocké jusqu'à son épandage lors de la saison de culture. Le système de traitement peut être installé à la ferme et géré par l'agriculteur ce qui lui procure un revenu supplémentaire.

## **1. Introduction**

Deposition of organic wastes in landfills is now forbidden in several European countries. Governments prefer most of the sewage sludge and the organic waste to be recycled to agriculture. This means that the farmers will play an important role in meeting these challenges.

Up to now, the farmers' role in recycling systems has been of a passive character, just receiving, without charge, a waste product from a treatment plant. However, this article presents a solution that might be more attractive, also taking the cash-flow into account. It is a small-scale system, independent of sewer pipelines and sewage treatment plants. The basic idea is to make the farmer an active operator who earns a real income from the environmental business. The operational responsibility is given to that party who has the greatest interest in creating sufficient control routines to ensure the waste quality, that is, the farmer himself.

The solution requires farmland suitable for spreading the processed organic wastes. In high livestock density regions with farmland already heavy loaded with manure, it would be a problem to further increase the nutrient supply. By making the waste business economic attractive, some farmers can replace livestock production with a recycling business.

## **2. The recycling system**

The wastes are handled and treated as liquid in a completely closed system, as shown in figure 1. Food waste and septic sludge is stored in tanks close to the dwellings for one to two years. After collection, the material is sanitised and stabilised in a thermophilic aerobic reactor at a temperature of 55-60 °C. The pathogens are effectively reduced. The treated material is stored until spreading on farmland during the growing season. The processing plant can be located on the farm and can be operated by the farmer who can, therefore, generate an extra income.

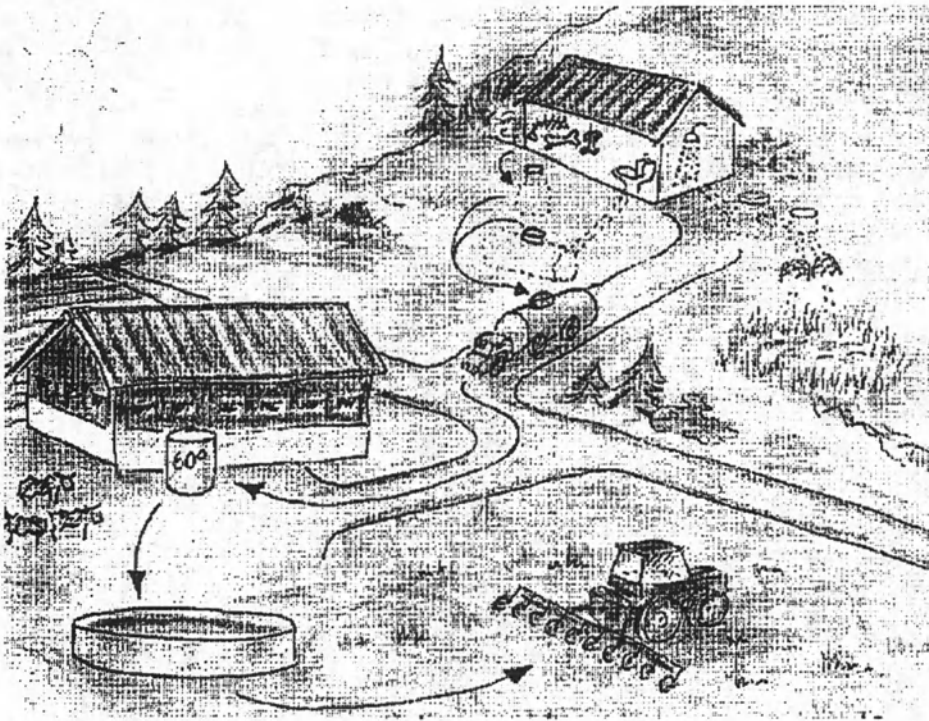

*Figure 1.*

*A farmer-operated system for recycling food waste and septic tank sludge to agriculture. The wastes are handled as liquid. They are transported from the dwellings to a processing plant located at the farm and applied to farm land during growing season.*

### **Food waste**

The food waste has to be sorted in the homes. In Norway, the food waste from private households is not used as feed for pigs, due to its low nutrient value and risk of health problems caused by fungal toxins. Instead, it is considered as a source of plant nutrients and a soil improver. Commonly, the food waste is handled as solids by collecting it in a bag in the kitchen, carrying the bag to a bin outside, and waiting for the refuse collection truck to pick up the bags once a week during summer, and once every second week during winter. (Figure 2). The frequent collection of small amounts of waste is necessary due to odour problems.

To improve the logistics and user acceptance, whilst reducing transportation costs and loss of nutrients, a liquid route is now being developed in a collaborative project between the Agricultural University of Norway and Vera Miljø Ltd. By storing food waste in a closed, sub-surface tank, the biomass produces acids that decrease pH to below 5, thereby conserving the waste. (Figure 2). Very little

degradation takes place, and gases such as hydrogen sulphide and methane are not produced. A one-year trial demonstrated that there were no problems with freezing, odour, flies, and other vectors. The biomass was emptied by a tanker (Sæther, 1996).

Since the food waste is stored at the source for a long period (one to two years), source control—analysing the tank content before emptying—might be introduced without causing a high annual cost. If the stored waste is contaminated, it must be handled via the “hazardous waste route” at a much higher cost to the householder than with the “agriculture route”.

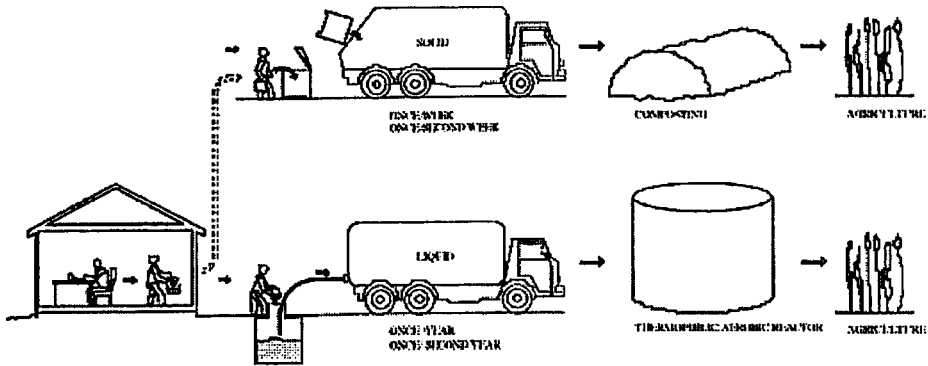

Figure 2.

*Food wastes—solid or liquid? The liquid route improves the logistics, reduces transportation cost, reduces loss of nutrients, and improves user acceptance.*

### Sanitation and stabilisation in a thermophilic aerobic reactor

The Norwegian regulations require municipal sludge to be sanitised and stabilised before spreading onto farmland. This treatment can be undertaken in a thermophilic aerobic reactor. Such a reactor has been developed in a collaborative project between the Agricultural University of Norway and Alfa Laval Agri Ltd. (Skjelhaugen, 1998). The operating parameters are: semi-continuous treatment of liquid with TS from 2 to 10%, hydraulic retention time of 7 d and processing temperature of 55 to 60 °C. In its commercial form the reactor has been made in two sizes, with capacities of 2.5 and 4.5 m<sup>3</sup>/d, respectively. No ammonia or odour is released from this one-stage, fully insulated reactor, and no energy is added for heating the biomass. The reactor is especially suitable for small and localised plants, and is often operated by farmers. (Figure 3).



Figure 3.

*A commercial plant in Meldal community for processing septic tank sludge and source separated food waste before applying it to farmland. It consists of a covered pre-storage tank, a thermophilic aerobic reactor, and a post-storage tank. The plant is located on a farm.*

### **Application to agricultural land**

A slurry application technology, developed by the Agricultural University of Norway and Moi Ltd., injects liquid wastes directly into the ground. By creating a pressure of five to eight bars and shooting small volumes of liquid into the ground, the injector ensures that the material is not exposed to air. Instead, it is placed directly into the plant root zone in the soil. Hence, low amounts of ammonia are released into the atmosphere (Morken and Sakshaug, 1996). The spreader can be connected to a flexible rubber pipe for direct transport of the liquid from the storage tank, if it is located near the farm land. This gives high spreading capacity, and low soil compaction.

### **3. The economy**

The economy for a local farmer-operated system is given in table 1. Labour needed for operation and spreading is about 400 h/year, or one day a week. The gate fees for the waste to be processed are critical for the economic balance. Fees less than NOK 150/m<sup>3</sup> sludge make a negative profit, but the profit rises very quickly as the fees increase. The fertiliser value of the processed biomass contributes to the profit, but is less important than the fees. The most profitable option is based on source separation of both household wastewater and food waste, see tables 1 and

2. Such solutions might become more common in the future, as they are especially profitable with respect to environmental aspects (Refsgaard 1997).

<i>Investments</i>				
Covered pre-storage 200 m <sup>3</sup>	180			
Thermophilic aerobic reactor with a capacity of 4.5 m <sup>3</sup> /d	540			
Post-storage 1500 m <sup>3</sup> (one year storage capacity)	280			
Pump, strainer, sieve, instruments, etc.	200			
Spreading equipment	100			1,300
<i>Annual costs</i>				
Depreciation 20 years	65			
Interest 6%	39			
Maintenance and service	30			
Energy consumption 35 kWh/m <sup>3</sup> biomass, NOK 0.5/kWh	26			
Analyses	15			175
<i>Annual income (gate fee examples)</i>				
	<i>Gate fee</i>	<i>Option 1</i>	<i>Option 2</i>	<i>Option 3</i>
Income from sludge and blackwater	0.2/ton	300	274	273
Income from food waste	0.4/ton	0	50	55
Fertiliser value	0.007/kg N	11	15	53
Income		311	339	381
Salary for operation and spreading (income - cost 175)		136	164	206

*Table 1.*

*The economic balance for a farm operated recycling system for household wastewater sludge, source separated blackwater and source separated food waste, based on treatment in an thermophilic aerobic reactor, NOK 1000. Options 1, 2, and 3 refer to table 2.*

In addition to processing and spreading, the farmer can transport the waste materials from the dwellings to his farm. Typically the annually income for such a service is about NOK 200,000, based on an emptying fee of NOK 300 to 500 per dwelling. With an investment of about NOK 250,000 and annual capital and running costs of about NOK 50,000, the payment for labour is NOK 150,000. About half a man year is needed per year.

#### **4. Contamination risks**

Inorganic contaminants such as heavy metals are not removed in the aerobic process. Therefore they must be kept outside the recycling system. However, several analyses indicate that normal food waste, blackwater, and septic tank sludge contain low concentrations. As shown in table 3, the contents in food waste and blackwater was below the strict limit values for class I waste (Ministry of Environment 1996), which can be applied in amounts up to 4000 kg TS/ha. Septic tank sludge was acceptable for application rate of 2000 kg TS/ha (class II). It is important that the recycling system includes a means of source control, to ensure the quality of the waste to be used for new food production. Contaminated material has to be excluded from the agriculture route.

Waste source	Processing plant	Application to agricultural land
<i>Option 1. Recycling septic tank sludge from tanks with overflow</i>		
<p>From <b>750 dwellings</b>  - with septic tanks of 4 m<sup>3</sup> which are emptied every second year without dewatering the sludge. The overflow from the tank, and thereby some N and K, flows to the ground.</p>	<p>Capacity per year: <b>1500 m<sup>3</sup> septic sludge</b>  Septic sludge with 1.7% TS (Sæther 96) and nutrient content, % of TS: N 6.2; P 1.4; K 2.6 and nutrient content, kg/m<sup>3</sup>: N 1.1; P 0.2; K 0.4  TS is near the lower limit for successful processing. A small supply of other organic wastes is recommended.</p>	<p>To be incorporated into the soil on land for growing cereals or grass, to be included in fertilising plans. Norwegian sludge regulations allow up to 2000 kg TS/ ha year, i.e., <b>12.8 ha</b> spreading area.  Application rate per ha: 117 tonnes sludge, 128 kg total-N, 23 kg P and 47 kg K.</p>
<i>Option 2. Recycling septic tank sludge from tanks with overflow and source separated food waste</i>		
<p>From <b>685 dwellings</b>  - with septic tanks of 4 m<sup>3</sup> which are emptied every second year without dewatering the sludge. The overflow from the tank, and thereby some N and K, flows to the ground.  - with source separation of food waste. 70 kg/person year, 2.5 person/dwelling and volume weight 0.95 makes 0.18 m<sup>3</sup> waste/dwelling year</p>	<p>Capacity per year: <b>1370 m<sup>3</sup> septic sludge</b>  <b>126 m<sup>3</sup> food waste</b>  Septic sludge with 1.7% TS (Sæther 96) and nutrient content, % of TS: N 6.2; P 1.4; K 2.6  Food waste with 28% TS (Norin 1996) and nutrient content, % of TS: N 2.1; P 0.5; K 1.1  Mixture with 3.9% TS and nutrient content, kg/m<sup>3</sup>: N 1.4; P 0.3; K 0.7</p>	<p>To be incorporated into the soil on land for growing cereals or grass, to be included in fertilising plans.  Spreading based on 2000 kg TS/ha year.  Farmland for application: <b>29.3 ha</b>.  Application rate per ha: 51 tonnes sludge and food waste, 71 kg total-N, 15 kg P and 35 kg K.</p>
<i>Option 3. Recycling source separated blackwater from closed tanks and source separated food waste. Observe.: new toilet with very low water consumption.</i>		
<p>From <b>757 dwellings</b>  - with source separation of wastewater. Blackwater is stored in closed tanks and emptied yearly. No nutrients are lost to the ground. 0.73 m<sup>3</sup>/person year, 2.5 person/ dwelling makes 1.8 m<sup>3</sup>/dwelling year (Sæther 1997)  - with source separation of food waste. 70 kg/person year, 2.5 person/dwelling and volume weight 0.95 makes 0.18 m<sup>3</sup> waste/dwelling year.</p>	<p>Capacity per year: <b>1363 m<sup>3</sup> blackwater</b>  <b>137 m<sup>3</sup> food waste</b>  Blackwater with 3.4% TS (Sæther 1997, use new toilet) and nutrient content, % of TS: N 14.4; P 2.1; K 1.9  Food waste with 28% TS (Norin 1996) and nutrient content, % of TS: N 2.1; P 0.5; K 1.1  Mixture with 5.6% TS and nutrient content, kg/m<sup>3</sup>: N 5.0; P 0.8; K 0.9</p>	<p>To be incorporated into the soil on land for growing cereals or grass, to be included in fertilising plans.  Spreading based on 2000 kg TS/ha year.  Farmland for application: <b>42.3 ha</b>.  Application rate per ha: 35 tonnes sludge and food waste, 177 kg total-N, 28 kg P and 32 kg K.</p>

**Table 2.**

*Key-data for a farmer-operated recycling system based on processing 4.5 m<sup>3</sup>/d in a thermophilic aerobic reactor. Three options with different combinations of domestic wastewater sludge and food waste are given. They represent a step-by-step implementation of the system.*

Metal		Limit values *)		Food waste		Septic tank sludge	Balckwater	
		cl.I	cl.II	1)	2)	1)	3)	2)
Copper	Cu	150	650	13	48	367	101	42
Zinc	Zn	400	800	24	141	611	351	260
Cadmium	Cd	0.8	2	0.1	0.3	1.4	0.6	0.2
Mercury	Hg	0.6	3	0.1.	0.1	2.7	<0.8	0.4
Nickel	Ni	30	50	2.2	10	32	4.6	2.4
Lead	Pb	60	80	10.6	26	25	7.2	5.2
Chrome	Cr	60	100	2.6	53	13	5	2.6

\*) Ministry of Environment 1996, class I allows application of 4000 kg TS/ha, class II 2000 kg TS/ha  
1) Sæther 1996 (Norway); 2) Norin 1996 (Sweden); 3) Sæther 1997 (Norway)

*Table 3.*

*Content of heavy metals in source separated food waste, septic tank sludge, and source separated blackwater from private households, mg/kg TS.*

## 5. Conclusion

*The results so far can be summarised as :*

- *The wastes are converted to a hygienic and stable liquid product.*
- *No nutrients, including ammonia, are lost on their way from households to farm land.*
- *Odour is not a problem.*
- *The product is well suited as organic fertiliser for cereal production.*
- *Source control is possible at the level of the individual house.*
- *Quality control of the reused materials is made by the farmer himself.*
- *The farmers labour payment for treatment and spreading is NOK 100,000 - 200,000 a year, from about 750 dwellings. In addition, similar payment can be generated from transport service.*
- *The recycling business can replace livestock production, and thereby reduce the nutrient supply to farmland without reducing the farmers' income.*

## 6. References

**Ministry of environment** Forskrift om avløpsslam. (Sewage sludge regulation). ISBN 82-457-0117-3. Oslo, 1996

**Morken, J.; Sakshaug, S.** Direct Ground Injection (DGI®) - a new concept of slurry injection. AgEng Paper 96E-005, 1996



**Norin, E.** Våkompostering som stabiliserings och hygieniseringsmetod för organiskt avfall. (Liquid composting for the stabilisation and hygienisation of organic waste.) JTI-report Kretslopp & avfall no 3, Swedish Institute of Agricultural Engineering, Uppsala, 1996

**Refsgaard, K.** Resirkulering, økonomi og miljø for handtering av avløp og organisk avfall. (Recycling, economy and environment by handling wastewater and organic wastes.) Proceedings. Conference Rural Development, Hamar, Norway, 1997

**Skjelhaugen, O. J.** Thermophilic aerobic reactor for processing liquid organic waste. Submitted to Water Research, 1998

**Sæther, T.** Behandling av matavfall og avløpsslam i våt form . (Treatment of food waste and sewage sludge in wet form.) Print no 24-96. Dept. of Agricultural Engineering, Agricultural University of Norway, 1996

**Sæther, T.** Gravitasjons- eller vakuomtømming av Waterless-toalettet. (Emptying the Waterless toilet by gravity or vacuum.) Confidential report no 100-1997. Dept. of Agricultural Engineering, Agricultural University of Norway, 1997.



# **A management perspective on improved precision manure and slurry application**

*Une perspective de gestion pour améliorer la précision de l'épandage de lisiers et fumiers.*

**K A Smith \* and D J Baldwin**

ADAS Wolverhampton, Woodthorne, Wolverhampton, WV6 8TQ, UK

E-mail : Ken\_Smith@adas.co.uk.

## **Abstract**

*Surface application of manures and slurries is still, by far, the most common approach used on UK farms for the spreading of farmyard manure (FYM), poultry manure (PM) and slurries. On-farm evaluation of spreading machinery performance has been undertaken, including a total of 41 separate machines, covering the four main machine categories currently in operation and three manure types :*

- *side discharge, rotary spreaders (FYM)*
- *vacuum tankers (slurry)*
- *side discharge, dual-purpose spreaders (FYM, PM, slurry)*
- *flat-bed, rear discharge spreaders (FYM, PM).*

*Whilst substantial variability in machine performance (both in terms of application rate and spreading pattern) was observed, data on lateral coefficient of variation(CV) and spreading bout width indicated that considerable improvements in performance could be achieved by simple adjustment of bout spacing.*

*Keywords* : *organic manures, land application, precision, management*

## **Résumé**

L'épandage en surface des fumiers et lisiers est à ce jour la pratique la plus courante au Royaume-Uni. Des essais à la ferme en utilisant le matériel d'épandage ont été réalisés, soit un total de 41 équipements testés couvrant les 4 catégories suivantes :

- *épandeur latéral rotatif (fumiers)*
- *tonnes sous vide (lisiers)*
- *épandeur latéral*

Bien qu'une grande variabilité dans les performances des équipements testés ait été observée, des améliorations considérables peuvent être obtenues avec de simples ajustements.

*Mots-clés* : *déjections, épandage, précision, gestion.*

## 1. Introduction

In arable, mixed farming, and predominantly grassland areas of the UK, it is common practice to apply livestock manures, including slurries and solid manures, to land during the autumn and early winter period. Manure stores and slurry tanks are often emptied prior to the winter when the accessibility of arable stubbles and trafficability of land make this the ideal time for spreading operations. The perceived usefulness of manure nitrogen (N) is low, because of the losses anticipated over the winter months; also, because the focus is not on the utilisation of manure nutrients, little attention is paid to way in which spreading operations are carried out.

Poor (uneven) manure applications may cause problems due to nutrient excess (e.g. crop lodging in cereals, excessive top growth in root crops and poor quality), or nutrient shortage and possible yield reduction. In a recent study of manure management practice on farms in England and Wales, a high proportion of farmers (>75% with poultry manure, >60% with pig manure) agreed that if they could apply manures more evenly, they would consider spring application and further savings on fertiliser inputs (Parham, 1997). Moreover, as guidelines on the utilisation of manures improve (e.g. Steffens and Lorenz, 1997; Chambers *et al*, 1996) and farmers attempt to reduce fertiliser inputs, the accuracy and reliability of manure spreading increases in importance.

The studies described in this paper have focused on the range of manure spreader performance achieved on commercial farms, the importance of accurate spreading for grass silage production and on some preliminary strategies for improved spreading practice.

## 2. Approaches

### On-farm manure spreader tests

On-farm tests were carried out on a range of machinery, working under normal operating conditions, i.e. with no attempt to influence the operator. The principal performance criteria assessed during this study were as follows :

(1) *Bout matching* (to determine overlapping of adjacent runs) - the distance between a reference marker, such as a nominated wheel, was recorded manually, at a minimum of seven points spaced at 25 metre intervals along the line of travel, on adjacent runs.

(2) *Forward speed* - assessed by the accurate measure of time taken for travel between markers at 25 metre intervals.

(3) *Lateral uniformity* - methodology was based on spreader evaluation procedures proposed by the European Committee for Standardisation (CEN, 1996), using

plastic trays 0.5m x 0.5m and 100mm deep, laid in a line perpendicular to the direction of machine travel and to at least 8m to either side of the centre line. For spreader types discharging to one side only, collection trays were laid out accordingly. From the recorded tray weights, lapped and unlapped spreading patterns, and associated Coefficient of Variation (CoV) were computed.

(4) *Discharge rate over run duration* was assessed by static test, with weight of the machine recorded at 6 second intervals during discharge from fully laden. In this paper only results of bout width and lateral spread uniformity are presented.

### **Agronomic effects of spread pattern on grass for silage**

Replicated grassland plot experiments, to evaluate the agronomic effects of slurry distribution pattern, were undertaken before first or second silage cuts over two years. Cattle slurry was applied to strips 1.5m wide and 5m length, using a plot applicator (Basford et al, 1996), at varying rates over 7 such strips making up a full plot size of 10.5m x 5m. Application rates, over the full plot, were set at 40m<sup>3</sup>/ha but were achieved with varying levels of lateral uniformity (0%, 17%, 32% and 41% CoV), according to distribution patterns typical of those observed in the on-farm tests. The effects of the slurry N, at the rate applied (approx. 80 kg/ha total N, 39 - 46 kg/ha NH<sub>4</sub>-N ) and an extra 40 kg/ha fertiliser N were compared with grass N response, based on 6 levels of N (0-180 kg/ha).

### **Improved spreader performance testing**

Further tests on a limited number of machine types and focusing on specific factors likely to affect performance, including manure type and consistency, machine settings, slurry splash plate design and setting, have also been undertaken but are not reported here.

## **3. Results and discussion**

### **On-farm manure spreader tests**

A total of 41 separate machines have been tested, covering four main categories:-

- side discharge, rotary spreaders (FYM)
- vacuum tankers (slurry)
- side discharge, dual-purpose spreaders (FYM, PM, slurry)
- flat-bed, rear discharge spreaders (FYM, PM)

Together, these machines are representative of the great majority of spreading equipment currently in use within UK farming. Application rates were highly variable between farms and spreaders, and from the spreaders themselves, even where machine make and type was similar, and also over the run duration of a single machine. One disappointing feature of the study was that, in many cases, it

was apparent that farmers had little knowledge of the nutrient content of the manure being spread or of the capacity of the spreader and, therefore, application rate.

Lateral CoV, measured at the average bout width for each machine, could be greatly reduced, simply by adjusting bout width according to computer simulation to estimate the optimised, lapped spread; the results of this procedure are summarised initially in figure 1(a) for slurry tankers and (b) across the 3 types of solids spreaders. In all cases, lateral CoV could be reduced to less than 30%, with the majority below 20%, as a result of initial testing and optimum setting of spreader bout width. Adjustment for optimum spread pattern, in general, required a reduction in bout width (see Table 1), though for individual machines, especially slurry tankers, this was not always the case. On grassland, such adjustments to spreader bout width would cause no difficulty, in contrast to manure top dressing of arable crops where tramline systems of up to 24m would render such adjustments almost impossible, except for the adoption of new technology, low trajectory slurry applicators of the type now in common use in the Netherlands, Germany and Denmark.

(a) Slurry vacuum tankers (13 observations)

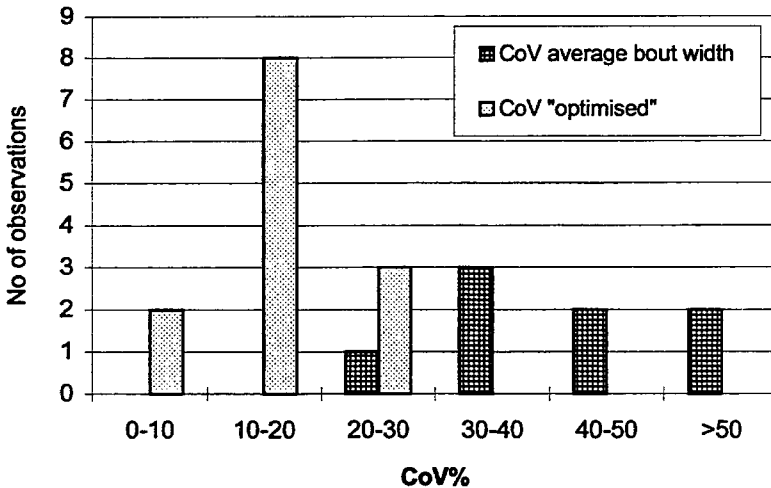

(b) Solids spreaders (26 observations)

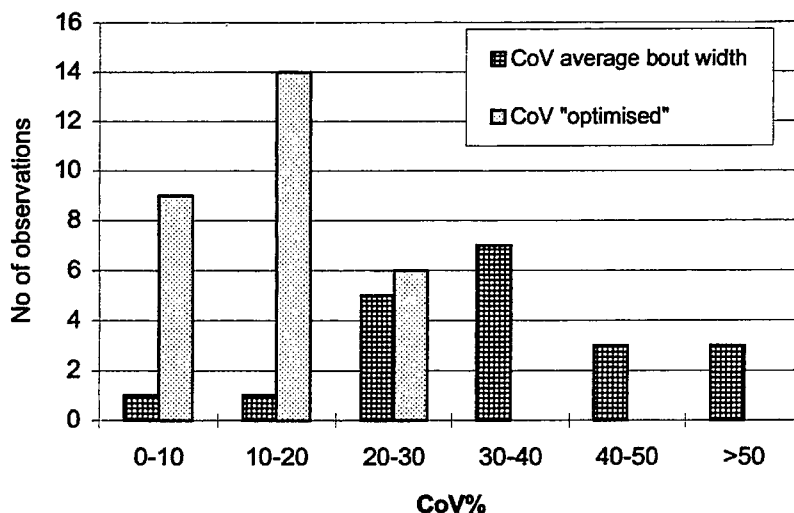

Figure 1.

Frequency distribution of lateral CVs measured at average bout width compared to calculated CV at optimum bout width

Machine Type	No of Observations	Recorded Performance		'Optimised' Performance	
		Av. bout width (m)	Ave CoV%	Opt bout width (m)	Opt CoV%
Rotary	9	3.5	39	2.3	15
Slurry tanker	14	8.9	37	9.1	15
Rear-discharge	6	4.4	22	3.5	11
Dual-purpose	12	6.0	35	4.3	20

Table 1.

Average observed machine bout width and CoV and comparison with simulated optimum bout width and CoV.

### Agronomic effects of spread pattern on grass for silage

Despite a clear response to fertiliser N, up to 70-80 kg/ha N in the second cut in 1996 and, up to 100-120 kg/ha N, first cut 1997, there were no significant differences between spread patterns, either in terms of dry matter (DM) yield or N offtake. However, significant increases in yield ( $p < 0.05$ ) and N offtake ( $p < 0.01$ ) were recorded from the extra 40 kg/ha N fertiliser, in both years, confirming the responsiveness of the site to N and the sensitivity of the experiment to potential yield loss and changes in grass N offtake, as a result of slurry spreading pattern (Table 2).

	Supplementary fertiliser N	Slurry distribution pattern CoV				p	SED
		0%	17%	32%	41%		
2nd cut 1996	-	4.50	4.42	4.66	4.51	0.65	n.s.
DM yield t/ha	40 kg/ha	4.90	4.99	5.22	5.01	0.05	0.11
N offtake kg/ha	-	60.7	62.8	63.4	64.8	0.75	n.s.
	40 kg/ha	81.5	73.5	78.8	75.3	<0.01	0.96
1st cut 1997	-	5.88	6.20	6.40	5.85	0.39	n.s.
DM yield t/ha	40 kg/ha	6.97	7.00	6.85	6.94	<0.05	0.15
N offtake kg/ha	-	73.3	71.2	74.0	64.1	0.21	n.s.
	40 kg/ha	82.8	89.6	91.8	84.8	<0.01	0.96

Table 2.

*Effect of slurry distribution precision, with and without fertiliser N top dressing, on grass DM yield and N offtake (1996-1997).*

This result is not surprising, given that the overall, slurry application rate supplied 39 and 46 kg/ha  $\text{NH}_4\text{-N}$ , respectively, in the experiments in 1996 and 1997, i.e. well within the linear or steep part of the N response curve. Variation in N supply, as a result of variable slurry application, would inevitably result in localised increase or decrease in grass DM yield and N offtake, depending upon whether the slurry applied at that point was above or below target rate. Increased and decreased growth and N uptake, from areas of high and low N supply, respectively, then appear to have cancelled each other out, with a net result of no observable difference between the different spread patterns. Whilst such a result seems less likely following manure applications to arable crops sensitive to N supply, such as winter wheat or potatoes, it is quite common for N to be applied to grassland at sub-optimal levels and for dilute cattle slurry, with moderate N content, to be applied at rates of around 40 m<sup>3</sup>/ha; Chambers *et al.*, (1996) reported average N use on grass for silage, in England and Wales, 1992-1994, at 170 - 180 kg/ha, whereas the recommended rate for a two-cut system would vary 220 - 270 kg/ha, depending upon cutting date and residual soil N fertility (MAFF, 1994). Therefore, the results reported may be representative of many situations where manures are applied within grassland systems. In such situations, the sometimes quoted performance target of 16% CoV, as applied to the calibration of mineral fertiliser spreaders (Anon, 1984) seems unnecessarily ambitious.



## **4. Conclusions**

**4.1.** On-farm assessments of manure spreading operations have confirmed that performance varies considerably between farms and, even, within a single machine type used under different conditions. In these studies, a lack of awareness was apparent, in many cases, of even some of the very basic requirements for good management of land spreading, such as the capacity of the spreader and the nutrient content of the materials being spread.

**4.2.** The lateral spread pattern CoV could be considerably reduced, by correct setting of machine bout width - typically a reduction in CoV of 50% or more was possible in this way, in most of the machines tested. Rear-discharge solids spreaders and slurry tankers with splashplates offer a symmetrical discharge pattern which facilitates successful bout matching and an overall low lateral CoV.

**4.3.** From agronomic assessments on the effect of manure and slurry spread pattern suggest that, where slurry or manure and fertilisers supply N at sub-optimal levels on grassland, application precision is not of critical importance. Taken together with the machinery tests, this work suggests that the currently available equipment, correctly set up and carefully managed, is capable of achieving very satisfactory results on many farms.

## **5. Acknowledgement**

Funding of this work by the UK Ministry of Agriculture Fisheries and Food (MAFF) is gratefully acknowledged.

## **6. References**

**Anon.** (1984) Fertiliser handling and application. ADAS Mechanisation Booklet 15. MAFF Booklet 2115.

**Basford, W.D., Briggs, W., Jackson, D.R. and Smith, K.A.** (1996). Equipment for the improved precision application of animal waste slurries and liquid effluents to field plots. Proceedings of the International Conference on Mechanisation of Field Experiments (IAMFE '96), Versailles, France, June 1996 pp 161-166.

**CEN** (1996) European Committee for Standardisation. Manure spreaders - specification for environmental safety - requirements and test methods. CEN/TC 144/WG3/AH3. March 1996. Union de Normalisation de la Mécanique, F92400 Courbevoie, Paris la Defense.

**Chambers, B J, Mitchell, R. D., Garwood, T. and Webb, J.D. (1996)** Fertiliser use (NPK) on tillage crops and grassland, in England and Wales 1969 - 1994. MAFF Contract Report CSA 2845, 16pp.

**MAFF (1994)** Fertiliser recommendations for agricultural and horticultural crops. Reference Book 209, HMSO, London.

**Parham, C. (1997)** Survey of animal manure practices in the pig industry. Report to MAFF RMED, July 1997, ADAS Market Research.

**Steffens, G. and Lorenz, F. (1997)** Good agricultural practice in the application of organic manures. In "Agronomically useful and environmentally careful organic manuring on arable land and on grassland". Final report on the Concerted Action. CEC, Contract No AIR 3 - CT 920336.

# Management of pig slurry for nitrogen fertilization of corn

*Gestion du lisier de porc pour une fertilisation azotée du maïs*

**Y. Fauvel, T. Morvan**

Unité d'Agronomie, INRA, 65, rue de Saint-Brieuc. F-35042 Rennes. France

E-mail : [fauvel@rennes.inra.fr](mailto:fauvel@rennes.inra.fr) ; [morvan@rennes.inra.fr](mailto:morvan@rennes.inra.fr)

## Abstract

*A five-year lysimeter experiment was carried on a one meter deep loamy soil, pH 6,1 , to test the effect of pig slurry management on crop production and water quality. The optimum nitrogen fertilizer rate ( $X_{min}$ ) was calculated annually using the balance sheet method ;  $X_{min}$  varied from 60 to 124 kg N ha<sup>-1</sup>. Pig slurry was annually applied i) in late spring, at three rates,;:  $X_{slu}$ ,  $X_{slu} + 75$ ,  $X_{slu} + 150$  kg N ha<sup>-1</sup>, and ii) in mid autumn ( $S_{DCD}$ ), at the rate of 3 l m<sup>-2</sup> (corresponding to 180-200 kg N ha<sup>-1</sup>), mixed with a denitrification inhibitor (DCD, 25 l ha<sup>-1</sup>). The slurry was manually incorporated , immediately after spreading. This five-year experiment suggests that :i) the optimum nitrogen fertilizer rate calculated according to the balance sheet method seems to strike an acceptable balance between high crop production and low level of water pollution, ii) this level of fertilization can be achieved with « repeated » and exclusive fertilization with pig slurry, iii) the two methods of slurry management (late spring or mid autumn, with DCD) gave similar results.*

Keywords : slurry, fertilization, lysimeter, leaching

## Résumé

Une expérimentation a été menée pendant cinq ans sur un dispositif lysimétrique, pour étudier les effets sur la production et la qualité de l'eau de différents modes de conduite de la fertilisation du maïs avec du lisier de porc. La dose optimale d'azote ( $X_{min}$ ) a été calculée chaque année par la méthode du bilan prévisionnel, et a varié de 60 à 124 kg N ha<sup>-1</sup>. Le lisier de porc a été apporté chaque année : i) en juin, à 3 doses :  $X_{slu}$ ,  $X_{slu} + 75$ ,  $X_{slu} + 150$  kg N ha<sup>-1</sup>, et ii) en novembre (SDCD), à la dose de 3 l m<sup>-2</sup> (correspondant à un apport d'azote de 180-200 kg N ha<sup>-1</sup>), mélangé à un inhibiteur de nitrification (DCD, 25 l ha<sup>-1</sup>). Le lisier a été incorporé immédiatement après épandage. Cette expérimentation pluri-annuelle montre que i) la méthode du bilan prévisionnel et la valeur du coefficient d'équivalence engrais du lisier s'avèrent robustes, et conduisent à un compromis correct entre l'exigence de rendements élevés et d'un niveau bas de pollution, ii) la fertilisation du maïs exclusivement par du lisier de porc donne des résultats similaires à ceux obtenus avec l'engrais minéral, iii) des résultats proches sont obtenus avec deux modes de gestion du lisier (apport de printemps, ou d'automne, avec addition de DCD).

Mots-clés : lisier, fertilisation, lysimétrie, lessivage.

## Introduction

The intensification of livestock production in Brittany over the past 30 years has led to the production of high quantities of animal waste, of which approximately 75 % are slurries (Chadwick et al, 1998). The cheapest solution for disposing of these effluents is often to spread them on cultivated soils and pasture land, as this allows recycling of the nutrients. However, environmental problems related to livestock land use are rapidly leading to increasing nitrates concentration.

Nitrate contamination of surface and groundwater due to the excessive application of animal wastes has been well established. Spallacci (1981) showed in a four-year lysimeter trial, on different soils manured with pig slurry, that nitrogen losses were influenced by soil type, slurry rates, and by the timing of slurry dressing. The N leached varied from 20 to 50 kg N ha<sup>-1</sup> at moderate rates of slurry application (200-400 kg N ha<sup>-1</sup>), but strongly increased at higher rates, rising to 250 kg N ha<sup>-1</sup> on a sandy loam soil. Carey et al (1997) in their investigation into the behaviour of <sup>15</sup>N-labelled pig slurry spread on a cut sward, pointed out that the N leached was significantly higher at an application rate of 400 kg N ha<sup>-1</sup>, compared to one of 200 kg N ha<sup>-1</sup>.

Liquid manure has a high yield effect due to its high ammonia content and the low C:N ratio of its organic fraction (Tietjen, 1981, Boschi et al, 1981), but its nitrogen efficiency is lower than that obtained with mineral nitrogen. Apparent N efficiencies, obtained by comparison with mineral nitrogen fertilization, ranged from 40 to 80 % after application of pig or cattle slurry (Duthion, 1981, Chambers and Smith, 1992, Morvan et al, 1995). The N efficiency of slurry N depends mainly on : i) slurry chemical composition, particularly the dry matter content, as indicated by Chambers and Smith (1992), ii) soil characteristics (Smit and Chambers, 1992), and iii) application techniques (Wouters, 1995). The usual operational models of manure availability to plants (Pratt et al, 1973, Sluijsmans and Kolenbrander, 1977) are very simple, and assume that the N efficiency of nitrogen manure is constant over a wide range of situations : for example, manure type is taken into account, but the variability of the composition of a given manure type is not considered. These simple models despite their imperfections are often used as operational models, but we note that the soundness of the reasoning underlying fertiliser application has been poorly studied.

A five-year lysimeter trial was carried out in order to test the accuracy of a simple operational model of manure N availability, as regards satisfying plant requirement and water quality, and two different application times were compared.

## Material and method

### Soil and lysimeter description :

The study was conducted in Brittany (France) on a loamy soil. The lysimeters were built in 1991 and five trials were carried out from 1993 to 1997. Lysimeters were of

closed type and consisted of concrete tanks (1,5 m x 1,34 m x 1.10 m deep) filled with : i) a layer of gravel placed at the base of each lysimeter to facilitate drainage, and ii) successive layers of soil, each 10 cm deep. The space surrounding the lysimeter was also filled with soil, so that the upper part of each lysimeter was at ground level. Each lysimeter was surrounded by a 150 m<sup>2</sup> experimental field area, subjected to the same technical itinerary. Leachates were collected at varying intervals according to the amounts of drainage water.

The characteristics of the upper layer of the soil were as follows: organic C : 1.04%; total N : 0.123 % ; C:N : 8.5 ; pH : 6.1 ; clay :15 % ; loam : 71 % ; sand : 14 %.

#### Climatic conditions :

Daily measurements of rainfall were obtained on site and of air temperature from a weather station located near the experimental site.

The mean rainfall during these five years was 701 mm, and was close to the average rainfall (714 mm) over 16 years ; 50 to 60% of the total rainfall occurred during autumn and winter, although the last two winters were not very wet. The summer rain fell essentially as storms (June to August) ; such events led to drainage only once, in 1993.

A severe drought in 1996 resulted in poor yields, whereas a storm in June 1997 retarded the development of the water deficit, and allowed high yields.

The mean air temperature during these five years was 11.8 °C, and was higher than the average air temperature over 16 years (10.2 °C).

#### Experimental design :

Different treatments were applied since 1993 to the 6 lysimeters and to the 150 m<sup>2</sup> area surrounding each lysimeter, cultivated with corn (DEA). Except for the control treatment, the rates of nitrogen application varied from year to year as follows :

- the mineral nitrogen rate ( $X_{\min}$ ) was calculated according to the nitrogen requirement of the crop to be grown, using the balance sheet method (Remy and Hebert , 1977, Machet et al, 1990) :

$$R_f - R_i = Mn + X_{\min} - L - bY$$

where

bY = plant population requirement (under the hypothesis that  $b = 13 \text{ kg N t}^{-1} \text{ DM}$  for corn).

$R_i$  = mineral nitrogen available at the beginning of the analysis (mid March in our case)

$R_f$  = mineral nitrogen at harvest

Mn = net mineralization of three organic pools : soil humus, crop residues and

organic manure

$X_{min}$  = mineral fertilizer rate

$L$  = Nitrogen leaching between  $R_i$  and  $R_f$  (hypothesis that  $L=0$ )

$R_i$  was measured at the end of the winter ; other parameters were estimated, so that  $X_{min}$  could be calculated . It was considered that a reasonable way of estimating  $Y$  was to take the average of the two highest DM yields during the past 5 years ; the value of  $16 \text{ t DM ha}^{-1}$  was considered, according to local references, except in 1996, because problems at emergence clearly led us to lower the objective yield. The  $X_{min}$  rate varied from 60 to  $124 \text{ kg N ha}^{-1}$  over the five years.

- the « equivalent » rate of slurry  $X_{slu}$  was calculated by assuming that 70 % of the total nitrogen of the slurry was available as mineral nitrogen ( Desvignes, 1995). But as determination of the total nitrogen content of the slurry required a laboratory chemical analysis, we preferred a more operational way of determining the nitrogen content, which consisted of: i) determining the ammonia content with a rapid method analysis (Agros or Quantofix apparatus) used by farmers, just before spreading ; this method gives accurate values of ammonia content (Bertrand, 1985), and ii) assuming that the  $N_{tot}:NH_4$  ratio is equal to 1.43. The main assumptions that were adopted in calculating the rates of mineral and slurry nitrogen are summarized in figure 1.

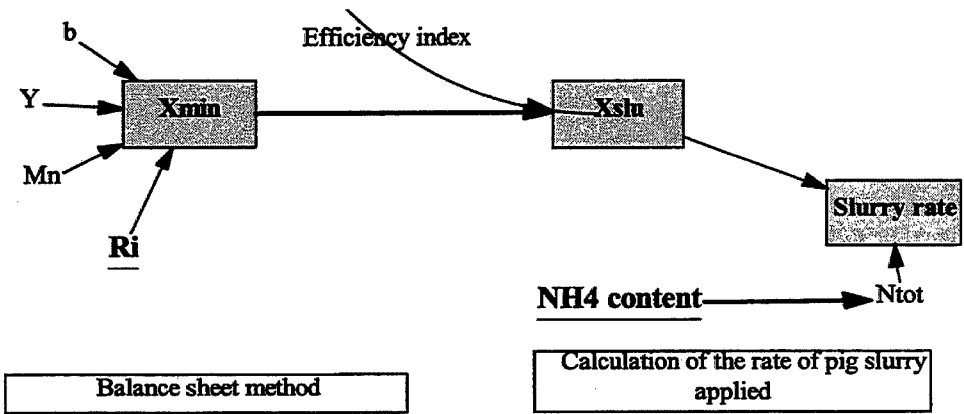

Figure 1.

Diagram representing the calculation of  $X_{min}$  and  $X_{slu}$  rates (in  $\text{kg N ha}^{-1}$ ) and slurry rate ( $\text{m}^3 \text{ ha}^{-1}$ ) (underlined parameters were measured)

- two slurry treatments were also added :  $X_{slu} + 75 \text{ kg N ha}^{-1}$  ,  $X_{slu} + 150 \text{ kg N ha}^{-1}$  ; the additional amounts of slurry were calculated on an ammoniacal nitrogen basis.

A final slurry treatment was made in autumn on bare soil at a rate of  $3 \text{ l m}^{-2}$  (corresponding to  $180\text{-}200 \text{ kg ha}^{-1}$ ). A nitrification inhibitor (DCD) was added to the slurry at a rate of  $25 \text{ l ha}^{-1}$ , because earlier studies, confirmed by the results of Morvan et al (1996) had shown that nitrification of slurry ammonium occurred too

rapidly to prevent a risk of nitrate leaching during winter, under our climatic conditions. The slurry was spread during the ten days before November 15<sup>th</sup> because slurry spreading is not allowed by law in Brittany after this date.

The slurry was incorporated manually immediately after spreading, for all treatments, to prevent ammonia losses.

Calculations :

The efficiency of use of N from slurry or mineral fertilizer was calculated from the apparent nitrogen recovery ( $ANR_{sl}$ ), which was the increase of the amount of N contained in the whole plant at harvest (obtained by difference with the control treatment), expressed as a percentage of the N applied in the slurry or fertilizer. Slurry ANR ( $ANR_{sl}$ ) may also be related to the ANR obtained with mineral nitrogen ( $ANR_{min}$ ), and can be considered as an « efficiency index » of the slurry nitrogen.

**Results and discussion**

Dry matter yields and nitrogen absorption :

Poor emergence of maize and drought stress in 1996 strongly depressed yields at all N rates. In contrast favourable climatic conditions in 1997 led to very high dry matter yields. The average of the two highest dry matter yields on  $X_{min}$  treatment was close to the 16 t DM ha<sup>-1</sup> yield objective used for the balance sheet method calculations, and confirmed that the yield objective was realistic. The dry matter yields were however highly variable, even when the 1996 yields were not considered. Corn was responsive to increasing slurry N until the rate  $X_{slu+75}$  (table 1) ; dry matter yields at  $X_{slu+75}$  and  $X_{slu+150}$  were in fact on average 2.6 and 1.6 t DM ha<sup>-1</sup> year<sup>-1</sup> higher than the yields obtained at the  $X_{min}$  and  $X_{slu}$  rates respectively. The results therefore suggest that the  $X_{min}$  rate underestimated the optimum.

	Dry matter yield (t DM ha <sup>-1</sup> )	Total N uptake (kg N ha <sup>-1</sup> )	b (kg N / t DM)	% N recovery *
Control	10.6	100	9.43	-
$X_{min}$	12.9	136	10.54	65.7
$X_{slu}$	13.9	151	10.86	52
$S_{DCC}$	14.4	153	10.62	42.6**
$X_{slu+75}$	15.4	182	11.81	39.1
$X_{slu+150}$	15.6	185	11.85	26.3

\* : mean value on years 1994,1995,1997

\*\* : mean value on years1994,1995,1996,1997.

*Table 1.*

*Mean values over five years of dry matter yield and total N (total Nuptake = 1.1 x Nuptake aerial biomass) for the 6 treatments.*

Despite the wide range of their value over the five years, dry matter yields between the  $X_{min}$  and  $X_{slu}$  treatments were similar, slightly higher amounts of nitrogen being

taken up under the  $X_{slu}$  treatment, except in 1997 when the nitrogen uptake was 22 % higher with the slurry, compared to the mineral treatment (fig 2). These results therefore conferred a soundness to the very simple method used to calculate the slurry dose under our experimental conditions, where ammonia volatilization was limited by slurry incorporation. ANR values ranged from 49 to 81 % for  $X_{min}$  treatment, and from 31 to 67 % for  $X_{slu}$  treatment.

- Despite the long residence time of the autumn spread slurry, similar yields and N uptake, were obtained between the slurry added with DCD applied in autumn and the slurry spread in spring, over all five years (fig 2). Our results are in agreement with those of Schröder et al (1993) ; these authors obtained similar dry matter yields and ANR values, when cattle slurry was applied with DCD in autumn or without DCD in spring, whereas lower yields were observed when cattle slurry was applied without DCD in the autumn. The mid autumn treatment gave higher yields in 1996, compared to  $X_{min}$  and  $X_{slu}$ , which could be explained by a better distribution of mineral nitrogen in the soil profile, during the period of active nitrogen absorption by the crop.

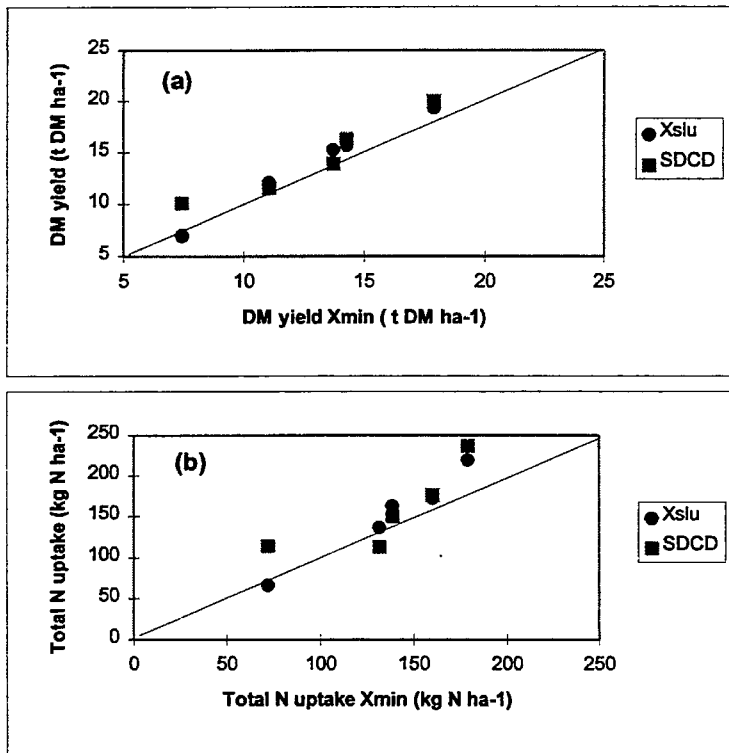
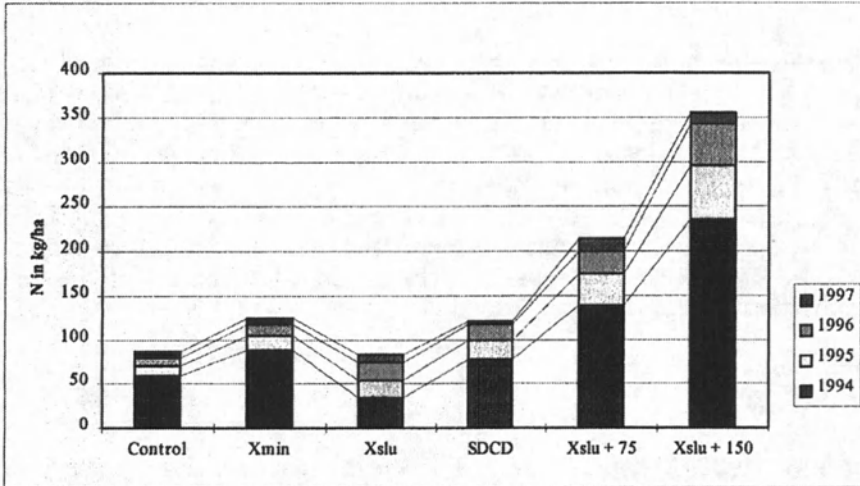

**Figure 2**  
 Comparison of dry matter yield (a) and N uptake (b) between  $X_{min}$  treatment and  $X_{slu}$  and  $S_{DCD}$  treatments, over the five years.



## Drainage and N leaching :

The cumulative amounts of nitrogen measured in the leachates are reported in figure3.



**Figure 3.**

*Cumulative amounts of nitrogen lost in the leachates, for all treatments (information on leaching in 1993 could not be used because watertightness of lysimeters wasn't perfect)*

The nitrogen lost in the leachate varied considerably between the different treatments and the different years ; the last two winter periods were drier than normal ( the water percolated was 70 mm in 1997 and 105 mm in 1995, compared to 280 mm in 1994). Weak nitrogen losses occurred during these « dry » winters on control,  $X_{min}$ ,  $X_{slu}$  and  $S_{DCD}$  treatments, whereas they remained much higher for the  $X_{slu + 75}$ ,  $X_{slu + 150}$  treatments. High N losses in 1994 were related to strong rainfall during the winter ; the lower N losses observed on  $X_{slu}$  compared to  $X_{min}$  treatment in 1994 could not be explained either by nitrogen quantity or by nitrogen distribution in the profile ; the N losses measured in  $X_{min}$  and  $X_{slu}$  after 1994 were quite similar.

The N leached from the  $X_{min}$  and  $S_{DCD}$  treatments was very similar for the four years, suggesting that no leaching of the slurry nitrogen added with DCD occurred during winter after spreading.

The N losses cumulated over four years attained 125 and 121 kg N ha<sup>-1</sup> for the  $X_{min}$  and  $S_{DCD}$  treatments respectively, implying that the « apparent additional pollution », obtained from the difference with the control treatment, was only 37 kg N ha<sup>-1</sup>. This « additional pollution » was low, representing 11.5 % and 4.4 % of the applied nitrogen for  $X_{min}$  and  $S_{DCD}$  respectively ; no additional pollution was recorded with the  $X_{slu}$  treatment, because of the low leaching in 1994.

On the other hand, nitrogen leaching greatly increased at the  $X_{lis+75}$  ( by 70 % ) and  $X_{lis+150}$  rates (by 190 %), compared to the  $X_{min}$  rate.

## Conclusion

This five-year lysimeter experiment enabled us to show that exclusive and « repeated » fertilization of corn with pig slurry was quite « sustainable », as it gave similar dry matter yields, compared to mineral nitrogen fertilization, and resulted in low levels of nitrogen losses. The results also suggest that the method used to calculate the nitrogen fertilizer rate seemed to strike an acceptable balance between high crop production and water quality. This method of agronomic management permitted valorization of spring and autumn applications of pig slurry over five years without any increase in water pollution, compared with the pollution obtained with mineral nitrogen fertilization.

## References

- Bertrand M.**, 1985. Méthode d'estimation de la valeur fertilisante des lisiers de porcs. Cemagref- Informations Techniques, Cahier 60: 2
- Boschi, V., Spallacci, P., Montorsi, M.**, 1981. The agronomic utilisation of pig slurry: effect on forage crops and on soil fertility. In: Nitrogen uptake by crops manured with pig slurry. Nitrogen losses and surface run-off -(Brogan, J.C, ed) Brussels - Luxembourg, 105-128.
- Carey, P.L., Rate, A.W., Cameron, K.C.**, 1997. Fate of nitrogen in pig slurry applied to a New Zealand pasture soil. Aust. J. Res., 35:4, 941-959.
- Chadwick, D.R ., Van der Weeden, T., Martinez, J., Pain, B.F.**, 1998. Nitrogen transformations and losses following pig slurry applications to a natural soil filter system (Solepur process) in Brittany, France. J. agric. Engng Res., 69, 85-93.
- Desvignes, P.**, 1995. Enfouir pour mieux valoriser. Perspectives agricoles. 207, 49-50
- Duthion, C.**, 1981. Nitrogen leaching after spreading pig manure. In: Nitrogen losses and surface run-off -(Brogan, J.C, ed) Brussels - Luxembourg, 274-283.
- Machet, J.M., Mary, B.**, 1990. Impact of agricultural practices on the residual nitrogen in soil and nitrates losses. In: Management systems to reduce impact of nitrates. Germon, P., ed .126-146.
- Morvan, T., Heumez, E., Bouthier, A., Masson, E., Cabaret, M.M.**, 1995. Un point clé: le fractionnement. Perspectives agricoles, 207, 40-46

**Morvan, T., Leterme, P., Mary, B., 1996.** Quantification des flux d'azote consécutifs à un épandage de lisier de porc sur triticales en automne par marquage isotopique  $^{15}\text{N}$ . *Agronomie*, 16, 541-552.

**Pratt, P.F., Broadbent, F.E. and Martin, J.P., 1973.** Using organic wastes as nitrogen fertilizers. *Calif. Agric.*, 27: 10-13.

**Remy, J.C., Hebert, J., 1977.** Le devenir des engrais azotés dans le sol. *CR Acad. Agric.*, 700-709.

**Schröder, J.J., Ten Holte, L., Van Keulen, H., Steenvoorden, J.H.A.M., 1993.** Effects of nitrification inhibitors and time and rate of slurry and fertilizer N application on silage maize yield and losses to the environment. *Fertilizer Research*, 34, 267-277.

**Sluismans, C.M.J. and Kolenbrander, G.J., 1977.** The significance of animal manure as a source of nitrogen in soils. In: *Proc. Int. Seminar of soil environment and Fertility Management in Intensive Agriculture*. Tokyo, Japan, 403-411.

**Smith, K.A, Chambers, B.J., 1992.** Improved utilisation of slurry nitrogen for arable cropping. *Aspects of Applied Biology*, 30, 127-134.

**Spallacci, P., 1981.** Nitrogen losses by leaching on different soils manured with pig slurry. In : *Nitrogen losses and surface run -off* -(Brogan, J.C, ed) Brussels - Luxembourg, 284-288.

**Spallacci, P., 1981.** Nitrogen uptake by crops manured with pig slurry. In: *Nitrogen losses and surface run -off* -(Brogan, J.C, ed) Brussels - Luxembourg, 178-180.

**Tietjen, C., 1981.** The yield efficient nitrogen portion in treated and untreated manure. In: *Nitrogen uptake by crops manured with pig slurry*. In: *Nitrogen losses and surface run -off* -(Brogan, J.C, ed) Brussels - Luxembourg, 129-141.

**Wouters, A.P, 1995.** New application techniques make slurry again a valuable nutrient. In: *Proceedings of the symposium: Applied Research for Sustainable Dairy farming*, 13-19.



**Chairman's summary of part 1 bis**  
**Management strategies for organic waste use in agriculture.**  
**Mike GOSS**

There were ten poster papers presented in this session, covering a wide range of topics, from the variability in the distribution of manure from slurry or solid manure spreaders to the regulatory system for manure management in the Lombard region of Italy.

Two papers were concerned with gaseous nitrogen losses from livestock facilities where deep litter was used. In the case of poultry barns, the loss of ammonia was greatly reduced if water from drinkers was kept out of the litter (Chiumenti and da Borsa). When pigs were raised on deep litter, the release of ammonia was much less than that from slurried manure handling systems. However, the release of nitrous oxide was much greater from the litter system than the slurry system. However, there was a major gap in the nitrogen balance for the litter system, which suggested that up to 70% of the nitrogen excreted could have been lost as di-nitrogen gas. In both cases, phosphorus was conserved (Robin *et al.*).

Animal welfare considerations has encouraged the development of pig rearing outdoors. This is not without environmental impacts. Soil structural damage resulted from the activities of the animals. Nitrate leaching was stimulated because of the excretal return to the soil, and toxic metals (copper and zinc) accumulated (Menzi *et al.*).

Land application of organic waste represents an alternative to landfilling or incineration, and allows nutrients and organic matter to be returned to agricultural soils. For effective use of these materials, including animal manure, the application needs to be uniform and the rates need to be precise. The performance of spreaders for solid and liquid wastes was investigated on grassland and arable soils (Smith and Baldwin). They reported that correct adjustment of the bout-width reduced the coefficient of variation in the spread-pattern. For solid spreading, rear-discharging units were found to give the most symmetrical spread pattern. Importantly, the precision of application was found to be less important for crop growth if the nitrogen requirements of the plants were met by a combination of mineral fertiliser and the organic waste. Nutrient management planning has become an important means of regulating livestock operations, and ensuring that appropriate application rates are used. The Lombard region of Italy has developed regulations, which include requirements associated with storage and land application of slurry (Provolo and Sangiorgi). Storage pits have to be designed to hold slurry for a minimum period between 110 and 210 days, depending on farm situations. The volume of manure that requires spreading is less than the nutrients needed for crops in the region, so the regulations should allow a balanced supply of nutrients to the land. Electronic records (using CIARA37 software) of the land application will be used to record the proposals submitted to the regulatory bodies. A Plant Health and Soil Conservation Inspectorate acts to evaluate the quality of materials. Registration requires the materials to satisfy physical and chemical analyses, phytotoxicity tests, human pathogenicity tests, and ecotoxicological tests.



**Part 2 bis**

**Agronomic value of organic wastes.**

**Chairman : M.-P. BERNAL (Spain)**





## **Valorisation of organic wastes in agriculture. Compostage supply for the use of organic matters as background nitrogen fertilizer.**

*Essais de valorisation des déchets en agriculture. Apport du compostage à l'utilisation d'amendements de matières organiques comme engrais azotés de fond.*

**Bouanani F\*, Domeizel M., Prone A.**

Laboratoire Chimie et Environnement, Case 29, Université de Provence,  
3 Place Victor Hugo, 13331 Marseille Cedex 3. Fax : 04 91 10 63 77.

E-mail : massiani@newsup.univ-mrs.fr

### **Abstract**

*Several experiments have been carried out in order to evaluate the compostage impact on organic matters and its influence on the nitrogen mineralization ability. Double-walls thermostated columns, kept at constant temperature and moisture (respectively 28°C and 75%), were used to study the nitrogen mineralization within 16 weeks, with various organic wastes added to two soils of different textures. A first attempt was investigated to compare the nitrogen mineralization after application of sewage treatment plant sludges and the same sludges composted with green materials. A second attempt allowed the comparison between chemical nitrogen fertilizer and lavender-straw compost, at two different total nitrogen ratios.*

Keywords : nitrogen, sludge, compost, fertilizer, lavender, mineralization, nitrate.

### **Résumé**

Plusieurs essais ont été réalisés afin d'évaluer l'impact du compostage sur les matières organiques et son influence sur le potentiel de minéralisation de l'azote. Des colonnes thermostatées, à doubles parois, maintenues à température et à humidité constantes (respectivement 28°C et 75%), sont utilisées pour étudier la minéralisation de l'azote pendant 16 semaines, dans deux sols de textures différentes, et après apports d'amendements d'origines diverses. Un test a permis de comparer la minéralisation de l'azote après épandage de boues brutes de station d'épuration, et de ces mêmes boues compostées avec des déchets verts. Un deuxième test a permis la comparaison des apports engrais chimiques azotés et compost de paille de lavande, à deux doses différentes d'azote total. Ces essais comparatifs ont mis en évidence la minéralisation de l'azote au cours des 16 semaines avec apparition des formes minérales de l'azote.

Mots-clés : azote, boue, compost, engrais, lavande, minéralisation, nitrate.

## **1. Introduction**

To face with the coming out of new constraints and more strict making of rules bound to wastes elimination, the valorisation of organic matters in agriculture represents a more and more promoting solution but which had to resolve few queries. Estimated models of the organic matters evolution, and especially for the nitrogen in the soil, are important and essential to manage the amendments valorisation. Thus, Campbell (1988) has verified nitrogen mineralization function of temperature and moisture. The same variables allowed Gunnar et al. (1990) to simulate the nitrogen dynamic in the soil. On the other hand, Serna (1992) has established an available nitrogen pattern function of the type of sludge and Douglas (1991) has studied the rate of available nitrogen to the crop growth, depending on soil characteristics, organic residues, time influence and application method of these residues. In our study, the bioavailability of organic amendments (sludges, composted sludges and straw-lavender compost) will be compared with chemical fertilizers in order to estimate the quantities to apply to compensate the nutrients losses. The implementation of accelerated mineralization experiments in thermostated lysimetric columns allow in a first time to compare the different amendments and to follow up in particular the composting influence. Another lysimetric experiments allow the comparison of the nitrogen biodisponibility in normal mineralization conditions, with wheat crop.

## **2. Materials and methods**

### **2.1. Treatments**

In accelerated mineralization conditions, organic amendment used is a straw-lavender compost being in a rustic composting maturation during six months on a pile of 2.000 tonnes. This amendment will be compared with chemical fertilizer (ammo-nitrate) and the nitrogen rates applied were chosen in accordance with agricultural methods practised in the region :  $15 \text{ t.ha}^{-1}$ . The amendments quantities have been estimated for a same total N ( $2 \text{ mg/g}$  dry matter) application for the columns "concentrated chemical fertilizer" and "concentrated compost". As regards the amendments containing sludges : sludges composted with green materials (noted BIOT), raw sewage sludge (BBA) and the same composted sewage sludges (CA) have been selected. The application rate was  $20 \text{ t.ha}^{-1}$  of dry matter.

The characteristics of the different amendments are resumed in table 1.

	organic C	total N	NTK	organic N	N-NH <sub>4</sub> <sup>+</sup>	N-NO <sub>3</sub> <sup>-</sup>
Straw-lavender compost	139	23,2	23	22,45	0,46	0,034
Chemical fertilizer	/	364	208	/	208	35,226
Biotechna compost	171,5	19,51	16,65	16,64	0,003	2,84
Arles compost	214,0	26,90	26,63	26,55	0,077	0,27
Raw sewage sludges from Arles	181,6	/	27,09	/	/	/

Results expressed as mg.g<sup>-1</sup> of dry matter

*Table 1*  
*Chemical characteristics of the materials*

## 2.2. Experimentation method

The study device of the nitrogen accelerated mineralization was constituted by double-walls thermostated columns (height = 25 cm and area of 0,0104 m<sup>2</sup>) allowing by warm water circulation to stay at a constant temperature. Essays with wheat crop, after application of straw-lavender compost, were conducted in normal conditions of temperature and at a constant moisture (75 % of the field total capacity). Through simulation models, temperature and moisture have been identified as being the decisive factors for the soil nitrogenous mineralization. Each column was kept at constant temperature, 28°C ± 1°C, and at a constant moisture corresponding to 75 % of the field total capacity, by regular watering. These values represent the optimal activity conditions for the microbial populations involved in the nitrogen cycle.

Treatments of straw-lavender compost and chemical fertilizer were studied on a soil coming from the Valensole plateau (Alpes de Haute-Provence, France). Samples of 20 g core soil (minimum amount required for the total chemical analyses) were removed every 3 weeks for 16 weeks. The sample was taken on the total height of the column, providing a representative soil sample. (Table 2: soil column constitution).

Thermostated column	Amendment t.ha <sup>-1</sup>	total N mg	Column with wheat crop	Amendment g of dry matter
1:Reference soil	0	0	T : Reference soil	0
2:Concentrated fertilizer	1,5	568	L : Straw-lavender compost	15,6
3:Fertilizer	0,15	56,8	E : Fertilizer	0,47
4:Concentrated compost	50	1206,4	LF : Straw-lavender compost with fowl droppings*	9,4
5:Compost	5	120,6		

\* Straw-lavender compost with fowl droppings 37,25 mg g<sup>-1</sup> of NTK.

*Table 2*  
*Soil column constitution*

Amendments from sewage sludges were compared on a soil representative of the brown mediterranean soils (cultivated site of Beaucueil, Provence Alpes Côte d'Azur, France). Samples of soil were removed on the upper tenth centimetre, for 16 weeks. These 10 cm corresponded to the vegetal sample area.

### 2.3. Steady parameters

All chemical analysis (table 3) were carried out on dry (60°C for 24h) and mixed samples. Results are expressed as mg.g<sup>-1</sup> of dry matter.

Parameter	Extraction	Technique
pH	Water. Ratio 1/5 (m/V)	pHmeter
NTK	Kjeldahl mineralization method	Acid-basic titration
NH <sub>4</sub> <sup>+</sup>	Water. Ratio 1/5 (m/V)	Colorimetric λ = 630 nm
NO <sub>3</sub> <sup>-</sup> / NO <sub>2</sub> <sup>-</sup>	Water. Ratio 1/5 (m/V)	Ionic chromatography
organic C	Anne mineralization method	Redox titration
organic N	Difference between NTK et NH <sub>4</sub> <sup>+</sup>	
UV spectra	Water. Ratio 1/5 (m/V)	200 to 350 nm, eye of 1 cm

*Table 3*  
*Analysis methods*

## 3. Results and discussion

### 3.1. Sewage sludges and composted sewage sludges comparison

Appearance of the nitrogen most mineral form, nitrate ion, occurred after 3 weeks of experimentation and the follow up of the NH<sub>4</sub><sup>+</sup> ion evolution showed a decrease of the concentration during the same time (results not given). Increasing of nitrate in soil was observed particularly in the BBA column, and lower in BIOT. In BIOT, a great increasing of nitrate was observed between the third and the sixth week, followed by a decreasing. The reference soil column marked a small increasing in the time of experimentation, showing that the mineralization was effective even though no organic matter was applied. The different structure in each column according to the type of amendment, could explain the different behaviour in the soil. Morel (1989) explain that the texture is bound to the structural qualities of the soil, which govern the mineralization process. Thus, compost particles formed dense aggregates in the BIOT column, conversely the mixture in the BBA column seemed to be more homogeneous. There was in this way a better mineralization in the BBA column, leading to a visible appearance of the nitrate ions.

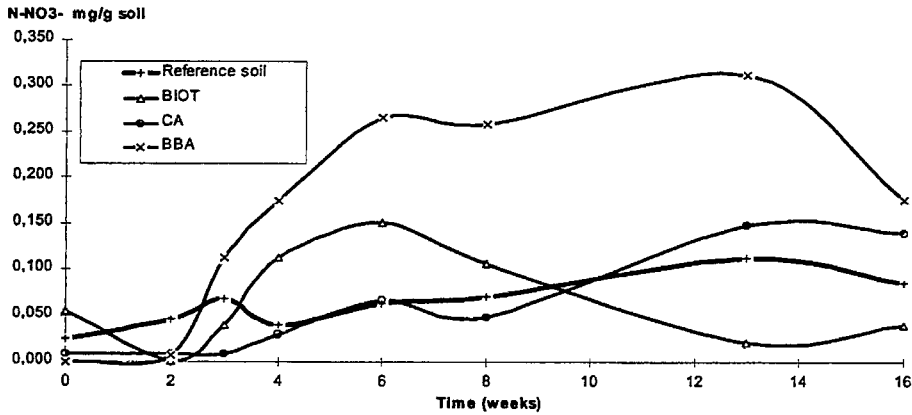
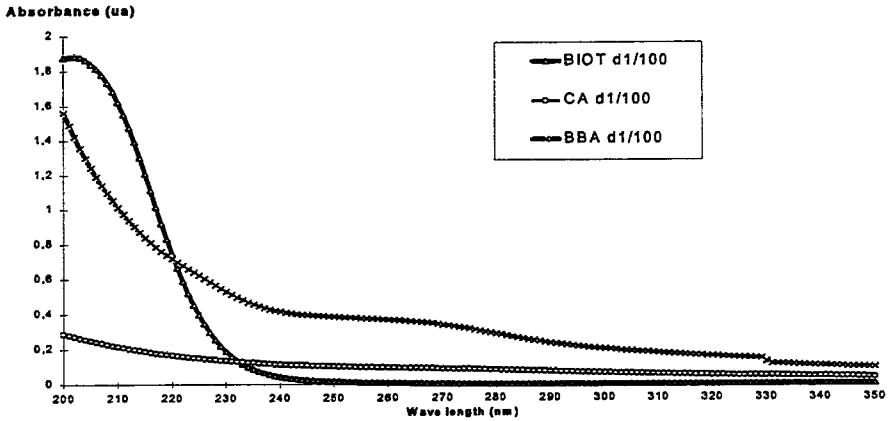

**Figure 1**  
Evolution of the nitrate with time ( $N-NO_3^-$  mg.g<sup>-1</sup> of soil)

The follow up of the organic nitrogen variations with the time (un published results), showed that the composted sewage sludges tend to immobilise nitrogen in an organic form. An increasing of the organic nitrogen was indeed observed in these columns at the eighth week while the concentration decrease in the BBA mixture. Sims (1990) has also done the similar observation with a study conducted with different composted sewage sludges, the nitrogen immobilisation noted in this case had repercussions on the growth crop studied. Composting could therefore reduce the available nitrogen rate but it could be used to provide slow organic fertilizers, since a nitrate increasing was observed in the mixture with composted sewage sludges after the twelfth week, while the concentration increase in a significant way in the BBA column. This increasing was probably due to a differed mineralization after a stage of immobilisation.

UV spectra study of the sewage sludges and composted sewage sludges showed in a global way an elevated absorbance value between 200 and 230 nm due to the presence of functional group and nitrates coming from mineralization (figure 2), and a shoulder between 230 and 280 nm, characterising the organic matter (Thomas et al., 1993).

The organic matter amount seemed to be more important in the Arles compost and in the raw sewage sludges while it was not detected in the Biotechna compost. The peak at 200-230 nm and the shoulder near 280 nm in the spectra of Biotechna compost extraction showed that this product was at an advanced mineralization level before its incorporation to the soil. This result is along the same line as the observations done in figure 1 where a nitrate swift decrease was observed (sixth week), decrease probably due to a lack of nitrogen. The Biotechna compost study, constituted from sewage sludges composted with green materials and bark shaving, confirm the experiments of Epstein (1978) who proved that composting with bark shaving decrease the mineralization ability.



**Figure 2**  
*UV spectra of the different organic matters applied (d : dilution)*

An increasing of the absorbance values with the time was noted in the absorption UV spectra of the soil mixtures extractions (figure 3a and 3b). The peak evolution in the low wave length was in connection with the nitrate concentrations and confirmed the observations of the figure 1. With the time, the shoulder decrease near 280 nm showed clearly the organic matter disappearance and therefore the organic matter mineralization.

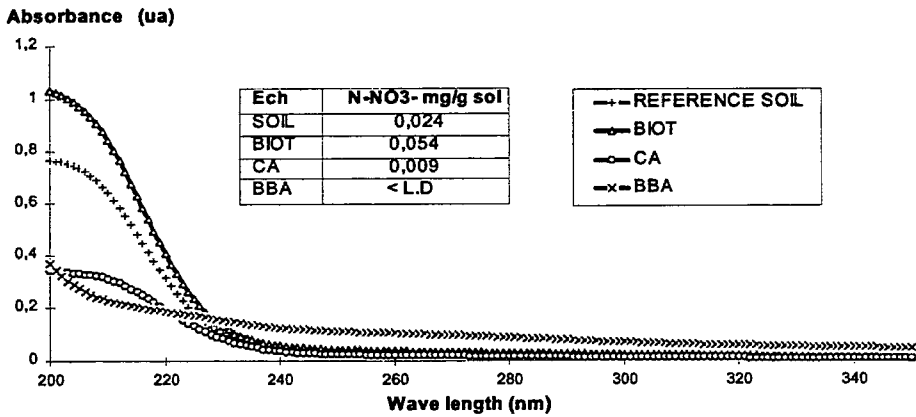

**Fig 3a**  
*Absorption UV spectra of the water soil mixtures extractions at initial time*

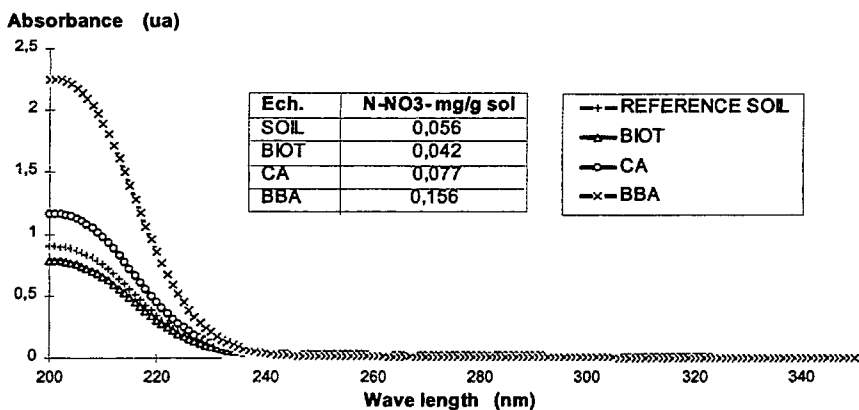

Fig 3b

Absorption UV spectra of the water soil mixtures extractions after 10 weeks

### 3.2. Straw-lavender compost and chemical fertilizer comparison

#### Accelerated mineralization

The experiment could be divided in two parts, mainly conditioned by the ammonium ions evolution. During the first period, the ammonium concentration remained high, providing sufficiently materials for nitrifying bacteria. Further 9 weeks, in spite of a 95% decrease of  $N-NH_4^+$  in the 5 columns, a nitrate concentration increasing was observed. This appearance of nitrate, differed with the time, could be attributed to a more or less rapid synthesis dynamic of this ion, according to the environment conditions.

After the nine first weeks, nitrate concentration decreased in favour of the organic compartment, in the “concentrated chemical fertilizer”, “chemical fertilizer” and “concentrated compost” columns. The decrease of the necessary material for nitrification ( $NH_4^+$ ), preventing the bacteria activity to continue the nitrification chain in a significant way, could not explain by itself the nitrification standstill. The presence of an important nitrate amount seemed to be one of the parameters responsible of the mineral nitrogen immobilisation in an organic form. Indeed, the results, showed the mineralization continuation beyond the 9 weeks in the “reference soil” and “chemical fertilizer” columns, which contain a small quantity of nitrate (respectively 0,036 and 0,037  $mg.g^{-1}$ ). In the other three columns, the nitrate ions evolution increased until the ninth week, then followed by a significant decrease. In the columns containing chemical fertilizer, this decrease was explained by the high initial nitrate concentration. As for the “concentrated compost”, a different behaviour was observed. While its nitrate concentration was close to the ones “reference soil” and “compost”, a great nitrate concentration was noted during the first nine weeks, allowing to reach a high value (0,243  $mg.g^{-1}$  of  $N-NO_3^-$ ), close to the initial value measured in the column containing concentrated

chemical fertilizer (0,252 mg.g<sup>-1</sup>). The addition of a sufficient quantity of compost led to a good aeration, favouring the mineralization. After nine weeks, this aeration was no longer able to compensate the high nitrate rate, and then a significant loss of nitrate was observed.

The quantities of organic amendments applied were governed by the farming methods in the region where the soil sample were taken, this explain the use of the “chemical fertilizer” column as a reference. The high degree of nitrate decrease which occurred in the column containing ten times more chemical fertilizer, could be a sign for a similar risk in a field. It is therefore important to not apply a too high quantity of mineral chemical fertilizer. The wanted objective is then no more reached and there would be a risk to obtain the opposite effect : a significant loss of bioavailable nitrogen, i.e. nutritive substances. However, this observation has to be tempered since the presence of crop in fields consume generally all or a part of the nitrates.

### Cultivated columns

In the columns with wheat crop, an experiment cut in two phases was also observed since the ammonium ions decreased significantly after the nine first weeks. At this experimentation level, a change of the nitric ions was as well detected (figure 4). In fact, the nitrate concentration decreased in a significant way for the cultivated columns, while this parameter remained at a constant level in the non-cultivated columns. The results showed a different mineralization dynamic according to the presence or absence of a vegetal cover. The nitrate appearance was indeed more late in the columns without crop, as if the crop presence would have “boost” the mineralization.

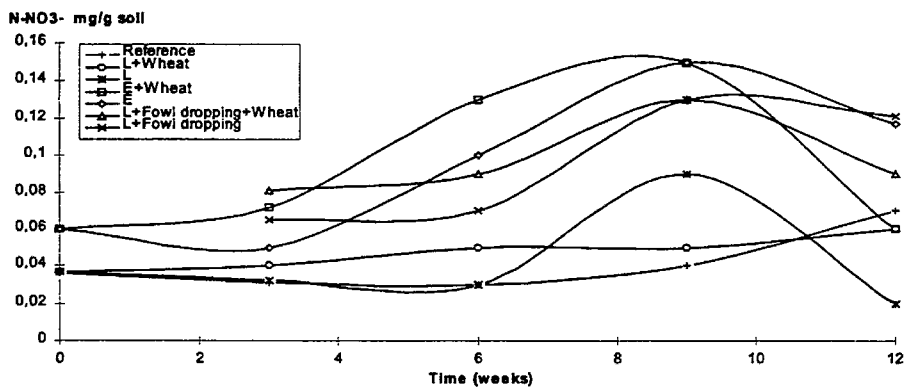

**Figure 4**  
Nitrate evolution with the time in cultivated columns

This experimental period (9 weeks) seems important since it corresponds both at a period of nitrogen plant uptake, and at a mineralization slowing down. The results show the importance of the amendment period choice. The perfect knowledge of



the mineralization phenomenon is therefore important to perform the organic matters application and avoid any risk of ground water pollution or nutritive substances losses.

The addition of fowl-droppings to straw-lavender compost didn't entail any change of the nitrogen mineralization dynamic. This co-product would even so provide a complement since the mineral nitrogen quantities were more important, the graph of the straw-lavender compost with addition of fowl droppings column was always higher as the graphs corresponding of the straw-lavender compost column. So, the application of fowl-droppings with straw-lavender compost could offset the defects of straw-lavender compost by an useful great supply of nitrates.

#### **4. References**

- Campbell C.A., Jame Y.W. & De Jong R., 1988.** Predicting Net Nitrogen Mineralization over a Growing Season : Model Verification. *Can. J. Soil Sci.*, August, 68, 537-552.
- Douglas B.F. & Magdoff F.R., 1991.** An Evaluation of Nitrogen Mineralization Indices for Organic Residues. *J. Environ. Qual.*, Vol.20, April-June, 368-372.
- Epstein E., Keane D.B., Meisinger J.J. & Legg J.O., 1978.** Mineralization of Nitrogen from Sewage Sludge and Sludge Compost. *J. Environ. Qual.*, Vol.7, N°2, 217-221.
- Gunnar Ch. Borg, Per-Erik J. & Börje L., 1990.** Simulated and Measured Nitrogen Conditions in a Manured and Fertilised Soil. *Plant & Soil*, 121, 251-267.
- Morel R., 1989.** Les sols cultivés. *Technique & Documentation. Lavoisier.*
- Serna M.D., Pomares F., 1992.** Nitrogen Mineralization of Sludge-Amended Soil. *Bioresource Technology*, 39 : 285-290.
- Sims J.T., 1990.** Nitrogen Mineralization and Elemental Availability in Soils Amended with Cocomposted Sewage Sludge. *J. Environ. Qual.*, 19, 669-675.
- Thomas O., Théraulaz F., Domeizel M., Massiani C., 1993.** UV spectral deconvolution : a valuable tool for waste water quality determination. *Environmental Technology*, 14, 1187-92.

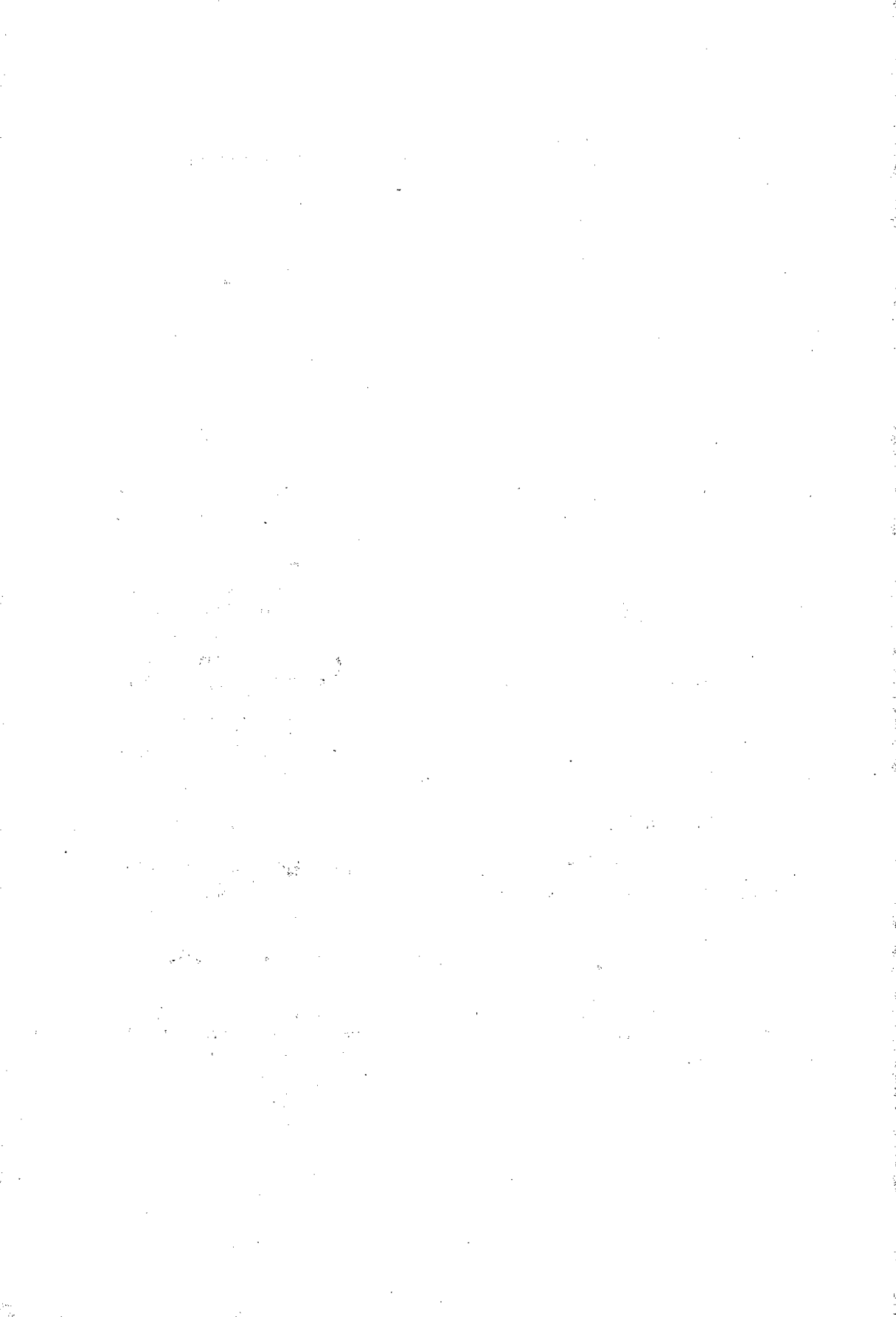

## **Agronomic value of alkaline stabilised sewage sludge solids**

*Valeur agronomique de boues de station d'épuration solides,  
stabilisées par alcalinisation.*

**P. Christie\* and D.L. Easson**

Agricultural and Environmental  
Science Division, Department of  
Agriculture for Northern Ireland,  
Newforge Lane,  
Belfast BT9 5PX, UK  
E-mail : PChristie@compuserve.com

**J.R. Picton**

Greenmount College of Agriculture and  
Horticulture, Antrim BT41 4PU.

**S.C.P. Love**

Northern Ireland Water Service,  
39 Slaght Road, Ballymena BT42 2JE. UK

### **Abstract**

*« Agri-Soil » is an organic fertiliser made by mixing dewatered sludge (32-35 % DM) with cement kiln dust and composting aerobically in windrows. Two field experiments compared the P or K value of Agri-Soil for five consecutive annual spring barley crops with inorganic fertiliser P or K. All Agri-Soil and inorganic fertiliser treatments gave higher yields than controls, but there was no yield response to increasing application rate of Agri-Soil or fertiliser P or K. Yields of sludge amended or fertilised plots were therefore averaged over the five crops and compared. Agri-Soil gave higher mean grain yields than fertiliser P or K, higher thousand grain weights and more grains per ear than KCl (not determined for fertiliser P) and higher straw yield than fertiliser P. These effects may have been due to, inter alia, higher soil pH and alleviation of sulphur deficiency.*

*Keywords : Alkaline sewage solids, barley yield, nitrogen, phosphorus, potassium, sulphur*

### **Résumé**

« Agri-sol » est un fertilisant organique préparé par mélange de boues de station d'épuration déshydratées (32-35% de MS) et de poussière de « ciment » compostée en andains. Deux essais au champ ont permis de comparer la valeur phosphatée et potassique de Agri-sol au cours de cinq essais agronomiques sur orge de printemps avec fertilisants chimiques P ou K. Tous les traitements avec Agri-sol et engrais chimiques présentent de meilleurs rendements que les témoins, mais on n'a pas obtenu de courbe de réponse à des doses croissantes de Agri-sol ou de fertilisant P ou K. Les rendements des cultures amendées avec Agri-sol ou fertilisées ont donc été moyennés sur les cinq cultures et comparés. Agri-sol entraîne de meilleurs rendements en grain comparativement aux engrais P et K, un poids de mille grains plus élevé et plus de grains par épi et un meilleur rendement en paille que le fertilisant P. Ces effets sont peut-être dus, entre autre, à un pH plus élevé et à une moindre carence en soufre.

Mots-clés : boues solides basiques, rendement orge, azote, phosphore, potassium, soufre.

## 1. Introduction

The Water Service of the Department of Northern Ireland has developed the Agri-Soil process for the alkaline stabilisation and composting of sewage sludge solids prior to land spreading as a means of sludge disposal. The initial pH of the mixture of sludge and kiln dust rises above 11.0 to kill pathogens and suppress odours and declines to about 7.8 after composting. Heat generated during the composting stage further contributes to pathogen kill and increases the dry matter content of the product. Agri-Soil contains less N and P than raw sludge cake but has a relatively high K content derived from the kiln dust. It has a neutralising value (CaCO<sub>3</sub> equivalent) of 30 % (DM basis).

This paper outlines the process and describes two field experiments on contrasting soils in which the agronomic value of the product for spring barley has been investigated for five consecutive years. Some of the results from the K experiment have been reported briefly (Christie & Easson, 1997).

## 2. Material and Methods

### 2.1. The Agri-Soil Process

The Agri-Soil process was developed by Love (1990) and is shown schematically in Fig. 1. Screened and picket fence - thickened rural sludge is mixed with a cationic polyacrylamide polyelectrolyte solution to act as a flocculant and passed through a modified belt press. The solids (30-35% DM) are then mixed in a ratio of 65:35 w/w with cement kiln dust. The mixture is composted by turning daily in windrows under cover for five days to produce a short-term unstabilised material with 50-55 % DM. This can then be turned regularly in the open for a further 45 days to achieve organic stability and a DM content of 75-80 %. This process differs from the 'N-Viro Soil' process (Burnham *et al.*, 1992) in its use of composting rather than accelerated drying.

### 2.2. The Field Experiments

The P experiment was established on a basaltic clay at Muckamore near Antrim (Irish Grid Reference J170839). Sludge cake was applied to plots (each 2.5 x 15 m) at rates of 17, 34, 51 and 68 t DM ha<sup>-1</sup>. Triple superphosphate was applied to other plots at rates of 17, 35, 52 and 70 kg P ha<sup>-1</sup> calculated to give approximately the same range of available P application rates assuming 50% availability of sludge total P. The actual application rates of total sludge P averaged 39, 78, 117 and 156 kg ha<sup>-1</sup>. Controls received no P applications, but supplementary N and K were applied where necessary to prevent yield responses to N or K. Lime (3 t ha<sup>-1</sup>) was applied before the first crop in 1992 to raise soil pH to the target value for an organic soil (16 % OM) of 6.4 (MAFF, 1994).

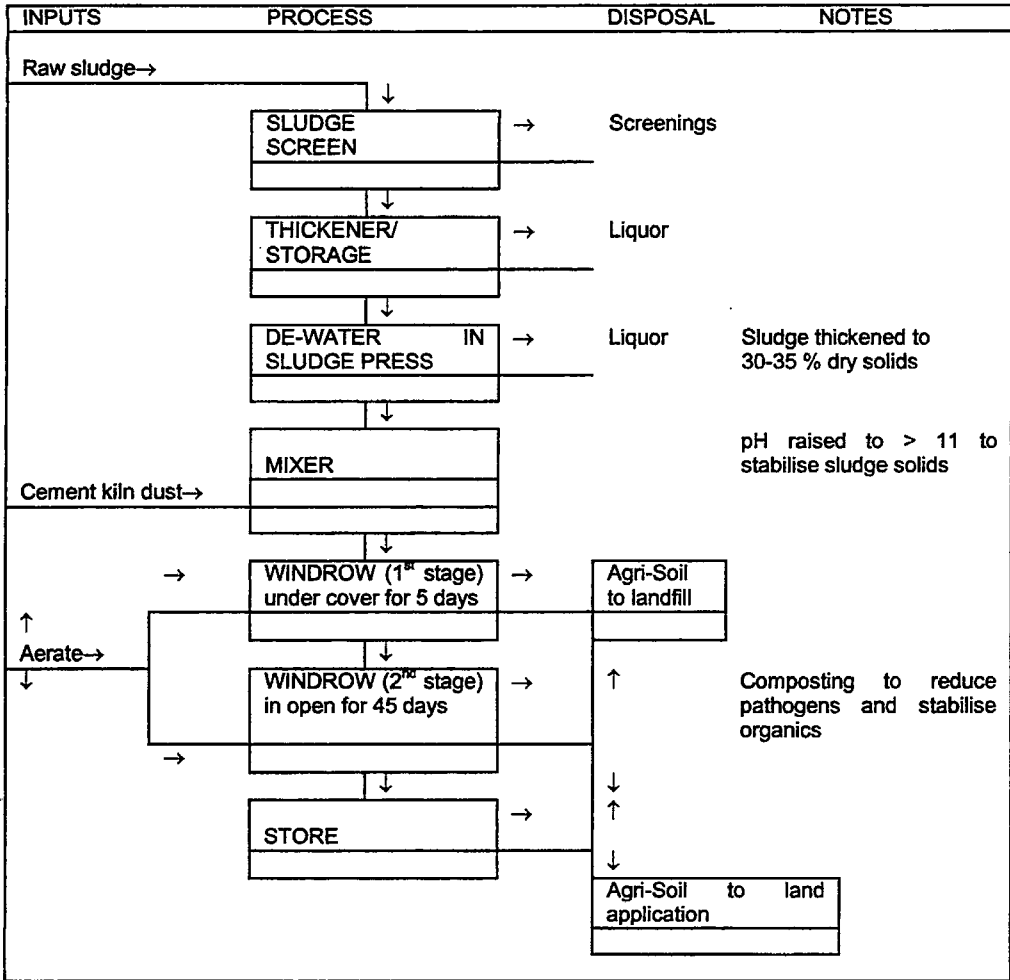

Figure 1  
Agri-Soil process flow diagram

The K experiment had a similar design and was established in 1992 at Corcreeny near Hillsborough, County Down (Grid Reference J208588) on a sandy loam derived from Silurian shale and Triassic sandstone. Agri-Soil was applied to plots (each 4 x 20 m) at rates of 4, 8, 12 and 16 t DM ha<sup>-1</sup>. KCl was applied to other plots at application rates of 42, 83, 124 and 166 kg K ha<sup>-1</sup> calculated to give approximately the same range of K application rates. Fertiliser K application rates were based on analysis of batches of Agri-Soil made in early 1992, but subsequent batches were higher in K and the actual application rates of K in the sludge product averaged 73, 146, 219 and 292 kg ha<sup>-1</sup>. Controls received no K applications, but supplementary N and P were applied where necessary to bring the total application of N and P up to recommended rates for the UK (MAFF, 1994) so that any yield responses could not be attributed to N or P. Lime (2 t ha<sup>-1</sup>) was applied to raise soil

pH to the target value for the mineral soil (4 % OM) of 6.7 (MAFF, 1994).

Spring barley (*Hordeum vulgare* cv. Forrester in 1992 and 1993 and cv. Chariot from 1994 to 1996) was grown at both sites. There were four replicates of nine treatments in a randomised block, giving a total of 36 plots at each site. Shoot samples were collected at the tillering stage for nutrient analysis. At harvest the grain and straw from the centre of each plot were harvested and weighed and samples collected for chemical analysis. Subsamples of grain from the K experiment were used to determine the proportion of dirt present (average < 2 %), the hectolitre weight and thousand grain weight TGWT) and plant, tiller and head densities were counted.

Soil properties were determined on composite samples collected to 15 cm depth every February using standard methods (MAFF, 1986). Plant N was determined by Dumas combustion. Other plant nutrients were determined by inductively coupled plasma atomic emission spectrometry (ICP-AES) following digestion in HNO<sub>3</sub>. The mean yield and grain quality results for five consecutive annual crops were tested by analysis of variance.

Site	Date	DM %	Total N	Total P	Total K
				g kg <sup>-1</sup> DM	
Antrim: Basaltic till clay with low available P status					
Mean	1992-1996	58.7	7.21	2.29	17.7
Hillsborough: Silurian shale sandy loam with low available K status					
Mean	1992-1996	58.3	7.88	2.46	18.3

*Table 1*  
*Dry matter (DM, %) and N, P and K (mg kg<sup>-1</sup> DM) composition of the batches of Agri-Soil used from 1992 to 1996*

### 3. Results

The DM, N, P and K concentrations of the batches of Agri-Soil applied from 1992 to 1996 are shown in Table 1. The product varied widely in DM content because the batches were not all composted for 50 days. Those applied in 1995 and 1996 were fully composted and stabilised. Mean grain and straw yields at both sites and crop quality measurements at Hillsborough are presented in Table 2. Agri-Soil produced higher grain yields than fertiliser P or K and gave higher straw yield than fertiliser P on the basaltic clay. The sludge product also gave higher grain weight and numbers per ear than fertiliser K at Hillsborough. The density of barley plants, tillers and heads was the same using fertiliser K and Agri-Soil.

Table 3 shows the soil pH (1:2.5 soil:water), bicarbonate-extractable P and exchangeable K in February 1992 (before the start of the experiment) and in February 1997 (after five annual crops). The most marked effects of the Agri-Soil were its liming effect and the increase in soil exchangeable K status. These were

more pronounced at Antrim because of the higher application rates at this site. The increases in soil exchangeable K reflected the relatively high K content of the organic manure.

Treatment	Antrim: Basaltic clay		Hillsborough : Silurian shale and Triassic sandstone sandy loam							
	Grain yield	Straw yield	Grain yield	Straw yield	Hectolitre weight	TGWT	Grain number	Plants	Tillers	Heads
Control	3.47c <sup>a</sup>	1.68b	4.36c	2.11b	62.6c	36.8c	17.0c	307a	806b	578b
Fertiliser P or K	4.24b	1.93b	5.34b	2.62a	63.6b	38.0b	18.0b	316a	922a	645a
Sludge cake	4.70a	2.54a	5.62a	2.61a	64.3a	38.5a	18.4a	313a	919a	667a
Significance <sup>b</sup> of :										
Treatment	***	**	***	***	***	***	***	NS	***	***
P or K source	***	***	*	NS	***	***	**	NS	NS	NS
P or K level	NS	NS	NS	NS	NS	NS	NS	NS	NS	NS
Trtmt X P or K source X P or K level	NS	NS	NS	*	NS	NS	NS	NS	NS	NS

<sup>a</sup>Means within each column followed by the same letter are not significantly different by least significant difference at the 5% significance level.

<sup>b</sup>By analysis of variance: \*\*\*, P<0.001; \*\*, P<0.01; \*, P<0.05; NS, not significant.

Table 2.

Mean yields of grain (15 % moisture content, t ha<sup>-1</sup>) and straw DM, t ha<sup>-1</sup> at Antrim and Hillsborough and grain hectolitre weight (kg), thousand grain weight (TGWT, g), number of grains ear<sup>-1</sup>, and plant population data (all no. m<sup>-2</sup>) at Hillsborough for five consecutive annual spring barley crops.

Date (Feb.)	Antrim: basaltic clay				Hillsborough: Shale sandy loam			
	Treatment (ha <sup>-1</sup> )	pH	P	K	Treatment (ha <sup>-1</sup> )	pH	P	K
1992	None	5.9 <sup>a</sup>	8	160	None	6.2 <sup>b</sup>	42	116
1997	0 (Control)	6.9	5	175	0 (Control)	6.4	29	75
	17 kg P	6.8	9	152	42 kg K	6.5	29	108
	35 kg P	6.8	9	146	83 kg K	6.9	35	173
	52 kg P	7.0	12	166	124 kg K	6.6	34	160
	70 kg P	7.1	20	170	166 kg K	6.4	29	175
	39 kg Sludge P	7.9	13	419	73 kg Sludge K	7.1	33	123
	78 kg Sludge P	8.0	20	653	146 kg Sludge K	7.4	35	159
	117 kg Sludge P	8.0	28	799	219 kg Sludge K	7.6	35	196
	156 kg Sludge P	8.1	32	110	292 kg Sludge K	7.4	34	204
				3				

<sup>a</sup>3 t and <sup>b</sup>2 t lime ha<sup>-1</sup> were applied before the first crop in 1992

Table 3.

Soil pH (in water), Olsen P (mg l<sup>-1</sup>) and exchangeable K (mg l<sup>-1</sup>) before the experiments (1992) and after five consecutive annual barley crops (1997).

The nutrient status of the barley shoots at the tillering stage allows comparison between the nutrient supplying capacity of the different treatments (Table 4). The most consistent effect over both sites was the higher concentration of S in the shoots receiving Agri-Soil, with the sole exception of the 1994 crop at Hillsborough.

## 4. Discussion

Agri-Soil produced higher barley grain yield on average at both sites (and higher grain quality at Hillsborough) than inorganic sources of fertiliser P or K over a five-year period of continuous cropping. Straw yield was also higher at Antrim and unaffected at Hillsborough. This was unlikely to be due simply to the higher range of P or K application rates in the sludge product because there was no yield response to increasing Agri-Soil or inorganic fertiliser application rate at either site.

Another possible explanation is that the sludge solids may have improved soil condition by supplying additional carbon. However, this is unlikely to be an important factor because the Hillsborough soil has a relatively high organic C content for a temperate mineral soil (2.4 % in the top 15 cm) and the Antrim clay would be classified by MAFF (1994) as an organic soil. A more likely explanation is that the high soil pH maintained by the sludge product may have contributed to the yield effect, together with alleviation of S deficiency. These two factors may have interacted with plant growth. Murphy (1990) described the low atmospheric inputs of S to soils in Ireland and reported responsiveness to S in Irish sandy soils with less than 3 % organic C. Sulphur in Agri-Soil is derived not only from the sewage sludge, but also from the cement kiln dust which typically contains 5 % S (Love, 1990).

It is unlikely that S is the only nutrient involved in the yield response to Agri-Soil. Mean offtakes of N, P, K and S in grain and straw were all higher in the Agri-Soil treatments than the fertilised plots (data not shown). Although the product does not have a high N concentration, its liming effect may have stimulated mineralisation of soil organic N, especially in the organic basaltic clay, an effect observed in forest soils to which Agri-Soil was applied (Luo & Christie, 1995). Thus, lime stabilised and composted sludge solids from rural sludges with relatively low concentrations of heavy metals may be a useful seedbed fertiliser for cereals when incorporated into nutrient management plans.

## 5. References

**Burnham, J.C., Hatfield, N., Bennett, G.F. & Logan, T.J.** (1992). Use of kiln dust with quicklime for effective municipal sludge pasteurisation and stabilisation with the N-Viro Soil process. In: Walker, D.D. *et al.* (eds) *Innovations and Uses for Lime*. American Society for Testing and Materials, Philadelphia.

**Christie, P. & Easson, D.L.** (1997). Alkaline stabilised sewage sludge cake as an organic fertiliser for spring barley. In: Ando, T. *et al.* (eds) *Plant Nutrition - For Sustainable Food Production and Environment*, pp. 589-590. Kluwer Academic Publishers, Dordrecht.



**Love, S.C.P.** (1990). Developments in sludge treatment. *Paper presented to the Institution of Water and Environmental Management, Dublin*. Department of the Environment for Northern Ireland, Belfast.

**Luo, Y.M. & Christie, P.** (1995). Some short-term effects of a lime-stabilised sewage sludge applied to arable and forest soils. *Irish Journal of Agricultural and Food Research* 34, 78.

**MAFF** (1986) Ministry of Agriculture, Fisheries and Food. *The Analysis of Agricultural Materials*, 3<sup>rd</sup> edn. Reference Book 427. HMSO, London.

**MAFF** (1994) Ministry of Agriculture, Fisheries and Food. *Fertiliser Recommendations*, 6<sup>th</sup> edn. Reference Book 209. HMSO, London.

**Murphy, M.D.** (1990). Fifteen years of sulphur research in Ireland. *Sulphur in Agriculture* 14, 10-12.



# Survival of manure-derived pathogens in soil

*Survie de pathogènes liés aux déjections dans le sol.*

**D. Cools, G. Van der Velde, R. Merckx, K. J. Verhaegen.**  
**Vlassak**  
KULeuven, Lab. of Soil Fertility and Soil Biology, K. Mercierlaan 92,  
3001 Heverlee. Belgium.  
E-mail : danielle.cools@agr.kuleuven.ac.be

KULeuven, Lab. of Bacteriology.  
UZ St-Raphaël, Capucijnevoer 33,  
3000 Leuven. Belgium.

## Abstract

*We studied the survival of Escherichia coli and Enterococcus spp from pig manure in soil at different temperatures (5, 15, 25°C) and variable moisture contents (40%, 80%, 100% of Water Holding Capacity) and at different manure application rates (3.5, 7, 14 l/m<sup>2</sup>). The manure applied contains 10<sup>6</sup> to 10<sup>7</sup> CFU/ml of E.coli and enterococci.*

*Preliminary results indicated that during the first 68 days enterococci survived better than E. coli, at all temperature and moisture levels. Moisture content did not affect the survival of either species. Both survived well at a level above the detection limit (DL = 10<sup>3</sup> CFU/g soil), at all moisture contents at 5°C.*

Keywords : survival, pathogenic bacteria, manure, soil.

## Résumé

Nous avons étudié la survie des bactéries *Escherichia Coli* et *Enterococcus spp* apportées par le lisier de porc à un sol à différentes températures (5, 15, 25°C) et à différents taux d'humidité (40%, 80%, 100% capacité au champ) et pour différentes doses d'apports (3, 5, 7 et 14 l/m<sup>2</sup>).

Le lisier apporté contenait 10<sup>6</sup> à 10<sup>7</sup> UFC/ml de *E-Coli* et enterococci. Les résultats préliminaires indiquent qu'au cours des premiers 68 jours, enterococci survit mieux que *E.Coli* pour toutes les températures et niveaux d'humidité testés. Le niveau d'humidité n'influence nullement la survie de chacune de ces 2 espèces. Toutes deux se situent au dessus du niveau de détection limite (DL = 10<sup>3</sup> UFC/g sol) quelque soit l'humidité et à 5°C.

Mots-clés : survie, bactéries pathogènes, déjections, sol.

## 1. Introduction

The use of antibiotics in animal husbandry, as well as research on its implications for human health began in the mid 1940's. Scientists concluded that the use of antibiotics in animals selected for resistant bacteria, may serve as a reservoir of antibiotic-resistant pathogens. A direct link to human health remained to be determined, since transfer of bacteria from animals to humans was a rare event (Sundlof, 1997). Antibiotics are nowadays used in meat production with three purposes : to cure an illness (therapy), to prevent possible pathology (prophylaxis) and to promote growth (as feed additives). Over the last 10 years, the discussion on the role of antibiotics used as additives in livestock feed ran high.

One can not deny that resistance to antibiotics of gut flora increased significantly in animals and humans. In Denmark, vancomycin-resistant enterococci of broiler flocks were isolated from faeces in 11 of 12 farms (92 %) where avoparcin was used as a feed additive. In the non-avoparcin group, only 2 out of 12 farms (17 %) yielded vancomycin-resistant isolates (Bager et al., 1997). The prevalence of resistant *Escherichia coli* in Danish pigs increased between 1970-71 and 1987-88 from 63 % to 100 % (Aalbaeck et al., 1991). Likewise, the widespread use of antibiotics in human medicine encouraged the rapid emergence of resistant bacteria, that become a part of the commensal flora of healthy individuals. The prevalence of vancomycin-resistant enterococci in Europe rose from 0 % to 20 % between 1986 and 1992 (Corpet, 1996). In Germany, the occurrence of ampicillin-resistant *E. coli* isolated from intensive care units is about 50 to 60 %. For general wards, ampicillin-resistant *E. coli* represents 30 % (Shah et al., 1993).

The emergence of an increasing number of resistant bacteria raises concern about their spread in the environment. The possible routes of transmission of antibiotic-resistant bacteria to humans are presented in figure 1. Direct contact with faeces of an infected animal or person, as well as indirect contact with contaminated soil, water or food can result in the transmission of potentially pathogenic bacteria (Donnelly et al., 1997). Most routes of transmission are well-documented and show that infections originate due to a lack of hygiene while handling animals or animal products.

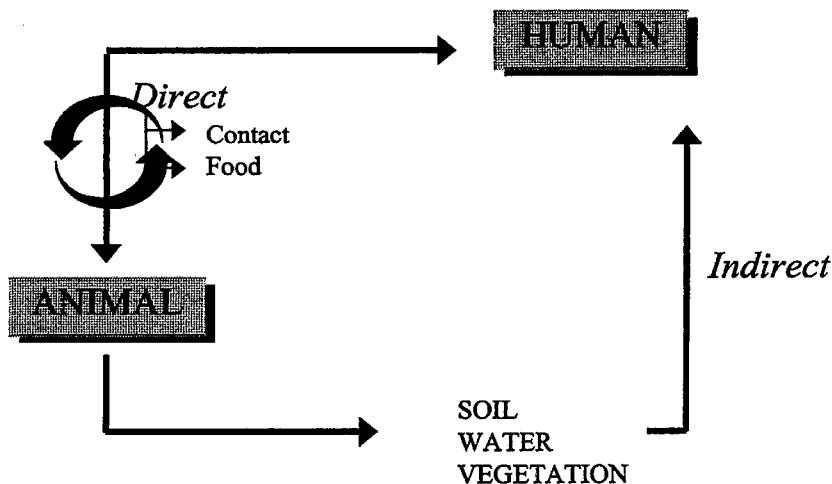

Figure 1

Possible routes of transmission of antibiotic resistant bacteria to humans.

Little is known about the role of the soil as a transport medium for resistant bacteria after waste disposal on fields. The survival of bacteria is influenced by many parameters, such as temperature, soil water content, pH, soil type, presence of other micro-organisms, etc. *E. coli* and *Enterococcus* spp are not common soil bacteria but are normal inhabitants of the intestinal tract of humans and animals, which can cause nosocomial outbreaks in immunocompromised patients. The optimum temperature for growth is about 37 °C, with a pH range from 6 to 7. After excretion, these potentially pathogenic bacteria can survive well in slurry, which is a mixture of faeces, urine and water. Land spreading of these slurries so seems an obvious factor in the dispersion of antibiotic resistant organisms.

We studied the survival of *E. coli* and *Enterococcus* spp from pig manure in soil at different temperatures, moisture contents and manure application rates.

## 2. Materials and methods

In a first experiment the influence of temperature and moisture content was studied by incubating soil cores with 5 different treatments : (Temperature = T, Moisture Content = MC, Water Holding Capacity = WHC)

1. T = 5 °C, MC = 100 % WHC
2. T = 5 °C, MC = 80 % WHC
3. T = 5 °C, MC = 40 % WHC
4. T = 15°C, MC = 100 % WHC
5. T = 25 °C, MC = 100 % WHC

For all treatments, a loamy textured soil (570 g) was used, homogeneously mixed with pig manure (60 g) which contained about  $10^6$  cfu/g of *E. coli* and  $10^6$  to  $10^7$  cfu/g of *Enterococcus* spp. As a tracer we added 1 ml of a solution containing  $10^8$  cfu/ml of temocillin-resistant *E. coli*.

With the same soil and manure, a second series of soil cores was incubated, where pig manure was added on the soil surface instead of incorporating it into the soil. Bacterial counts (for the three species) were determined by dilution plating at day 1, 5, 8, 12, 19, 26, 40, 54 and 68.

At the time of analysis, 1 g of topsoil and 1 g of subsoil (about 8 cm depth) were both diluted in 10 ml of physiological water (OXOID, BR 053 G), homogenized by vortex and inoculated on PTX agar (OXOID CM 943 B) (for all *E. coli*), MacConkey agar (OXOID CM 115) containing temocillin (for temocillin-resistant *E. coli*) and Enterococcosel agar (BBL 12205) (for enterococci). Plates were incubated at 37 °C for 24 or 48 h. Enrichment experiments were done for samples in which no bacteria could be detected by direct plating. Therefor, 10 g, 1 g and 0.1 g of soil were diluted in 10 ml of Tryptone Soya Broth (OXOID CM 129), incubated for 24 hours and inoculated on PTX, MacConkey and Enterococcosel.

The survival of *E. coli* and *Enterococcus* spp under different manure application rates was studied for a shorter period of time in a third experiment. A loamy textured soil (114 g) was used for all treatments, homogeneously mixed with a dose of 12 g (410 ton/ha), 6 g (205 ton/ha) or 3 g (102 ton/ha) of pig manure. As a tracer, 0.25 ml (containing  $1.10^8$  cfu/ml) of a temocillin-resistant *E. coli* was added to each treatment. Bacterial counts were determined on day 1, 5, 8 and 12. One g of soil was diluted in 10 ml of physiological water, shaken and inoculated on PTX agar, MacConkey agar containing temocillin, and Enterococcosel agar. Plates were incubated at 37 °C for 24 or 48 h.

### 3. Results and Discussion

Preliminary results indicate that during the first 68 days, *E. coli* and *Enterococcus* spp both survive very well in the soil. *Enterococcus* spp survive better than *E. coli*. Bacterial counts of *Enterococcus* spp decrease with 1 logarithmic unit (LU) after 68 days, whereas counts of *E. coli* decrease with 1.5 to 2 LU. Bacteria in the topsoil show a prolonged survival compared to bacteria in subsoil.

The influence of moisture content at 5 °C on bacterial growth is presented in figure 2. *E. coli*, as well as *Enterococcus* spp survive well at levels above detection limit.

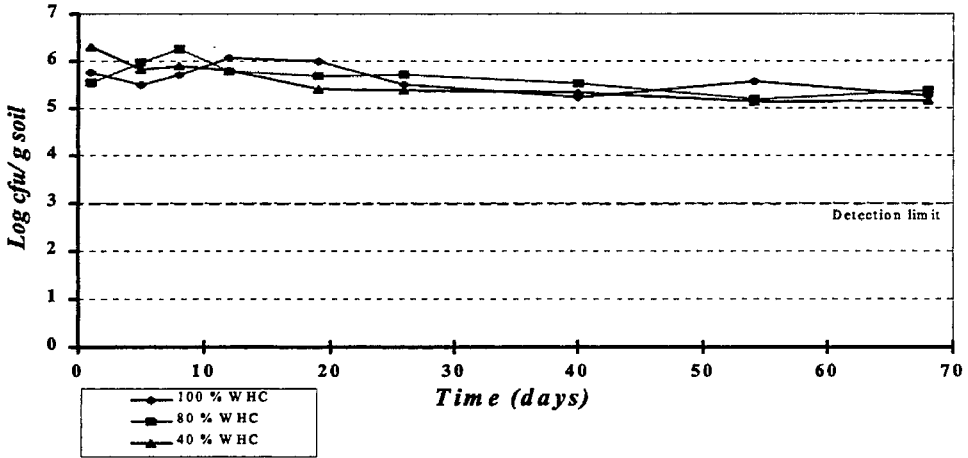

Figure 2a  
Survival of *Enterococcus* spp at different moisture levels (topsoil)

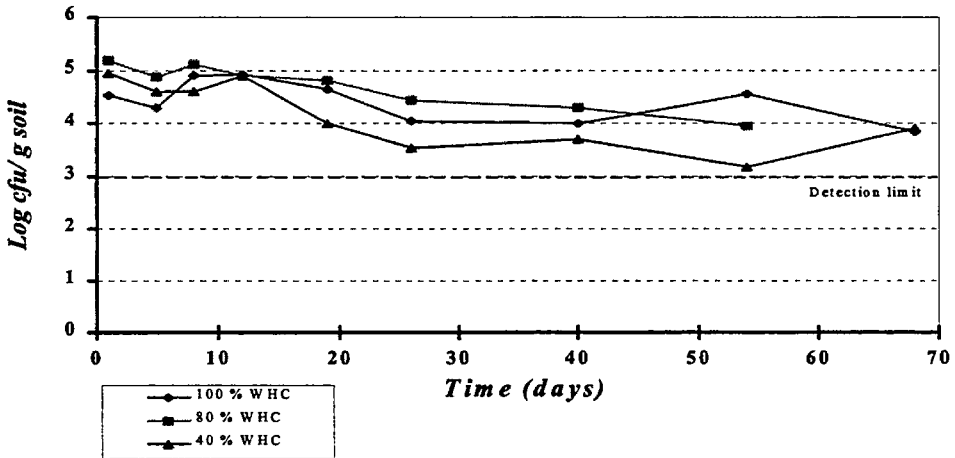

Figure 2b  
Survival of *E. coli* at different moisture levels (topsoil)

Increasing the temperature causes a decreased survival of both species, as shown in figure 3. Sixty-eight days after inoculation (dai), *E. coli* survive well at 5 °C and show a bacterial count of about 10<sup>3</sup> cfu/g soil at 15 °C. At 25 °C, detection is only possible until 40 to 50 dai. Enrichment of the soil however indicates that *E. coli* did not completely vanish. For enterococci, survival is only affected at a temperature of 25 °C, where the number of enterococci decreases as low as the detection limit. A decrease in survival at higher temperatures probably results from an increased competition with soil micro-organisms and predation by protozoa.

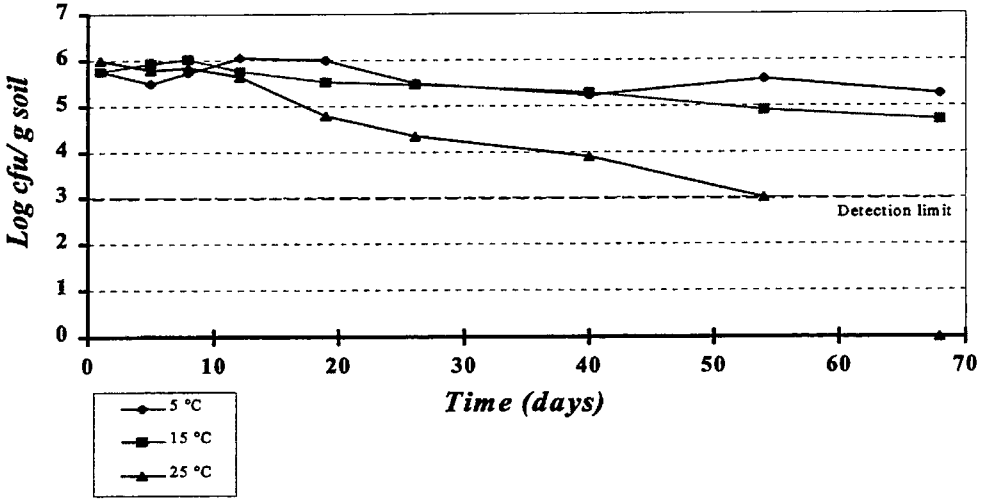

Figure 3a  
Survival of *Enterococcus* spp at different temperature levels (topsoil)

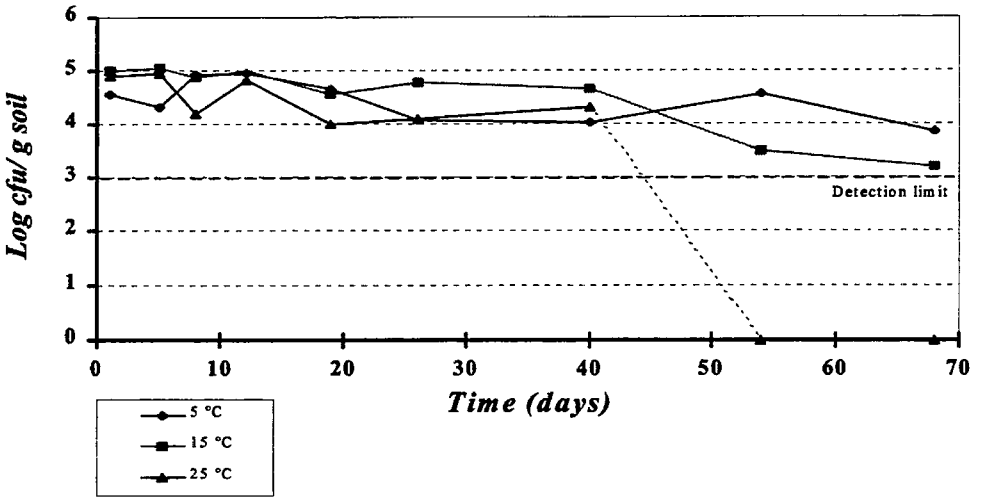

Figure 3b  
Survival of *E. coli* at different temperature levels (topsoil)

When manure is applied on the surface of the soil core instead of incorporating it into the soil, almost no infiltration of pathogens into deeper layers occurs. In the manure layer, a good survival of both species is observed (figure 4).



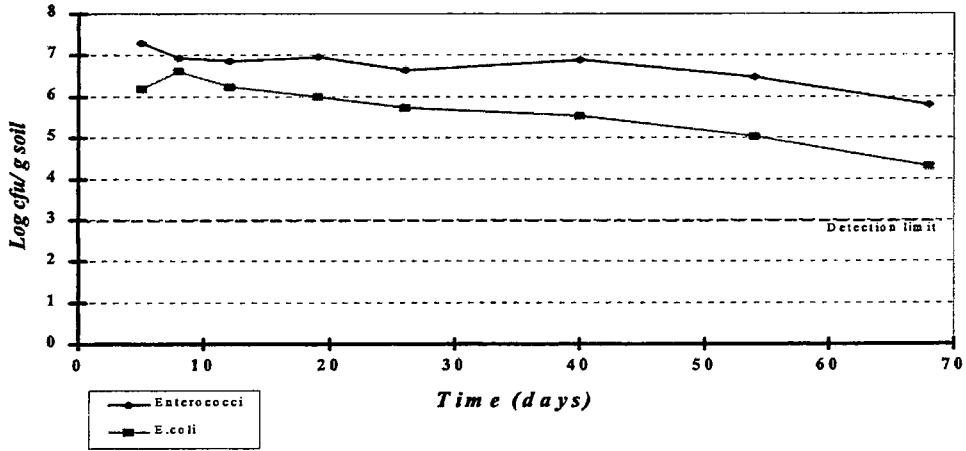

Figure 4  
Survival of *Enterococcus* spp and *E. coli* in manure on the soil surface

Figure 5 presents the survival of *E. coli* and *Enterococcus* spp at different manure application rates. Since the manure was enriched with an amount of *E. coli*, the initial number of *E. coli* is the same for all treatments.

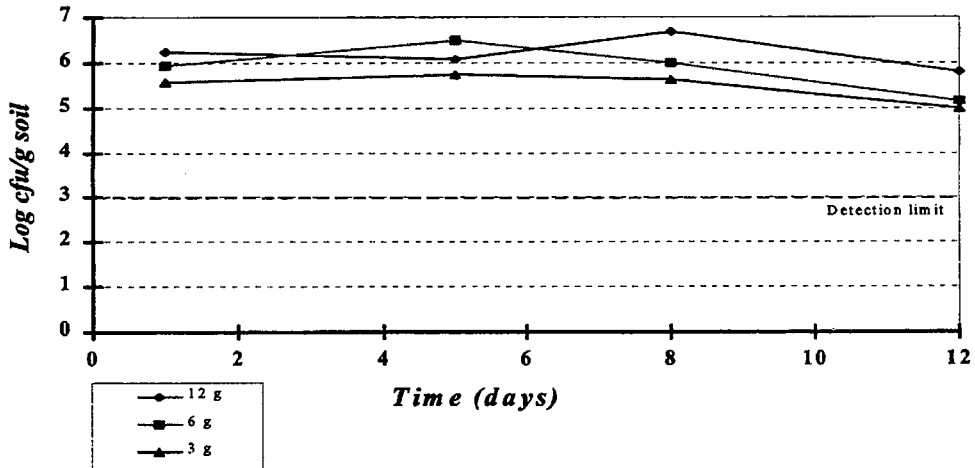
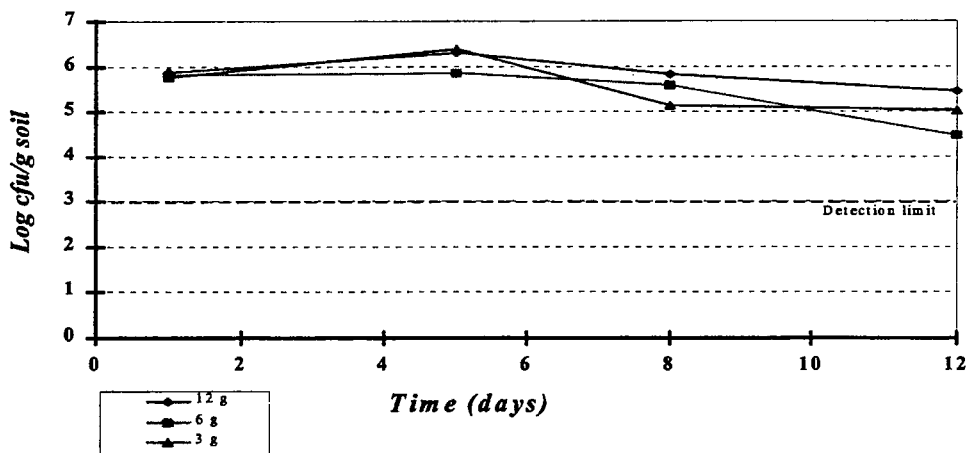

Figure 5a  
Survival of *Enterococcus* spp at different manure application rates



**Figure 5b**  
**Survival of *E. coli* at different manure application rates**

Statistical analysis (2-factor ANOVA) of the results indicates that application rate as well as time affect the survival of both species. The main results are presented in table 1.

a. Factor time : For enterococci, survival does not differ during the first 8 days, but at day 12, a different bacterial number was observed. For *E. coli*, sampling data of day 1 and 5, day 5 and 8, and day 8 and 12 do not differ. This means that growth on day 1 differs only significantly from day 8 and 12, even as growth on day 5 differs only from day 12. In other words one can state that over a longer time period, the survival of *E. coli* and *Enterococcus* spp decreases significantly in comparison with the initial bacterial count.

b. Factor dose : Growth of enterococci is significantly different at each manure dose, while for *E. coli* growth is the same at a dose of 6 g and 3 g.

	Factor TIME				Factor DOSE	
	Enterococci	E. coli			Enterococci	E. coli
Day 1	A	A		12 g	A	A
	A	A				
Day 5	A	A	B	6 g	B	B
	A		B			B
Day 8	A	C	B	3 g	C	B
		C				
Day 12	B	C				

*Table 1*  
Main results of 2-factor ANOVA

Factor levels with the same letter are not significantly different

## 4. Conclusion

**4.1.** Preliminary results of survival experiments of fecal bacteria in soil indicate that both species survive well over a period of 68 days. *Enterococcus* spp survive better than *E. coli* and bacteria in topsoil show a prolonged survival compared to bacteria in subsoil.

**4.2.** Moisture content does not affect the survival of either species. Increasing temperature levels cause a decreasing survival of *E. coli* at 15 °C and 25 °C, of *Enterococcus* spp only at 25 °C. Both species survive well in a manure layer applied on the soil surface. Also the manure application rate has an influence on bacterial growth.

## 5. Acknowledgments

This research was made possible through a Ph.D. grant from the Flemish Institute for the Advancement of Scientific and Technological Research in Industry (IWT).

## 6. References

- Aalbaek B., Rasmussen J., Nielsen B., Emerdahl Olsen J.** (1991) Prevalence of antibiotic-resistant *Escherichia coli* on Danish pigs and cattle. *APMIS* 99, 1103-1110
- Bager F., Madsen M., Christensen J., Aarestrup F.** (1997) Avoparcin used as a growth promoter is associated with the occurrence of vancomycin-resistant *Enterococcus faecium* on Danish poultry and pig farms. *Preventive Veterinary Medicine*, 31, 95-112

**Corpet D.** (1996) Microbiological hazards for humans of antimicrobial growth promoter use in animal production. *Revue Méd. Vét.*, 147 : 12, 851-862

**Donnelly J., Stentiford E.** (1997) The *Cryptosporidium* problem in water and food supplies. *Lebensm.-Wiss.u.-Technol.*, 30, 111-120

**Shah P.M., Schäfer V., Knothe H.** (1993) Medical and veterinary use of antimicrobial agents : implications for public health. A clinician's view on antimicrobial resistance. *Veterinary Microbiology*, 35, 269-274

**Sundlof S.** (1997) Historical perspective on the public health risks associated with antibiotic use in food producing animals. WHO, electronic discussion forum, Sept. 1997

# **Environmental impact of NPK-fertiliser versus anaerobic digestion residue or compost - A systems analysis**

*Impact environnemental de l'utilisation d'engrais chimiques N-P-K comparativement aux résidus issus de digestion anaérobie ou de compostage : un système d'analyse*

## **M. I. Dalemo**

Swedish Institute of Agricultural Engineering, P.O.Box 7033, S-750 07 Uppsala, Sweden

E-mail : magnus.dalemo@jti.slu.se

## **Anna E. Björklund**

Dept. of Chemical Engineering and Technology/Industrial Ecology, Royal Institute of Technology, S-100 44 Stockholm, Sweden

## **Ulf G. Sonesson**

Dept. of Agricultural Engineering, Swedish University of Agricultural Sciences, P.O.Box 7033, S-750 07 Uppsala, Sweden

## **Abstract**

*A systems analysis approach was used to evaluate the environmental impact of four different fertilising alternatives in agriculture. Three scenarios with emphasis on recycling of nutrients from waste were evaluated against the most common situation when mineral fertiliser is used. The study was carried out for a large Swedish city. Activities studied were production of mineral fertiliser, waste treatment, production of electricity and heat, transportation and utilisation of nutrients in soil. Waste fractions included in the study were biodegradable household and industrial waste, slurry manure from cows and pigs, and sewage sludge.*

Keywords: *Systems analysis, Environmental impact, Organic fertiliser*

## **Résumé**

Une approche par système d'analyse a été utilisée pour évaluer l'impact environnemental de quatre fertilisants potentiels utilisés en agriculture. Trois scénarios insistant sur le recyclage des éléments nutritifs des résidus ont été comparés à celui plus conventionnel utilisant des engrais chimiques. L'étude a été réalisée pour une grande agglomération suédoise. Les activités étudiées concernaient la production de fertilisants minéraux, le traitement des déchets, la production d'électricité et de chaleur, le transport et l'utilisation des éléments par le sol. Les fractions de déchets associés à cette étude étaient des résidus ménagers biodégradables, des déchets industriels, des déjections animales bovines et porcines et des boues de stations d'épuration.

Mots-clés : systèmes d'analyses, impact environnemental, fertilisant organique.

## **1. Introduction**

The most commonly used systems for disposal of solid organic waste are collection of the waste mixed with other fractions and treating it by incineration or landfilling. Landfilling of organic wastes decreases in Europe, and will probably not be permitted in the future. However, source separating of the organic waste fractions and treatment in a composting or anaerobic digestion plant is becoming more widespread. The intention is to decrease the environmental impact and to facilitate return of nitrogen and phosphorus to farmland. The return of nutrients implies transportation and spreading of treatment residues. However, due to the complexity of the waste handling system there is an obvious risk of introducing systems that reduce the environmental impact from one part of the system, while increasing the impact from other parts. Therefore, the aim of this study was to compare production and use of organic fertiliser with use of mineral fertiliser and traditional waste management from a systems perspective.

The biodegradable waste from an entire municipality with 190 000 inhabitants, is included in the study together with slurry manure produced in the surroundings. A more detailed description of the study can be found in Dalemo et al. (1998).

## **2. Method**

A simulation model ORWARE is used for calculation of material flows, emissions and energy turnover. Life-cycle assessment (LCA) techniques are adopted to choose system boundaries, functional units and for evaluation (Lindfors et al., 1995).

### **Simulation model**

The impacts of waste management are calculated using a computer model called ORWARE (ORganic WAste REsearch model. Dalemo et al., 1997). The model calculates energy flows, plant nutrient flows and emissions to air, water and soil in detail. It is a mathematical (non-linear) static model, implemented in MATLAB/Simulink (Maths Works Inc., 1997). All process sub-models are based on the same structure. Consumption of energy and resources, production of energy, emissions to air and water, and residual effluent are related to the quantity and composition of the material flow to the process (Figure 1).

### **System boundaries**

The model calculates emissions and flows of energy and nutrients from solid and liquid organic waste. The comparisons of treatment methods are valid for plants with a high technical standard regarding environmental impact prevention. Only direct emissions from the handling of organic waste are included. For example, emissions produced when constructing infrastructure and buildings are not included.

Activities dealt with in the model include the collection and transport of waste fractions, treatment of waste and the recirculation or final disposal of residues. The recirculation of organic fertilisers includes transport, spreading operations on farmland, and increased nutrient emissions when using organic fertilisers on farmland in comparison with mineral fertilisers. Environmental impacts from landfilling of material are divided into time frames representing surveyable time (within ca 100 years) and a long-term perspective, corresponding to complete spreading of landfilled material. The long-term emissions are potential worst case emissions and presented separately.

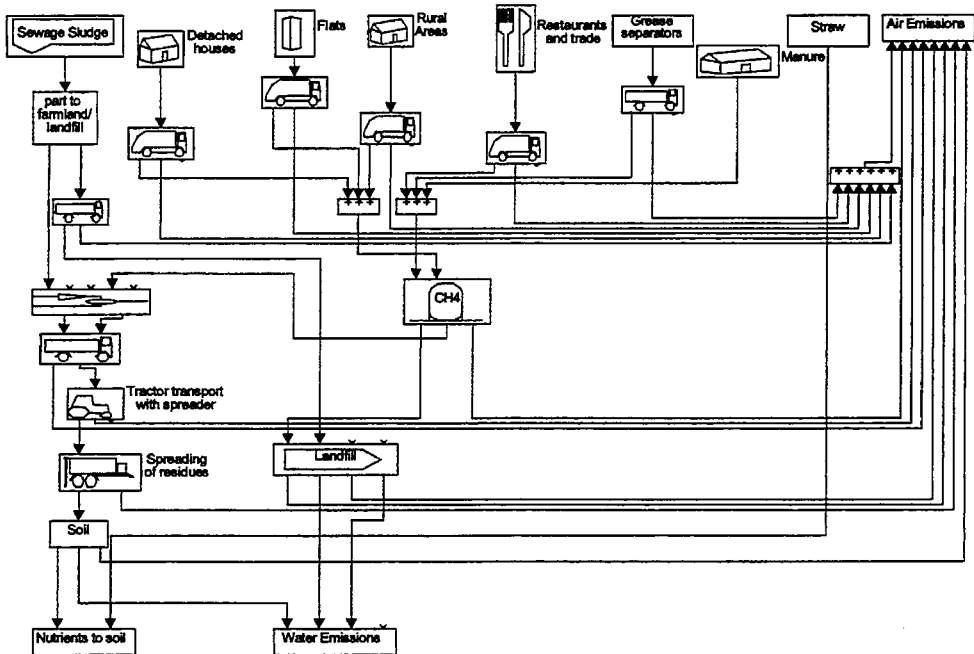

*Figure 1.*  
*The anaerobic digestion scenario, an example of the model picture in the Matlab/Simulink program*

### **Waste fractions**

The total quantity of biodegradable waste included in the study is about 63 000 tonnes generated during one year. Approximately 25 % is from sewage sludge, 30 % from other municipal waste sources and 40 % from slurry manure. The remaining 5 % consists of straw needed in the windrow composting scenario (table 1).

	Sludge	Block of flats	Single houses	Rural houses	Trade	Restau- rants	Grease water	Cow manure	Pig manure	Straw
Dry matter	3 900	2 161	1 593	801	150	550	108	1 512	288	2 550
Wet weight	16 250	6 175	4 550	2 288	500	2 200	3 000	21 600	3 200	3 000
Total N	152	43.2	31.9	16.0	2.3	12.1	0.1	84.7	17.0	12.8
Total P	137	8.2	6.1	3.0	0.8	0.6	0.1	18.1	4.6	1.8

Table 1.

*Waste quantities included in the study of a large city region, and their contents of nitrogen and phosphorus (metric tonnes per year)*

## Scenarios

Four scenarios are compared in this study. In all scenarios half of the sewage sludge is used as organic fertiliser on farmland and half is landfilled. Of special focus in the study is the influence of nitrogen emissions. A simplified model is used. Increased emissions of  $N_2O$  are related to the losses of nitrogen (1.25 % of the losses), the  $NO_3$  and  $N_2$  to the content of organic-bound nitrogen (35 % respectively), and the  $NH_3$  to the ammonium content (15 %) in the organic fertilisers. A brief description of the calculation conditions in the scenarios is made below.

*Mineral fertiliser scenario.* All urban waste is incinerated except the grease water which is landfilled together with ashes from the incineration process. The incineration plant mirrors the waste incineration facility in Uppsala, with a capacity of 250 000 tonnes/year. It is equipped with flue gas condensation and cleaning. This includes dust removal,  $NO_x$ -reduction and dry removal of acid gases. Heat is recovered for district heating. The leachate from landfill is treated for removal of phosphorus and nitrogen. 50 % of the landfill gas is collected and burned in a gas engine, generating heat and electricity. Slurry manure is transported from farms and spread on arable land without any treatment. Half of the sewage sludge is used as organic fertiliser on farmland and the other half is landfilled. Straw is left on farmland. Production and use of nitrogen and phosphorus mineral fertiliser is included

*Anaerobic digestion residue scenario.* Urban and agricultural wastes are treated in an anaerobic digestion plant. The manure is transported with the same truck as the residue transport. The anaerobic digestion plant includes hygienisation (70°C) of the waste. The digester is a continuous, single stage, mixed tank reactor (C.S.T.R.) operating under mesophilic temperature. Heat exchanger is included, reducing heat consumption for hygienisation. The gas is used for production of electricity and heat in a stationary engine. Half of the sewage sludge is used as organic fertiliser on farmland and half is landfilled. Straw is left on farmland.

*Reactor compost scenario.* Urban waste is composted in a reactor composting plant. The reactor compost facility is a rotating drum, followed by maturing in the open air with controlled aeration. The exhausted gas equipment consists first of a condensation step and thereafter a biofilter. Slurry manure is transported from farms and spread on arable land without any treatment. Half of the sewage sludge



is used as organic fertiliser on farmland and half is landfilled. Some production and use of nitrogen fertiliser is included.

*Windrow compost scenario.* Urban waste is composted in a reactor composting plant, except the grease water which is landfilled due to the low dry matter content. The straw is used as amendment in the composting process. Slurry manure is transported from farms and spread on arable land without any treatment. Half of the sewage sludge is used as organic fertiliser on farmland and half is landfilled. The windrow compost facility is an open-air compost with forced aeration but without equipment for exhaust gas purification. Some production and use of nitrogen fertiliser is included.

### Functional units

System boundaries and functional units are chosen to make all scenarios comparable with respect to nutrients supplied to growing crops, the amount of waste treated, and the provision of district heating and electricity. The anaerobic digestion scenario results in the largest quantity of nutrients from organic fertilisers (170 tonnes N and 111 tonnes P), as anaerobic digestion residue and sewage sludge. In the other scenarios production of mineral fertiliser is included in a quantity so that these scenarios result in the same amount of nitrogen and phosphorus available to crops. With the same principle, heat production from wood chips and electricity production from oil are included in the scenarios in quantities so that all scenarios produce the same net amount of heat and electricity. The largest production of heat from waste is found in the mineral fertiliser scenario (77 TJ), and the largest production of electricity is found in the anaerobic digestion scenario (17 TJ).

### Evaluation

The emissions are aggregated in environmental impact categories (Table 2). The impact categories presented are global warming potential, acidification and eutrophication. One reason for choosing only these categories is that the weighting factors for these categories are relatively well-defined. Weighting factors for human health and ecotoxicity are more uncertain, and there is a wide range of methods for aggregating these categories. However, results from these impact categories can be found in Dalemo et al. (1998). Furthermore, the use of resources in the scenarios are not presented in this paper.

Global warming potential [CO <sub>2</sub> -equivalents]		Eutrophication [O <sub>2</sub> -equivalents]		Acidification [kmol H <sup>+</sup> ]	
CO <sub>2</sub> -f	1	NO <sub>x</sub>	6	SO <sub>2</sub>	0.031
CH <sub>4</sub>	24.5	NH <sub>3</sub>	16	HCl	0.027
N <sub>2</sub> O	320	NH <sub>4</sub>	15	NO <sub>x</sub>	0.022
		NO <sub>3</sub>	4.4	NH <sub>3</sub>	0.059
		P	140		
		COD	1		

Table 2.

*Weighting factors used for evaluation of environmental impact (Lindfors et al., 1995)*

The three categories studied cover many of the important environmental impacts from waste management. Global warming reflects the consumption of non-renewable energy sources. CH<sub>4</sub> emissions from organic waste and N<sub>2</sub>O emissions from farmland are also important sources for global warming impact. Reducing eutrophication is an important reason for introducing new waste management systems and also for introducing anaerobic digestion of manure. Acidification reflects the emissions of NO<sub>x</sub> and SO<sub>2</sub> from transport and energy utilisation, and also the increased emissions of NH<sub>3</sub> when using organic fertilisers instead of mineral fertiliser.

Economic considerations are also necessary to find systems capable of reducing the environmental impact at reasonable cost. It is also often possible to reduce a specific substance with purification technology but this will also influence the costs.

### **3. Results**

The results indicate that the anaerobic digestion residue scenario is preferable regarding global warming and eutrophication, while the mineral fertiliser is preferable when studying the acidification effect. Urban/agricultural waste treatment has a large impact in all categories (Table 3). The substances and processes contributing to the different categories vary between scenarios. This is discussed separately below. Electricity production has a large impact, primarily on the global warming category, since the energy source is oil and therefore results in emissions of CO<sub>2</sub> from fossil origin. Environmental impacts from heat production from wood chips are emissions of NO<sub>x</sub> and SO<sub>2</sub>, contributing to acidification. Phosphorus production has only a minor impact in all categories. Natural gas is the source for production of nitrogen fertiliser, which therefore results in CO<sub>2</sub> emissions contributing to global warming. The long-term emissions influence the global warming with emissions of CH<sub>4</sub> and eutrophication with emissions of P to water. Including these uncertain future emissions makes the mineral fertiliser scenario worse depending on the landfilling of ashes from incineration

	Urban/ agricultural waste management	Electricity production	Heat production	Phosphorus production	Nitrogen production	Long-term emissions from landfilling	Total
<i>Global warming potential (tonnes of CO<sub>2</sub>- equivalents)</i>							
Mineral fertiliser	2435	1847	0	39	693	1633	6647
Anaerobic d.residue	1852	0	0	0	0	351	2203
Reactor compost	2373	1570	0	0	416	355	4714
Windrow compost	4038	1475	0	0	560	397	6471
<i>Eutrophication (tonnes of O<sub>2</sub>- equivalents)</i>							
Mineral fertiliser	2141	11	0	1	11	11436	13600
Anaerobic d.residue	1983	0	20	0	0	9414	11417
Reactor compost	2233	10	35	0	7	9416	11700
Windrow compost	2497	9	34	0	9	9355	11904
<i>Acidification (kmol H<sup>+</sup>)</i>							
Mineral fertiliser	1095	78	0	15	40	3	1232
Anaerobic d.residue	2982	0	128	0	0	3	3112
Reactor compost	1205	66	216	0	24	3	1515
Windrow compost	2844	62	213	0	33	3	3154

**Table 3.**  
Total contribution to global warming, eutrophication and acidification from the four scenarios

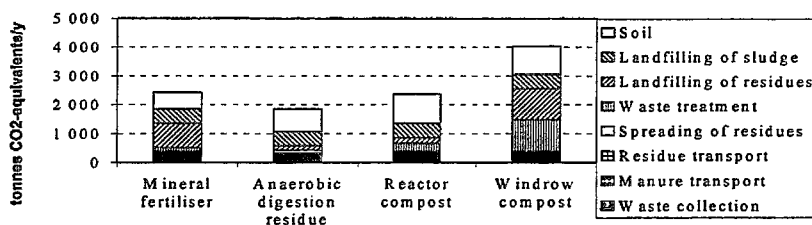

**Figure 2.**  
Global warming potential from urban/agricultural waste management.

Soil contributes to global warming by emissions of N<sub>2</sub>O. The emissions of N<sub>2</sub>O are related to the total dosage of nitrogen. The composting scenarios with largest amount of organic bound nitrogen have the largest nitrogen losses and therefore largest emissions of N<sub>2</sub>O (Figure 2). In all scenarios half of the sludge quantity is landfilled and contributes with CH<sub>4</sub> emissions. In both the mineral fertiliser scenario and windrow composting scenario, grease water is landfilled, thus resulting in CH<sub>4</sub> emissions. Emissions from main treatment processes are low except for the windrow compost emitting N<sub>2</sub>O and CH<sub>4</sub>. Transport and spreading result in CO<sub>2</sub> emissions in all scenarios.

The major eutrophication effects of waste management are from emissions of NH<sub>3</sub> and NO<sub>3</sub><sup>-</sup> from soil. Emission of NO<sub>3</sub><sup>-</sup> from organic-bound nitrogen is the dominating part and represents 80 % of the eutrophication effect from soil in the mineral fertiliser scenario, 68 % in the anaerobic digestion scenario and 88 % in the compost scenarios. The emissions from waste treatment in the mineral fertiliser scenario are P to water from water used in the incinerator's gas purification

process. The treatment in windrow compost causes eutrophication through emissions of  $\text{NH}_3$ . Other activities have low impact on the eutrophication effect.

Gases contributing to the acidification effect from waste management originate primarily from soil and treatment processes. The acidifying emission from soil is  $\text{NH}_3$ . The anaerobic digestion scenario has the largest  $\text{NH}_3$  emissions due to a high proportion of  $\text{NH}_4^+$  in digestion residue. The mineral fertiliser and anaerobic digestion residue scenarios emit mainly  $\text{NO}_x$  and  $\text{SO}_2$ . Acidifying emissions from the composting treatment processes primarily consist of  $\text{NH}_3$ .

The economic calculations consider the overall costs of the four waste management strategies. This includes costs for collection and treatment as well as costs for mineral fertiliser and revenue from energy. The total costs are almost similar, but in the mineral fertiliser and anaerobic digestion scenarios the revenue from energy results in a lower net cost for these scenarios (Figure 5). The markets for heat from incineration and heat and electricity from anaerobic digestion are therefore important issues in these scenarios. The transportation of waste has a much larger influence on the economic calculations than on the environmental impact. The costs for mineral fertiliser are low in relation to other costs also in the mineral fertiliser scenario.

## **4. Conclusions**

**4.1.** None of the scenarios are best in all of the environmental impact categories studied. The anaerobic digestion residue scenario has the lowest emissions of global warming, while the mineral fertiliser scenario and reactor composting scenario have the lowest for acidification.

**4.2.** The largest contribution to the global warming effect in this study comes from electricity production ( $\text{CO}_2$ ), landfilling ( $\text{CH}_4$ ) and soil ( $\text{N}_2\text{O}$ ).

**4.3.** The eutrophication effect is dominated by long-term emissions of phosphorus from landfilling. The largest immediate emissions are  $\text{NO}_3^-$  and  $\text{NH}_3$  from soil.

**4.4.** Important sources for acidification are  $\text{NH}_3$  from soil,  $\text{NH}_3$  from the composting process in the windrow composting scenario, and  $\text{NO}_x$  and  $\text{SO}_2$  from burning the gas in the anaerobic digestion residue scenario.

**4.5.** Emissions from soil have a large impact on the results for all categories. Parameters influencing these emissions have to be studied further.

**4.6.** From both environmental and economic views, the emissions and costs arising from production of mineral fertilisers have a minor influence on the results of the studied system.

## **5. Acknowledgements**

We wish to thank Hydro Agri Europe for financially supporting this study.

## **6. References**

**Dalemo M., Sonesson U., Björklund A., Mingarini K., Frostell B., Jönsson H., Nybrant T., Sundqvist J-O. & Thyselius L., (1997) ORWARE - A simulation model for Organic Waste Handling Systems, Part 1: Model Description, *Resources, Conservation and Recycling vol. 21 pp. 17-37.***

**Lindfors L-G., Christiansen K., Hoffman L., Virtanen Y., Juntilla V., Hanssen O-J., Ronning A., Ekvall T. & Finnveden G. 1995. Nordic Guidelines on Life-Cycle Assessment. Nordic Council of Ministers. Nord 1995:20. Copenhagen, Denmark.**

**Dalemo M., Björklund A., Oostra H. & Sonesson U. 1998. Systems Analysis of Nutrients Recycling from Organic Waste. Swedish Institute of Agricultural Engineering. JTI report, Kretslopp & avfall nr. 15. Uppsala, Sweden.**

**Maths Works Inc. Simulink User's Guide. Natick, Massachusetts. 1997.**



## **Yield effect and utilization of nitrogen from solid manure**

*Effet sur le rendement et utilisation de l'azote de déjections animales solides.*

**Ulrich Walther and Ulrich Herter**

Swiss Federal Research Station for Agroecology and Agriculture  
Reckenholz, CH-8046 Zürich. Switzerland.  
E-mail : ulrich.herter@fal.admin.ch

### **Abstract**

*We calculated agronomic and ecological characteristics for fertilization with two types of solid cattle manure in a long-term trial in Oensingen, Switzerland. With a manure dose of 30 t/ha, the mean yield effect of manure nitrogen was 12% of the effect of ammonium nitrate: 15% for composted and 9% for stacked manure. The mean utilization of manure nitrogen was 15% for composted manure and 8% for stacked manure. Utilization was highest when manure was combined with a low mineral nitrogen application. Time of manure application had no consistent effect on utilization, but spring application had a greater effect on yield than fall application. The generally low utilization of manure nitrogen may have been caused by the heavy soil.*

Keywords: *solid manure, nitrogen, nitrogen utilization, soil-type.*

### **Résumé**

Nous avons calculé les caractéristiques agronomiques et écologiques liées à la fertilisation avec deux types de déjections bovines solides lors d'un essai de longue durée à Oensingen, en Suisse.

Avec une dose de déjections de 30 t/ha, l'effet moyen sur le rendement de l'azote des déjections, comparativement à un engrais chimique (nitrate d'ammonium) est de 12% : 15% pour le compost et 9% pour le fumier en tas. L'utilisation moyenne de l'azote des déjections s'établit à 15% pour le produit composté et à 8% pour le fumier en tas. L'utilisation est améliorée lorsqu'une dose d'engrais est combinée à l'apport de déjections. La date d'apport n'a que peu d'effet sur l'utilisation, mais les épandages de printemps ont un meilleur effet sur le rendement que les épandages d'automne. Cette relativement faible utilisation des déjections animales est peut être due au sol utilisé ici qui est un sol lourd.

Mots-clés : déjections solides, azote, utilisation azote, type de sol.

## **1. Introduction**

The role of solid manure in plant nutrition with nitrogen (N) is often debated. Different experiments have shown a relatively low and variable utilization of the N in solid manure.

Maillard and Vez (1984) reported that in a 19-year trial solid manure did not have a significant yield effect when applied together with 70 kg mineral N per ha and year. However, the mineral N level of the soil in this experiment may have been close to the optimum already without manure. The same authors reported on an experiment where a chisel and a moldboard plow were used for superficial and deep incorporation of manure (Maillard and Vez, 1991). With a chisel plow the yield was significantly (12%) increased due to manure, but not with the moldboard plow. Boguslawski (1988) determined a mean yield increase due to manure of more than 40% for sugar beets, wheat and oats (mean of 27 years; 20 t manure per ha and year; no mineral N, P and K). However, it is not evident if part of the increase is due to lack of P and K in the control treatment.

The effect of manure on water quality has been studied more closely in recent years. Benoit (1994) reported that manure application increased the nitrate leaching potential for cropland compared to mineral N application. In that study, water samples were taken with porous cups below the root zone for analysis of the nitrate content.

It is important to determine more closely the factors which affect the utilization of manure-N in order to maximize the utilization and minimize N-loss into the atmosphere and groundwater. We started a project in 1986 to evaluate the effect of crop, application time, manure storage, manure quantity and the combination of manure with mineral N-fertilizer on the utilization of manure-N.

## **2. Description of the experiment**

The experiment was started in 1986 in Oensingen (between Bern and Basel), Switzerland, on clayey loam with 39% clay, 37% silt and 2.4% organic C. The crop rotation was maize - winter wheat/catch crop - potatoes - winter barley/catch crop. A rape and oats mixture was used as catch crop. In the 12 years of this experiment, each of the four main crops was planted three times, the catch crop six times.

All 120 plots of 4.5 m x 10 m were planted with the same crop in a split-split-plot design to investigate 4 factors in 30 treatments with 4 replications (Table 1). The factors were application time (fall and spring), manure type (composted and stacked), manure quantity, and level of mineral N-application.



Factor	Treatment	Code
Manure application time	Spring fall	
Manure type and quantity	no manure	M0
	30 t/ha composted m.	CM30
	60 t/ha composted m.	CM60
	30 t/ha stacked m.	SM30
	60 t/ha stacked m.	SM60
Levels of mineral N application *	No mineral N	N0
	ca.60% of optimum	N1
	optimum	N2

\* Mean mineral N applied per ha and year : N0 : 0 kg ; N1 : 79 kg, N2 : 134 kg.

\*\* Main plot is application time, split plot is manure type and quantity, split-split plot is mineral N-level.

*Table 1*

*Description of the treatments (Factorial design with 2x5x3 treatments\*\*).*

Manure was stored for 3.5-4.5 months before application and the manure to be composted was turned once using a manure spreader. Weight loss during composting was about 35% for composted and 15% for stacked manure (% of original weight), N-loss was 33 and 13%, respectively, as described by Besson (1991). Manure was applied in fixed amounts of 30 or 60 t/ha (fresh weight).

N-contents of manure are presented in Table 2. Application doses and N-contents are valid for manure at application time. The manure was applied only to maize and potatoes with a manure spreader and the plots were plowed at about 25 cm depth immediately thereafter.

Manure type	Organic N kg/Nt		Ammonium-N kg N/t		Total N kg N/t	
	mean	range	mean	range	mean	range
Composted manure	3.7	2.7-5.1	0.22	0.15-0.40	3.9	2.9-5.5
Stacked manure	3.1	2.7-3.9	0.71	0.62-0.92	3.8	3.4-4.6

*Table 2*

*Nitrogen content of the manure used in the trial.  
(Values are expressed per ton manure, fresh weight).*

The mineral N content of the soil was measured in spring to determine the amount of mineral N to be applied. The optimum quantity of N (treatment N2) was determined according to Swiss fertilization standards (Walther et al. 1994), the low quantity (N1) was set at 55-65% of the optimum. Mineral P and K fertilizers were applied on all plots according to soil tests and Swiss fertilization standards.

Yield and dry matter of the crop was determined and the N-content of the harvested crops was analyzed (one analysis per treatment) to calculate the N-utilization by the plants. The main crop yields include potato tubers (fresh weight) and grain of the other crops (with 15% H<sub>2</sub>O). For the calculation of N-utilization, we included N-contents of potato tubers, grain and straw of small grains and whole plants of maize.

The yield effect of mineral N is expressed as kg additional yield per kg N applied. It is determined by comparing yields of the mineral treatments without manure and the zero-N treatment (example: comparison of yields of M0/N2 and M0/N0; codes see Table 1). The yield effect of manure-N was determined as additional yield compared with the zero-manure treatment of the same mineral N-level (example: CM30/N2 and M0/N2). Finally, a relative yield effect of manure-N was calculated (yield effect of mineral N = 100%).

Utilization of N was expressed as additional N-uptake by crops per kg N applied. It was calculated based on the difference between treatments as presented above for yield effect.

These calculations are based on the assumption that mineral N was utilized to the same degree in the treatments with and without manure and had the same yield effect in both treatments.

### 3. Results and discussion

Manure treatment	Mineral N level	Mean mineral N application (kg/ha per year)				
		Maize	Wheat	Potatoes	Barley	Mean
all	N1	93	77	70	75	79
all	N2	147	143	122	125	134

*Table 3  
Mean mineral N application per crop.*

Manure treatment	Mineral N level	Yield of main product (dt/ha per year ; potatoes : fresh tubers ; others : grain at 15% H <sub>2</sub> O).			
		Maize	Wheat	Potatoes	Barley
M0	N0	58.2	31.9	226.5	42.4
M0	N1	77.1	50.9	316.9	70.3
M0	N2	88.5	61.9	361.6	72.6
CM30/SM30	N0	60.9	33.8	247.1	47.6
CM30/SM30	N1	82.0	54.0	347.8	72.1
CM30/SM30	N2	91.3	63.7	387.0	71.8
M0	N0/N1/N2	74.6	48.2	301.6	61.8
CM30/SM30	N0/N1/N2	78.1	50.5	327.3	63.8

*Table 4  
Mean yield per crop without and with manure and mineral fertilizers.*

Table 3 presents the mean mineral N-application per crop and N-level, Table 4 the yields for the treatments with to manure and with 30 t manure per hectare at the three mineral N levels. The results indicate that yields are mainly influenced by the mineral N level.

This can also be seen in Table 5, where yield effects are presented as additional kg yield per kg N from mineral fertilizer and manure. The results are presented in

more detail for 30 t than for 60 t/ha because 60 t/ha have to be considered beyond good practice (increased risk of N-leaching).

Manure treatment	Mineral N level	Yield effect of	Additional yield of main product (kg/kg N; potatoes: fresh tubers; others: grain at 15% $H_2O$ )			
			Maize	Wheat	Potatoes	Barley
M0	N1	mineral N*	20.0	24.2	158.0	37.4
M0	N2	mineral N*	20.4	20.2	129.4	24.2
CM30/SM30	N0/N1/N2	manure-N**	3.4	2.6	19.5	1.8

\* Additional yield compared with N0-treatment, expressed per kg mineral N applied

\*\* Additional yield compared with zero-manure-treatments, expressed per kg N NNNtotal in manure (manure application: 30 t/ha).

*Table 5.*  
*Mean yield effect per kg N from mineral fertilizer or manure*

The relative yield effect of 30 t/ha manure is presented in Table 6 and expressed as percent of the yield effect of ammonium-nitrate. These values allow to compare treatments across different crops. The mean relative yield effect was 15% for composted manure and 8.9% for stacked manure, resulting in an overall mean of 11.9%. The effect was only 7.4% when 60 t/ha were applied. Highest yield increase was reached with manure applied in spring to maize at the low mineral N-level (38 to 41%), lowest values were reached for barley at the N2-level (-3.3 to 1.7%). Composted manure almost consistently had higher yield effects than stacked manure when applied in spring. This difference was less constant for fall application.

Manure Treatment	Mineral N	Relative yield effect of manure-N (yield effect of mineral N=100)					Relative yield effect of manure-N (yield effect of mineral N=100)					Mean : fall and spring, all crops
		Fall application of manure					Spring application of manure					
		Maize	Wheat	Potatoes	Barley*	Mean	Maize	Wheat	Potatoes	Barley*	Mean	
CM30	N0	33.9	15.3	16.9	15.7	20.4	16.9	11.7	16.7	12.7	14.5	17.5
SM30	N0	-4.4	-4.6	1.1	4.4	-0.9	5.0	12.8	4.3	13.6	8.9	4.0
CM30	N1	9.3	5.5	3.2	2.3	5.1	41.4	24.8	25.8	4.3	24.1	14.6
SM30	N1	14.4	9.8	11.3	9.3	11.2	38.4	22.7	13.2	6.0	20.1	15.6
CM30	N2	15.7	6.8	17.0	1.7	10.3	25.0	12.8	22.7	1.5	15.5	12.9
SM30	N2	6.6	9.9	18.4	1.0	9.0	6.6	12.1	4.1	-3.3	4.9	6.9
CM30/SM30	N0	14.8	5.4	9.0	10.0	9.8	11.0	12.3	10.5	13.1	11.7	10.7
CM30/SM30	N1	11.9	7.7	7.3	5.8	8.1	39.9	23.8	19.5	5.1	22.1	15.1
CM30/SM30	N2	11.2	8.4	17.7	1.3	9.6	15.8	12.5	13.4	-0.9	10.2	9.9
CM30	N0/N1/N2	19.6	9.2	12.4	6.5	11.9	27.8	16.4	21.7	6.1	18.0	15.0
CM30	N0/N1/N2	5.5	5.0	10.3	4.9	6.4	16.7	15.9	7.2	5.4	11.3	8.9
CM30/SM30	N0/N1/N2	12.6	7.1	11.3	5.7	9.2	22.2	16.2	14.5	5.8	14.7	11.9
CM60/SM60	N0/N1/N2	7.9	3.8	4.9	4.5	5.3	12.4	12.1	6.3	7.2	9.5	7.4

\* Values for barley were calculated without data from 1989 (greater lodging than in other years).

*Table 6*  
*Relative yield effect of manure-N*

Manure treatment	Mineral N level	Utilization of manure-N (%)*		
		Fall	Spring	Mean
CM30	N0	22.7	8.3	15.5
SM30	N0	-1.7	8.1	3.2
CM30	N1	11.0	22.2	16.6
SM30	N1	11.3	15.0	13.1
CM30	N2	14.6	9.2	11.9
SM30	N2	10.2	6.1	8.2
CM30/SM30	N0	10.5	8.2	9.3
CM30/SM30	N1	11.2	18.6	14.9
CM30/SM30	N2	12.4	7.7	10.0
CM30	N0/N1/N2	16.1	13.2	14.7
SM30	N0/N1/N2	6.6	9.7	8.2
CM30/SM30	N0/N1/N2	11.4	11.5	11.4
CM60/SM60	N0/N1/N2	8.0	9.0	8.5
		Utilization of mineral N (%)		
		Fall	Spring	Mean
M0	N1	56.0	52.7	54.3
M0	N2	58.4	59.3	58.9

\* Values calculated on the base of the N-uptake of all crops (including catch crops) and N-applications over 12 years.

**Table 7**  
*Utilization of nitrogen from manure and mineral fertilizer (mean of 12 years)*

At an average, the crops utilized 56% of the mineral N applied during the 12 years: 54% at the N1-level, 59% at N2-level (Table 7). The slightly greater utilization at higher N-applications shows that applications were moderate and yields responded well at both mineral N-levels

N-uptake was added up over all 12 years and was compared with the sum of manure-N applied to get the N-utilization of manure. Mean utilization of manure-N was 11.4% with 30 t/ha and 8.5% with 60 t/ha. More detailed results are only presented for 30 t/ha. N-utilization was 14.7% for composted manure and 8.2% for stacked manure (mean over 3 mineral N-levels and 2 application times).

Manure combined with low mineral N application (N1) resulted in 14.9% N-utilization, 5-6% higher than with N0 or N2. Spring application of manure showed higher N-utilization at N1-level, fall application was better at N2-level.

N-utilization and yield effect for composted manure would be smaller if calculations were based on N present before composting. However, values would still be higher than for stacked manure.

N-utilization is also presented per crop (Table 8). These values do not show the true long-term N-utilization as described in Table 7. Because manure is applied with maize and potatoes, the utilization for wheat and barley shows only the after-effects of manure. For these two crops, utilization was calculated based on the

organic-N content of the manure in the previous year (average 88% of total N). The N from spring applied manure was utilized slightly better than from fall applied manure (5.9 versus 4.5%), but this difference was not consistent across all treatments and crops.

Mineral-N was less efficiently utilized by maize and potatoes (42-43%) than by winter wheat and winter barley (66-72%) (Table 9). This could be attributed to the late start of maize and potatoes in spring and therefore to the greater risk of N-losses (leaching and denitrification). In addition, the catch crop before maize and potatoes was removed from the plots so that mineral N left by previous crops was most likely not available any more. Finally, the low N-utilization with potatoes can partly be explained by the fact that N-uptake by leaves and shoots is not included in the calculation of N-utilization (in contrast to the other crops).

Manure treatment	Mineral N level	Utilization of manure-N by crop (%)					Utilization of manure-N by crop (%)					Mean fall and spring
		Manure application in fall					Manure application in spring					
		Maize	Wheat	Potatoes	Barley	Mean	Maize	Wheat	Potatoes	Barley	Mean	
CM30	N0	10.6	9.4	9.2	10.5	9.9	5.4	3.5	-0.6	4.6	3.2	6.6
SM30	N0	-8	-2.8	1.2	0.4	-2.3	5.7	4.5	-1.6	6.8	3.9	0.8
CM30	N1	3.2	8.1	1.3	3.4	4.0	15.6	11.6	9.1	9.6	11.5	7.7
SM30	N1	3.1	11.6	4.2	6.3	6.3	8.5	12.2	4.2	7	8.0	7.1
CM30	N2	7.3	1.8	5.7	4.2	4.8	5.7	5.9	9.9	0.3	5.5	5.1
SM30	N2	0.6	4	3	10.6	4.6	4.4	6.5	-3.2	5.9	3.4	4.0
CM30-SM30	N0	1.3	3.3	5.2	5.5	3.8	5.6	4.0	-1.1	5.7	3.5	3.7
CM30-SM30	N1	3.2	9.9	2.8	4.9	5.2	12.1	11.9	6.7	8.3	9.7	7.4
CM30-SM30	N2	4.0	2.9	4.4	7.4	4.7	5.1	6.2	3.4	3.1	4.4	4.5
CM30	N0/N1/N2	7.0	6.4	5.4	6.0	6.2	8.9	7.0	6.1	4.8	6.7	6.5
SM30	N0/N1/N2	-1.4	4.3	2.8	5.8	2.9	6.2	7.7	-0.2	6.6	5.1	4.0
CM30-SM30	N0/N1/N2	2.8	5.4	4.1	5.9	4.5	7.6	7.4	3.0	5.7	5.9	5.2

**Table 8**  
*Utilization of N from manure by different crops.*

The utilization per crop does not represent the whole utilization of manure-N, because manure was applied only every second year. See Table 7 for complete utilization of manure-N.

Manure treatment	Mineral N level	Utilization of mineral N by crop (%)				
		Maize	Wheat	Potatoes	Barley	Mean
M0	N1	40.4	60.8	41.2	73.5	53.9
M0	N2	44.9	71.4	42.5	71.2	57.5
M0	N1/N2	42.6	66.1	41.8	72.3	55.7

**Table 9**  
*Utilization of N from mineral fertilizer by different crops*

The mean utilization of manure-N per crop (with the manure dose of 30 t/ha) increased from 2.9% in the first 4 years to 4.8% in the second and 8.0% in the third rotation cycle (table 10). This can be explained by increasing after-effects of previous manure applications.

Year	Utilization of manure-N (%). Means of all treatments with 30 t manure/ha				
	Maize	Wheat	Potatoes	Barley	Mean
1986-89	-0.1	1.3	2.7	7.4	2.9
1990-93	7.4	5.6	1.6	4.6	4.8
1994-97	8.2	12.1	6.3	5.4	8.0

*Table 10*  
*Utilization of manure-N per crop during three cycles of the crop rotation*

Organic C in the soil was analyzed in several years. It did not increase during the twelve years even with the high manure dose. The total N content in the soil has not yet been analyzed. Therefore we can not yet say, how much of the almost 90% N from manure, which were not taken up by plants, are still preserved in the organic matter of the soil. The destination of the N loss (air or water) can not be estimated in this experiment.

In a long-term trial in Zurich on light soil (not published yet), mean utilization of manure-N was 20-25%, which is twice that achieved in this trial. This indicates that the soil type may play an important role and utilization is low in heavy soils.

Paul and Beauchamp (1993) determined in a three-year experiment with maize that 5% of solid manure-N were utilized by maize (grain and straw), with no significant difference between composted and stacked manure. Debruck and Boguslawski (1979) calculated in a 24-year experiment that 15% of manure-N was utilized. The experiment included sugar beets, wheat and oats with the application of 30 t of cattle manure every third year.

Experiments with solid manure have to run during several years before conclusions can be drawn. This is probably the reason why published results on this subject are rare and we do not know with certainty when to expect a poor utilization of manure-N and when a good one.

Because of the high cost of long-term experiments it is important that researchers in different countries work together on the subject of organic fertilizers. Collaboration would be desirable also when new trials are designed.

#### 4. References

- Benoit M., 1994.** Risques de pollution des eaux sous prairie et sous culture. Influence des pratiques d'apport d'engrais de ferme. *Fourrages* 140: 407-420.
- Besson J.M., 1991.** Le compostage des fumiers. *Colloq. APRIA (L'azote en question):* 29-30.1.1991. Paris.
- Boguslawski E. von, 1988.** Die Wirkung der zeitlichen Verteilung der Stallmistdüngung auf die Ertragsbildung und Faktoren der Bodenfruchtbarkeit. *VDLUFA-Schriftenreihe* 28 (2): 413-430.

**Debruck J. and Boguslawski E. von,** 1979. Die Wirkung der Kombination von organischer und mineralischer Düngung auf Grund von langjährigen Versuchen. Landwirtschaftliche Forschung (VDLUFA-Kongressband) 36: 405-429.

**Maillard A. and Vez A.,** 1984. Bilan d'un essai sans fumure organique depuis vingt ans. Revue suisse Agric. 16 (3): 135-139.

**Maillard A. and Vez A.,** 1991. Influence du travail du sol sur la valorisation des engrais de ferme et des engrais verts en grandes cultures. Revue suisse Agric. 23 (1): 11-14.

**Paul J.W. and Beauchamp E.G.,** 1993. Nitrogen availability for corn in soils amended with urea, cattle slurry, and solid and composted manures. Can. J. Soil Sci. 73: 253-266.

**Walther U., Menzi H., Ryser J.P., Fleisch R., Jeangros B., Kessler W., Maillard A., Siegenthaler A.F. and Vuilloud P.A.,**1994. Grundlagen für die Düngung im Acker- und Futterbau. Agrarforschung 1 (7, Beilage), 1-40.





# The utilization of differently treated sewage sludges in agriculture.

*Utilisation agricole de boues de station d'épuration issues de différents traitements.*

**Růzek. P., Kusá. H.**

Research Institute of Crop Production,  
Prague, Czech Republic

**Hrazdira J.**

Lhoist, Prague, Czech Republic

## Abstract

*The differently treated sewage sludges were used for pot and climabox experiments. Tested materials were liquid sludge (6.5 % of dry matter, 0.26% N in raw material), sludge after centrifugation (26.3% of dry matter, 0.84% N), composted sludge (23.5% of dry matter, 0.72% N), sludge after centrifugation with CaO (59.2% of dry matter, 0.83% N) and pelletized sludge with CaO (60% of dry matter, 0.64% N). The aim of our experiments was to evaluate the agronomical efficiency of differently treated sewage sludges and the uptake of heavy metals from treated soils by plants.*

Keywords : sludge, agriculture, lime

## Résumé

Différentes boues de station d'épuration précédemment traitées ont été utilisées lors d'essais en pots et d'une expérimentation en chambre de mesure climatisée Climabox. Les boues testées étaient, soit liquides (6.5% de matière sèche, 0.26% d'azote par rapport au produit brut), soit boues issues d'une centrifugation (26.3% MS, 0.84% N), soit boues compostées (23.5% MS, 0.72% N), soit boues après centrifugation avec ajout de CaO (59.2% MS, 0.83% N) et des boues pelletisées avec CaO (60% MS, 0.64% N). L'objectif de nos essais était d'évaluer l'efficacité agronomique de ces boues distinctement traitées et de déterminer l'absorption de métaux lourds par les plantes de sols amendés.

Mots-clés : boues, agriculture, chaux.

## 1. Introduction

At present 35 - 40% of produced sludges are utilized in agriculture in the Czech Republic. It is assumed this part of sludges will increase owing to decreased amount of landfilled ones. New legislative rules limit the direct application of sludges for agriculture, introducing both hygienic and environmental risks. These

are reasons for a pretreatment of sludges before agricultural utilization. Possible methods are as follows: composting (at the temperature above 55°C for more than 21 days, with two overdigging), fermentation in the aerobic bioreactors (at the temperature above 65°C for more than 24 hours) or lime stabilization (minimal pH = 11.5 for 1 hour at least). Sludges used in agriculture must meet limits for heavy metals and contents of certain organic substances.

## 2. Materials and methods

Differently treated sewage sludges were used for pot and climabox experiments. Tested materials were liquid sludge (6.5 % of dry matter, 0.26% N in raw material), sludge after centrifugation (26.3% of dry matter, 0.84% N), composted sludge (23.5% of dry matter, 0.72% N), sludge after centrifugation with CaO (59.2% of dry matter, 0.83% N) and pelletized sludge with CaO ( 60% of dry matter, 0.64% N).

Pot experiments with ryegrass were carried out in the Mitscherlich's pots with 5 kg of soil. Tested fertilizers were dosed to the each pot in the amount containing 2 g of nitrogen. During experiments acceptable nutrients in soil solutions were analyzed. Ryegrass yields and nitrogen contents were studied within three cuts. After the first cut soil samples were also analyzed. Nitrification and mineralization abilities and nitrate and ammonium forms of nitrogen contents were determined. Basal nitrification ability (BNA)<sup>(1)</sup> expresses the actual conditions of mineralization and nitrification processes in soil and it corresponds with the content of ammonium and slightly hydrolyzable organic nitrogen in soil which can be nitrified during a week aerobic incubation of soil wetted to 60 % of MVK (maximum water capacity) at 28 °C. Potential nitrification ability (PNA) expresses mineralization and nitrification processes in soil after slightly methabolizable nitrogen addition.

White mustard was cultivated in a climabox. The effect of applications of solid, composted and lime stabilized sludges on heavy metal contents in soils and plants and on plants growth were observed in this experiment. Tested sludges were added to 600 g of soil in the amount containing 120 and 240 mg of nitrogen. After 30 days ageing of this experiment the total content of heavy metals and their acceptable forms, which are extractable by 0.01M CaCl<sub>2</sub> or 0.005M DTPA, were determined in soils. Concentrations of total metals were also measured in plants.

Field trial has been taking place in Lukavec (eutric Cambisol, the potato production area) since 1996. Cultivated crops were potato and winter wheat in 1996 and 1997 respectively. Before potatoes these fertilizers were applied: solid sludge, sludge + CaO pelletized and manure, in such amount so that the dose of nitrogen was 150 kg per ha. Concentrations of certain elements in tested fertilizers are shown in Table 1. Soil samples were taken from all variants of our experiment. Values of pH<sub>KCl</sub>, pH<sub>H2O</sub> and NO<sub>3</sub><sup>-</sup> N, NH<sub>4</sub><sup>+</sup> N concentrations were determined.

Fertilizer	N	P	K	Ca	Mg	Pb	Cd	Zn	Cu	Cr	Ni
	(% in dry matter)					(mg/kg of dry matter)					
Solid sludge	6.0	2.6	0.6	3.8	0.3	80.0	4.8	2619	354	69	29
Sludge+CaO	1.2	0.6	0.3	36.0	0.6	14.7	1.0	523	91	14	7
Manure	2.3	0.8	3.3	1.6	0.6	6.9	1.1	120	22	14	8

*Table 1.*  
*Concentrations of elements in tested fertilizers*

### 3. Results

The pot experiment results are showed in Figures 1 - 4. Liquid sludge contained the highest amounts of nitrate and ammonium nitrogen forms, which are easily utilizable by plants. Therefore the best seedling growth (the 1st - 4th week after emergence) was observed in this variant of our experiment. Vice versa the weakest one was found in the case of sludge with CaO, where the high pH value of fertilizer affected the observed process by the negative way. The following growth was fairly intensive in the variants containing sludges which support the highest yields of ryegrass in these cases (Fig. 1). The presence of alkaline lime stabilized sludge increased the intensity of mineralization and nitrification processes in soil and the consumption of nitrogen by plants (Fig. 2, 3). Pelletized sludge with lime affected gradual calcium releasing into soil solution by the positive way (Fig. 4).

In experiments both with ryegrass and with white mustard, sludges stabilized by lime retarded the germination and emergency of plant. Owing to the short vegetation season (30 days) in a climabox a weak seedling growth became evident in the total yield of the white mustard mass, that was more inferior in the sludge-CaO variant in comparison with solid or composted sludges. The higher yield and even growth, the lower heavy metals concentration was found in plant. Concentrations of heavy metals in soils fertilized by sludges were insignificantly increased only compared to the control variant without fertilizer. In the case of soil with lime stabilized sludge lower amounts of heavy metals extractable by DTPA solution were found.

Both nutrients (N, P, K) and heavy metals concentration were decreased in finished product by the lime stabilization (Tab. 1). After mixing of sludge with CaO slaking of the latter ran thanks to water contained in sludge. Increasing of temperature of the reaction mixture, decreasing of the water content and strong increasing of pH (owing to  $\text{Ca(OH)}_2$  forming) were observed consequently. Under these alkaline conditions mobile heavy metals cations ( $\text{Cd}^{2+}$ ,  $\text{Cu}^{2+}$ ,  $\text{Ni}^{2+}$ ,  $\text{Pb}^{2+}$ ,  $\text{Zn}^{2+}$ ) form hydroxides which are only slightly soluble in water. After pelletizing the product is dried by air and influenced by the carbonatation process. By this process hydroxides in surface layers are transformed to carbonates soluble only in strongly acid solutions. Thus the protective cover arises on the surface of pellets. Following maturing of pellets (carbonatation carries on into internal layers) takes place after their defraying into dry soil. Therefore after the agricultural application of lime stabilized pelletized sludge heavy metal releasing to soil occurs only slowly and in the limited range reducing their transport into plants and a food chain.

The effect of pelletized sludge with lime was also verified by a field trial, in comparison with solid sludge, manure and soil without fertilizer. Pellets successive disintegration and nutrients releasing to soil solution took place after their application and defraying to soil. The latter improved physical and chemical properties of soil including the pH regulation in the following period (Fig. 5). Results obtained were similar to ones in the pot experiments: soil with this sludge had the higher mineralization and nitrification ability, nitrogen bonded in organic compounds both in soil and sludge was released more intensively, and therefore yields obtained for potatoes and wheat were the highest of all tested variants (Fig. 6-8).

dry mass yield (g/pot)

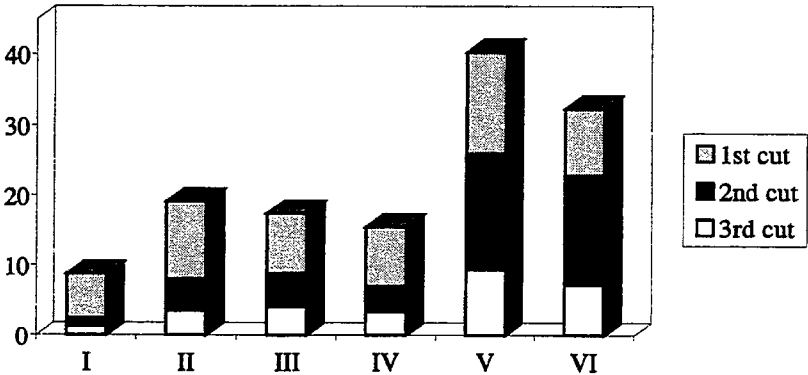

I - Control. II - Liquid sludge. III - Solid sludge. IV - Composted sludge. V - Sludge + CaO. VI - Sludge + CaO pelletized.

**Figure 1**  
Yield of ryegrass

N uptake (g N/ pot)

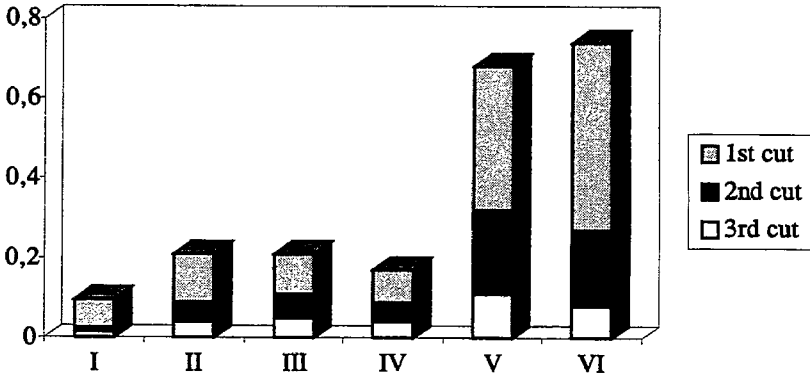

I - Control. II - Liquid sludge. III - Solid sludge. IV - Composted sludge. V - Sludge + CaO. VI - Sludge + CaO pelletized.

**Figure 2**  
Amount of nitrogen taken up by plants.

mg NO<sub>3</sub>-N/kg/day

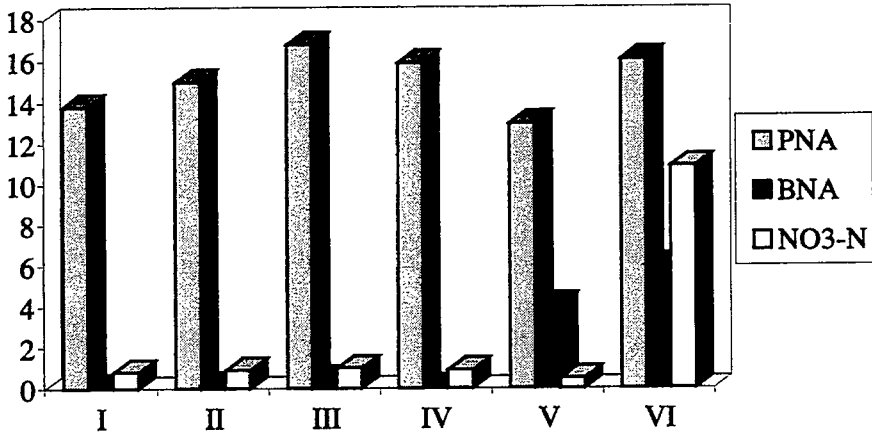

I - Control. II - Liquid sludge. III - Solid sludge. IV - Composted sludge. V - Sludge + CaO. VI - Sludge + CaO pelletized.

**Figure 3**  
Nitrate content in soil and nitrification ability of soil.

Ca (mg/l)

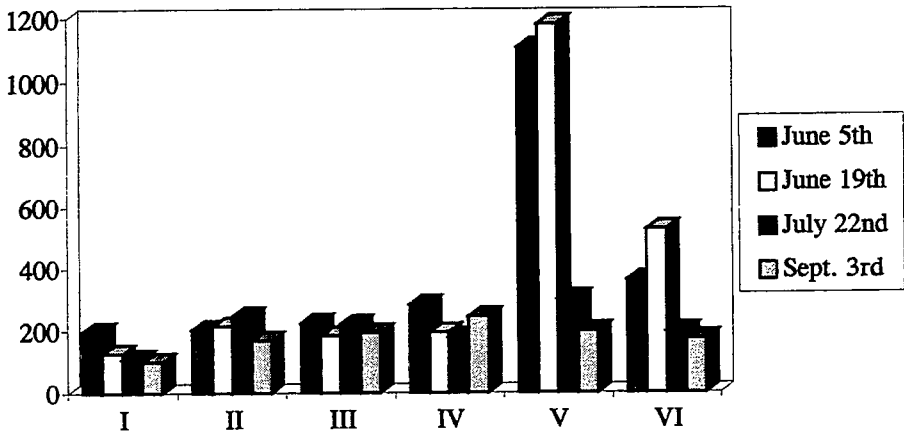

I - Control. II - Liquid sludge. III - Solid sludge. IV - Composted sludge. V - Sludge + CaO. VI - Sludge + CaO pellets.

**Figure 4**  
Calcium content in soil solution.

pH/KCl

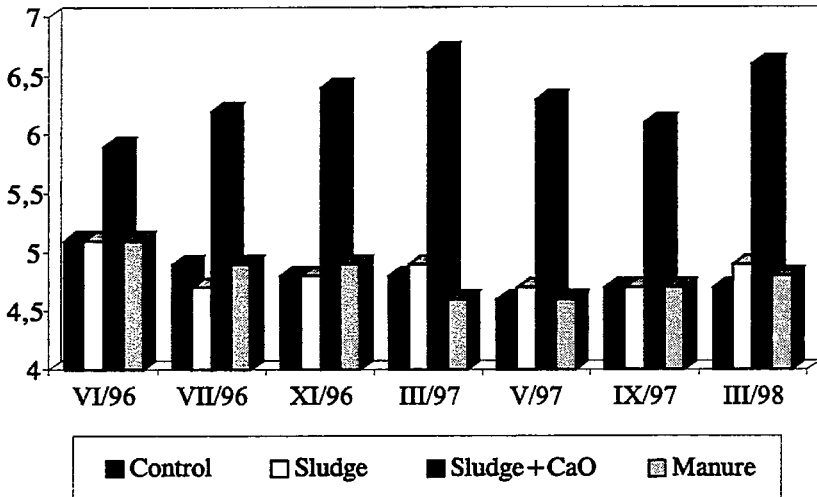

Figure 5  
Soil pH/KCl reaction after application of fertilizers.

mg N/kg/day

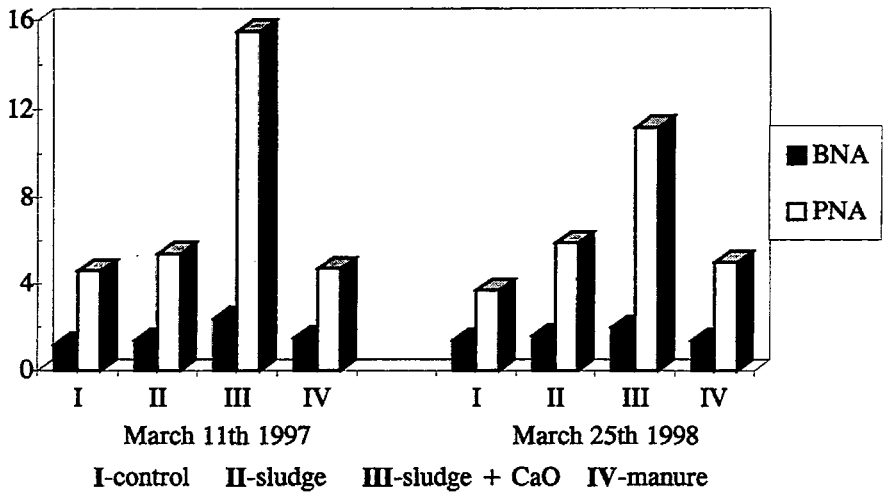
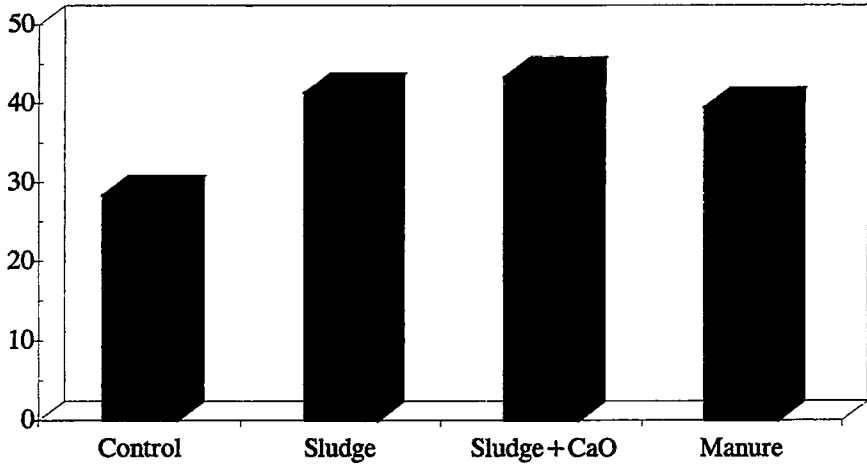

Figure 6  
Nitrification ability of soil.

yield (t per ha)



*Figure 7*  
*Yield of potato bulbs (1996).*

yield (t per ha)

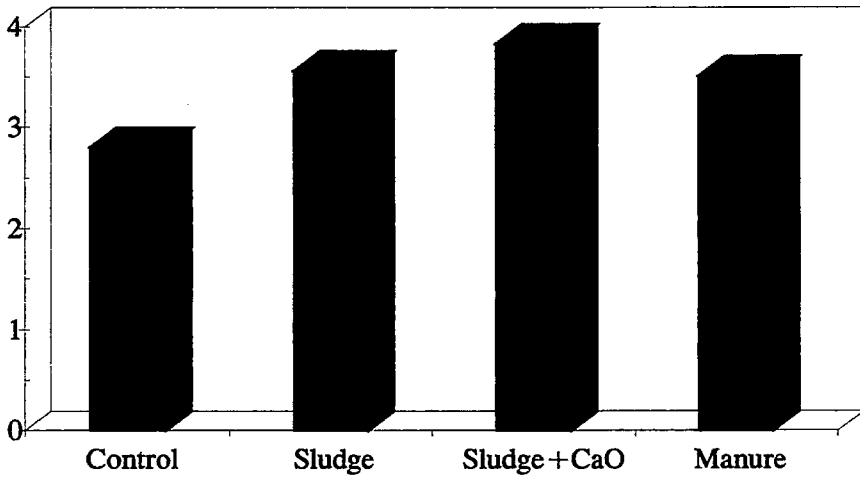

*Figure 8*  
*Yield of wheat corn (1997).*

## **4. Conclusions**

**4.1.** Direct agricultural application of sludges from sewage disposal plants introduce both hygienic and environmental risks. The accumulation of hazardous substances accumulation and the local infection sources can come due to heterogeneity of this material

**4.2.** Different methods of sludge treatment exist to hygienize ones. In the Czech Republic are convenient as follows: composting (at the temperature above 55°C for more than 21 days, with two overdigging), fermentation in the aerobic bioreactors (at the temperature above 65°C for more than 24 hours) or lime stabilization (minimal pH = 11.5 for 1 hour at least). Reaction conditions above named are in accordance with requirements for the regular fermentation processes course, i. e. the correct utilization of raw materials, carbon/nitrogen ratio, humidity, aeration etc.

**4.3.** The pathogenic micro-organisms in sludge are diminished by the lime biosolidization. Furthermore decreasing of heavy metals concentrations and their mobility carries out. The latter is caused by forming of slightly soluble hydroxides and carbonates. Hence the heavy metal transport in the food chain is restricted under correctly utilized dose and date of the lime stabilized sludge application.

**4.4.** Lime stabilized sludges must be application to soil 3 - 4 weeks before sowing or planting at least. The releasing of calcium as well as other nutrients take place more slowly from pelletized product than from lime stabilized sludge without a following treatment.

**4.5.** The highest yields of cultivated plants were found after the lime stabilized sludge application in comparison with differently treatment sludges, both in pot and field trials. Soil with this sludge had the higher mineralization and nitrification ability, nitrogen bonded in organic compounds, both in soil and sludge, was released more intensively. The consumption of nitrogen by plants was also higher in this variant.



## **Nitrogen regime of two bulgarian soils after 30 years of mineral and organic-mineral fertilisation ( $^{15}\text{N}$ study).**

*Statut azoté de deux sols bulgares après 30 ans de fertilisation minérale et organique (essais avec  $^{15}\text{N}$ ).*

**Vesselin Koutev and Erma Ikonomova**

N. Poushkarov Institute of Soil Science and Agroecology,

Agrochemistry Department,

7, Chaussee Bankya, 1080 Sofia, Bulgaria

E-mail : koutev@yahoo.com

### **Abstract**

The objective of this study is to determine some changes in the nitrogen regime of soils with long-term mineral and organic mineral fertilisation. The investigations have been carried out on two major Bulgarian soils : leached smolnitza (vertisol) and grey forest soil. Three treatments of long-term (30 years) mineral and organic-mineral fertilisation have been studied : 1. PK ; 2. NPK ; 3. NPK + farmyard manure (FYM - every other year). A modification of the method of Stanford-Smith for determination of soil nitrogen mineralisation potential based on the isotope dilution method has been worked out, taking into account the effect of applied mineral nitrogen fertilizers on the additional mineralisation of soil organic nitrogen. Microfield and pot experiments with maize and wheat have been carried out.

*Keywords : long-term fertilisation, nitrogen mineralisation potential, isotope dilution method.*

### **Résumé**

L'objectif de cette étude était de déterminer les changements dans le « statut azoté » de sols recevant des fertilisations minérales et organiques sur une longue période. Les essais ont été conduits sur deux sols typiques bulgares : un sol lessivé Smolnitza (vertisol) et un sol gris de forêt. Trois traitements de fertilisation longue durée (30 ans) minérale et organo-minérale ont été comparés : 1. PK ; 2. NPK ; 3. NPK + fumier. Une adaptation de la méthode de Stanford-Smith pour la détermination du potentiel de minéralisation de l'azote du sol a été proposée, basée sur la méthode de dilution isotopique. Des essais en microparcelles ainsi que des incubations en pots avec maïs et blé ont été poursuivis.

*Mots-clés : essais fertilisation longue durée, potentiel de minéralisation de l'azote, méthode de dilution isotopique.*

## 1. Introduction

Intensive arable farming faces several problems related to both soil fertility and environment (Broussaard et al. 1988). Among these urgent problems are the contamination of ground and surface water and the atmosphere, due to intensive use of fertilisers. One of the changes in farming practices proposed involves a partial replacement of mineral fertilisers by manure (Laanbroek H.J. and S. Gerards, 1991). Problems with organic fertilisers are possible too. Ammonium might be produced from manure at times when there is no need for mineral N by the plants. The following nitrification may lead to undesired effects on the environment, i.e., leaching of nitrate into ground water or the production of N-oxides by denitrifying bacteria.

Long-term applications of mineral and organic fertilisers open into significant changes in soil characteristics. The parameters of these characteristics vary considerably depending on the type of the soil-fertiliser-plant system.

The objective of this study is to determine some important for agriculture and environment changes in the nitrogen regime of soils with long-term mineral and organic mineral fertilisation.

## 2. Materials and methods

Soil Treatment	Leached smolnitza					Grey forest soil				
	Total N%	Organic C %	C:N	pH		Total N%	Organic C %	C:N	pH	
				H <sub>2</sub> O	KCl				H <sub>2</sub> O	KCl
*Soil - 1960	0.159	1.78	11.2	-	5.5	0.134	1.29	9.2	-	4.4
PK	0.142	1.79	11.9	6.1	5.0	0.128	1.12	8.8	5.9	4.9
NPK	0.160	1.89	12.7	5.6	4.7	0.138	1.23	8.9	5.8	4.9
NPK + FYM	0.212	2.44	11.5	6.1	5.3	0.171	1.62	9.5	5.4	4.4

\*Soil - 1960 - Data by Dinchev, 1983

*Table 1.*  
*Soil characteristics of long-term fertilised soil (30 years)*

Soils	Content of particles %	
	< 0,01 mm	< 0,001 mm
Leached smolnitza	71.4	53.9
Grey forest soil	50.4	28.5

*Table 2.*  
*Texture of studied soils*

The investigations have been carried out on two major Bulgarian soils: leached smolnitza (Pellic Vertisol, FAO) and grey forest soil (Orthic Luvisol, FAO). The texture of the leached smolnitza is clay and the texture of the grey forest soil is silty silt. Three treatments of long-term (30 years) mineral and organic-mineral fertilisation have been studied: 1. PK; 2. NPK; 3. NPK+ Farmacyard manure (FYM - every other year). Fertiliser's rates were 200 kg N.ha<sup>-1</sup>, 140 kg P<sub>2</sub>O<sub>5</sub>. ha<sup>-1</sup>, 120 kg K<sub>2</sub>O.ha<sup>-1</sup> and 40 tons farmyard manure per hectare. In experimental year farmyard manure have been applied on the grey forest soil before the maize.

### **Laboratory incubation experiment**

A modification of the method of Stanford-Smith for determination of soil nitrogen mineralisation potential based on the isotope dilution method (Fried and Dean, 1952) have been worked out, taking into account the effect of applied mineral nitrogen fertilisers on the additional mineralisation of soil organic nitrogen. The nitrogen mineralisation potential of the soils was determined by Stanford-Smith's method, 1972 and by our own modification of this method. The modification of method consists in the addition of  $^{15}\text{N}$  labelled nitrogen fertiliser (ammonium nitrate). No initial washing of the soil was done as to make possible soil incubation with ammonium nitrate. During the first two weeks soil moisture was 80% of field capacity. Throughout this period the fertiliser nitrogen have been incorporated into soil's cycle. Triplicate 15-g samples of soil and equal weights of quartz sand mixed thoroughly moistened for the PK treatment to 80% of FC and moistened and fertilised with 67 mg N.kg<sup>-1</sup> soil for the NPK and NPK+FYM treatments. The soil was retained in the 50-ml leaching tube by means of a glass wool pad. A thin glass wool pad was placed over the soil to avoid dispersing the soil when solution was poured into the tube. Present mineral N was removed by leaching with 100 ml of 0.01M CaCl<sub>2</sub>, followed by 25 ml of a nutrient solution devoid of nitrogen. Excess water was removed under vacuum. Tubes were incubated at 35°C for periods of 2, 4, 8, 12, 16, 22 and 30 weeks with intermittent leachings of mineral nitrogen.

### **Micro field experiments**

The micro field experiment was carried out on the leached smolnitza with wheat and on the grey forest soil with maize. Micro plots of 1 m<sup>2</sup> in the PK, NPK and NPK+FYM treatments have been used in the experiment. Same rate for fertilising have been used - 200 kg N.ha<sup>-1</sup> representing 20 g N per m<sup>2</sup>.

### **Pot experiments**

The pot experiment was carried out in 20 kg pots with maize and wheat as test crops on the two studied soils. The soils from the PK, NPK and NPK+FYM treatments have been used. The fertiliser rate evaluated for 1 kg soil - 67 mg N.kg<sup>-1</sup> soil has been applied.

The soil samples for pot and incubation experiments have been collected from the surface 30 cm depth of the three studied treatments of every soil. Labelled nitrogen have been applied as ammonium nitrate with %<sup>15</sup>N atom excess: 10% for the micro field experiment; 5 % for the pot experiment and 28% for the incubation experiment.

## **3. Results and discussion**

Changes in the soil pH were found between treatments in both soils. Acidification of soil has been observed in PK and NPK treatments of leached smolnitza and in NPK+FYM treatment of grey forest soil.

Long-term organic-mineral nitrogen fertilisation caused an increase in total nitrogen and organic carbon content (Table 1). The nitrogen mineral fertilisation had stopped the nitrogen fertility degradation. No changes have been observed in total nitrogen content in NPK treatment. Parallel application of mineral nitrogen and organic matter increased total nitrogen content as well as organic carbon content. Compared to the control (1960) total nitrogen decreased by 12% in PK treatment in leached smolnitza and by 5% for grey forest soil, not changed for NPK treatment and increased by 33% for NPK+FYM treatment in leached smolnitza and by 28% in grey forest soil. Compared to the control (1960) organic C increased by 6% for NPK treatment in leached smolnitza and by 10% in grey forest soil, organic C increase for NPK+FYM treatment was 36% for leached smolnitza and 45% for grey forest soil. Our results agree with related findings of other workers (Anderson and Peterson, 1973, Campbell 1978). The lower organic matter build up in leached smolnitza is mainly due to the relatively high level of organic matter already present in the soil. The C:N ratio increases on the leached smolnitza in mineral fertilising treatment and in organic - mineral fertilising treatment on grey forest soil.

Results have been obtained showing the available nitrogen and nitrogen mineralisation potential to increase under the influence of both the nitrogen fertilisers in the year of application and the long-term nitrogen fertilisation (Table 3). Values of the nitrogen mineralisation potential and the available nitrogen obtained by isotope dilution method were similar. The mineralisation potential, defined as amount of N susceptible to mineralisation in infinite time, ranged from 249 to 506 mg N.kg<sup>-1</sup> for the leached smolnitza and from 204 to 284 mg N.kg<sup>-1</sup> for the grey forest soil. The NPK+FYM treatments showed a stronger effect on the nitrogen mineralisation potential than NPK application, and this was related to the increasing organic carbon in soil. Campbell et al., 1986 also observed a sharp increase of potentially mineralisable nitrogen in fields where farmyard manure was applied regularly over a long period of time. The heaviest texture, favourable to organic matter stabilisation in soil, in the leached smolnitza had enabled higher nitrogen accumulation in readily decomposable N pool. According to Faurie (1980) large changes in the labile organic matter fraction are associated with high microbial biomass and nitrogen availability. The half part of the total nitrogen increase due to the farmyard manure application on leached smolnitza was found in nitrogen mineralisation potential pool, for the grey forest soil the increase of a nitrogen mineralisation potential represents a quarter part from total nitrogen increase. Therefore the plant accessible nitrogen pool increase in leached smolnitza significantly and nitrogen nutrition regime of soil became more favorable for plant development.

Treatment	* Soil N mg.kg <sup>-1</sup>	** Fertiliser N mg.kg <sup>-1</sup>	Available N mg.kg <sup>-1</sup>	N pot mg.kg <sup>-1</sup>
Leached smolnitza				
PK	174	-	-	249
NPK	306	54	380	367
NPK + FYM	395	52	509	506
Grey forest soil				
PK	164	-	-	204
NPK	192	62	257	232
NPK + FYM	232	58	299	284

\* Soil N - Soil nitrogen mineralised and leached for 30 weeks of incubation

\*\* Fertiliser N - Fertiliser nitrogen leached for 30 weeks of incubation

**Table 3**

*Changes in available nitrogen in soil after 30 years mineral and organic-mineral fertilising, determined by Stanford and Smith (1972) method (N pot. - nitrogen mineralisation potential) and isotope dilution method (Available N).*

The dry matter yield of wheat and maize and the nitrogen uptake with plants from pot and micro field experiments were higher in the organic-mineral fertilisation treatment. The better conditions for plant growing in the leached smolnitza reflected in about 50% increase in that treatment of dry matter yield and nitrogen uptake in the pot experiment with wheat (Table 4). The same treatment on grey forest soil increased the yield and nitrogen uptake 5-fold.

Treatments	Dry matter yield g per pot	Nitrogen uptake mg.kg <sup>-1</sup>			A value mg N.kg <sup>-1</sup>	FUE %	Ndff %
		N soil	N fertiliser	N sum.			
Leached smolnitza							
PK	127.6	65	-	65	-	-	-
NPK	164.5	74	41	115	119	61.1	35.6
NPK+FYM	177.7	94	43	137	145	64.2	31.4
Grey forest soil							
PK	32.3	15	-	15	-	-	-
NPK	146.3	41	40	81	69	59.7	49.4
NPK+FYM	152.1	47	40	87	79	59.7	46.0

**Table 4**

*Pot experiment with wheat*

Treatments	Dry matter yield g per pot	Nitrogen uptake mg.kg <sup>-1</sup>			A value mg N.kg <sup>-1</sup>	FUE %	Ndff %
		N soil	N fertiliser	N sum.			
Leached smolnitza							
PK	132.5	45	-	45	-	-	-
NPK	248.5	76	41	117	126	61.2	35.0
NPK+FYM	252.8	140	39	179	243	59.1	21.8
Grey forest soil							
PK	60.0	17	-	17	-	-	-
NPK	209.1	57	43	100	87	64.2	43.0
NPK+FYM	244.2	65	40	105	109	59.7	38.1

**Table 5**

*Pot experiment with maize*

Treatments	Leached smolnitza			Grey forest soil		
	N soil	N fertiliser	N sum.	N soil	N fertiliser	N sum.
PK	39	-	39	32	-	32
NPK	34	3	37	31	2	33
NPK+FYM	36	3	39	35	2	37

**Table 6**  
*Residual inorganic nitrogen after wheat in soil of pot experiment mg.N.kg<sup>-1</sup>*

Treatments	Leached smolnitza			Grey forest soil		
	N soil	N fertiliser	N sum.	N soil	N fertiliser	N sum.
PK	28	-	28	21	-	21
NPK	22	2	24	19	2	21
NPK+FYM	46	6	52	23	2	25

**Table 7.**  
*Residual inorganic nitrogen after maize in soil of pot experiment mg.N.kg<sup>-1</sup>*

Results for yield and nitrogen uptake are not in correlation with mineralisation potential. Coefficient of fertiliser use efficiency (FUE) was higher on the leached smolnitza. The half of the nitrogen uptake by plants on grey forest soil has been derived from fertiliser. In the conditions of leached smolnitza the nitrogen derived from fertiliser (Ndff) was about 30 - 35%.

The results obtained in the pot experiment with maize show that maize uses much better the soil nitrogen (Table 5). Yields in nitrogen fertilised treatments on leached smolnitza were nearly equal. On grey forest soil the organic - mineral nitrogen fertilising has been ensured yield of maize to increase to 244.2 g per pot. That yield is similar as on the leached smolnitza (252.8 g per pot). That's why it is possible to make a conclusion for the optimised status of the nitrogen regime in organic - mineral treatment on two studied soils. The coefficients of fertiliser use efficiency for maize were similar as for the wheat. The result for Ndff in the treatment NPK+FYM on leached smolnitza 21.8% show that in the soil has been accumulated amounts of a soil nitrogen sufficient for the plant's development. In support of that is the nitrogen mineralisation potential of this treatment - 506 mg N.kg<sup>-1</sup> and highest amounts of inorganic nitrogen in soil after the end of experiment (Tables. 3, 7 ).

The interest on determining relative N mineralisation capacities of soils is related with residual nitrogen in soil after harvesting, too. In humid-region agriculture residual nitrogen is a potential environmental hazard. In dryland cereal farming, on the other hand, the accumulation of mineral N is significant in supplying N to the succeeding crop. Limited volume of soil in pot experiments is the factor determining the similar amounts of residual nitrogen in soil, except the NPK+FYM treatment of maize on leached smolnitza (Tables 6, 7 ).

Treatments	Dry matter yield g. m <sup>-2</sup>	Nitrogen uptake mg.m <sup>-2</sup>			A value mg N.kg <sup>-1</sup>	FUE %	Ndff %
		N soil	N fertiliser	N sum.			
PK	905	9742	-	9742	-	-	-
NPK	1854	18114	9024	27138	57	45.1	33.3
NPK+FYM	1965	20253	9136	29389	63	45.7	31.1

*Table 8.*  
*Wheat micro field experiment on leached smolnitza*

Treatments	Dry matter yield g. m <sup>-2</sup>	Nitrogen uptake mg.m <sup>-2</sup>			A value mg N.kg <sup>-1</sup>	FUE %	Ndff %
		N soil	N fertiliser	N sum.			
PK	783	6141	-	6141	-	-	-
NPK	1662	17060	4040	21100	103	20.2	19.1
NPK+FYM	1970	18707	5796	24503	79	29.0	23.7

*Table 9*  
*Maize micro field experiment on grey forest soil*

The 30 years of organic-mineral fertilising ensure higher yields and nitrogen uptake in NPK+FYM treatment in micro field experiments with wheat and maize. In conditions of micro field experiments the coefficients of fertiliser use efficiency decreased with 25% for the wheat and 2 - 3 fold for maize compared to pot experiment conditions (Tables 8, 9).

Residual mineral nitrogen amounts are shown in Tables 10 and 11. Differences are due to soil type, crop properties and differences in water temperature regime of growing periods of wheat and maize.

The use of labelled nitrogen fertilisers allowed a comparison to be made of the results of soil nitrogen mineralisation potential determined by laboratory methods and the net nitrogen mineralisation in conditions of micro field and pot experiments with maize and wheat. The limited amounts of soil in the pot experiments make possibly the available nitrogen to be spent up more fully than in field conditions.

Treatments	Soil depth, cm	N soil	N fertiliser	N sum.
PK	0-30	17	-	17
	30-60	18	-	18
NPK	0-30	22	5	27
	30-60	22	2	24
NPK+FYM	0-30	24	3	27
	30-60	26	2	28

*Table 10.*  
*Residual inorganic nitrogen in leached smolnitza after wheat harvest mg.N.kg<sup>-1</sup>*

Treatments	Soil depth, cm	N soil	N fertiliser	N sum.
PK	0-30	18	-	18
	30-60	18	-	18
NPK	0-30	37	7	44
	30-60	22	2	24
NPK+FYM	0-30	37	4	41
	30-60	27	2	29

*Table 11.*  
*Residual inorganic nitrogen in grey forest soil after maize harvest mg.N.kg<sup>-1</sup>*

Introduction of the A-value (Fried and Dean, 1952) as an index of soil N availability has prompted considerable discussion regarding its merits and interpretations (Smith and Legg, 1971). The orthodox thesis that the A-value is a constant for a given soil did not be confirmed in our study. Irrespective of a great amount of soil used in the pot experiments (20 kg), the A-values differ substantially from those obtained in the field experiment. The A-values for wheat in pot experiments were similar as soil nitrogen uptake for maize (Tables 4, 5). It means than results for A-values in pot experiments with wheat as test crops were underestimated. The higher A-values obtained in the experiment with maize as a test crop, compared to those with wheat, enabled us to conclude that each obtained result is good for the soil-crop pair only.

#### **4. Conclusions**

The results of this study show significant change of soil pH, total N, organic C and C:N ratio depending of soil type and used fertilisers (mineral or organic - mineral). Available nitrogen and nitrogen mineralisation potential increased under the influence of both the nitrogen fertilisers in the year of application and the long-term nitrogen fertilisation. The heaviest texture, favourable to organic matter stabilisation in soil, in the leached smolnitza had enabled higher nitrogen accumulation in readily decomposable N pool. The dry matter yield of corn and maize and the nitrogen uptake with plants from pot and micro field experiments were highest in the organic-mineral fertilisation treatment. Coefficients for fertilizer use efficiency and nitrogen derived form fertiliser vary strongly in pot and field experiment. A-value determination of available soil nitrogen for a given soil is valid for studied soil-crop pair only. To maintain an optimal soil organic status and consequently optimal microbial activity for nutrient availability to plants, manures with the higher C content should be incorporated into soil.

#### **5. References**

1. **Anderson, F. N. and Peterson, G. A.** 1973. Effect of continuous corn (*Zea mays*), manuring and nitrogen fertilization on yield and protein content of the grain and on the soil nitrogen content. *Agric. J.* 65: 697 - 700
2. **Broussard L, van Veen J. A., Kooistra M.J., Lebbink G.** (1988) The Dutch programme on soil ecology of arable farming systems. *Ecol. Bull. (Stockholm).* 39: 35 - 40
3. **Campbell, C.A.** 1978. Soil organic carbon, nitrogen and fertility. Pages 173 - 265 in M. Schitzer and S.U. Khan, eds. *Soil organic matter. Developments in soil science.* Elsevier Scientific. Publ. Co., Amsterdam, The Netherlands. 319 pp.



4. **Campbell, C.A., Schitzer, M., Stewart, J.W.B., Biederbeck V.O. and Selles F.** 1986. Effect of manure and P fertilizer on properties of a Black Chernozem in Southern Saskatchewan. *Can. J. Soil Sci.* 66: 601 - 613
5. **Dinchev, D.** 1983. Nitrogen balances in the soils in Bulgaria. Zemizdat eds., Sofia, Bulgaria
6. **Faurie, G.** 1980. Devenir de l'ammonium en sol calcaire, nitrification et volatilisation de l' ammoniac. These de doctorat d'etat es sciences. Institut National de recherche, Paris, France
7. **Fried M., Dean L. A.** - 1952, A concept concerning the measurement of available soil nutrients. *Soil Science*, V.73, pp. 263-271
8. **Laanbroek, H.J. and S. Gerards.** 1991. Effect of organic manure on nitrification in arable soils. *Biol. Fertil. Soils.* 12: 147 - 153
9. **Smith, S.J. and Legg, J.O.,** 1971. Reflections on the A-value concept of soil nutrient availability. *Soil Science*, 96: 373 - 375
10. **Stanford G., Smith S. J.** - 1972, Nitrogen Mineralization Potentials of Soils, *Soil Science Society of America Proceeding.* v.36, pp 465 - 472



## Predicting the fertilizer nitrogen value of farm manure applications to agricultural land.

*Prévision de la valeur « azotée » de déjections animales épandues en agriculture.*

**F. A. Nicholson, B. J. Chambers**  
ADAS Gleadthorpe Research Centre,  
Meden Vale, Mansfield,  
Notts NG20 9PF, UK  
E-mail : Fiona\_Nicholson@adas.co.uk

**E. I. Lord, K. A. Smith**  
ADAS Wolverhampton, Woodthorne,  
Wergs Road, Wolverhampton,  
WV6 8TQ, UK

### Abstract

*A computer based decision support system to predict the fate of N following organic manure applications to land was developed, drawing together the latest research information on factors affecting manure N availability. The MANure Nitrogen Evaluation Routine (MANNER) accounts for manure N analysis, ammonia volatilisation, incorporation timing, nitrate leaching and mineralisation of manure organic N. Predictions from MANNER have been evaluated by comparison with independently collected experimental data. Good agreement was found between predicted and actual fertiliser N values for poultry manure, pig slurry and cattle slurry ( $p < 0.001$ ), confirming that MANNER provides a simple, quick and accurate estimate of the fertiliser N value of different farm manures spread under a range of circumstances.*

*Keywords : organic manures, nitrogen, modelling, land application*

### Résumé

Un système informatique d'aide à la décision destiné à prédire le devenir de l'azote consécutivement à l'épandage de déjections animales a été développé sur les bases des dernières connaissances disponibles.

Le système désigné par MANNER (MANure Nitrogen Evaluation Routine) prend en compte l'analyse de l'azote des déjections, la volatilisation de l'ammoniac, les conditions d'épandage (incorporation), la lixiviation des nitrates et la minéralisation de l'azote organique des déjections.

Les prévisions issues du système MANNER ont été comparées avec des données expérimentales indépendantes. Une bonne concordance a été établie entre les valeurs prédites et les valeurs fertilisantes obtenues pour du fumier de volailles, lisier de porc et lisier bovin ( $p < 0.001$ ), confirmant l'intérêt du système qui permet une estimation simple, rapide et fiable de la valeur azotée des déjections animales.

Mots-clés : déjections animales, azote, modélisation, épandage.

# 1. Introduction

Land application represents the most cost effective outlet for organic manures and allows their nutrient and organic matter content to be utilised to supply crop nutrient demands and maintain soil fertility. However, it is clear from annual statistics on fertiliser use in the UK (Burnhill *et al*, 1994) that farmers make little or no allowance for the contribution of manures to crop fertiliser requirements, even where applied regularly and to a large proportion of the crop area. Whilst a number of factors contribute to the poor on-farm utilisation of manures, lack of confidence in accurately predicting the fertiliser N value of a manure dressing is an important issue (Smith and Chambers, 1995).

Recent UK research has contributed significantly to an improved understanding of the nitrogen supply characteristics of organic manures and this is now reflected in current advice (MAFF, 1994). However, a straightforward message is required for effective advice with simple decision support systems playing an increasingly important role in the practical application of research information.

## 2. Theoretical background

Nitrogen (N) transformations and losses following the land application of organic manures are many and complex. Comprehensive models which predict the fate of manure N should take account of each pathway in order to arrive at a robust estimate of the amount of crop available N. In addition, such models should be verifiable against independent experimental data and, if they are intended to have a practical application, should be easy to use and only require readily obtainable input data.

### 2.1 Rationale behind the current model

The ADAS 'MANNER' model (MANure Nitrogen Evaluation Routine) is a simple PC-based decision support system which has drawn together the latest information on factors affecting organic manure N availability and losses following land application. "MANNER" is designed to provide a quick estimate of the fate of manure N following land applications, for a range of agricultural situations. Currently not all N loss pathways and transformations are covered by the model. Although it is recognised that these may be of significance, on the basis of current UK knowledge, it has not been possible to include factors describing N immobilisation or denitrification.

In its present form, the model has 3 screens for data input : i) manure type/analysis, ii) incorporation and iii) leaching (eg. Figure 1). Comprehensive help screens and a User Guide are provided to assist the farmer/consultant with entering the information. A single screen, output (which can be saved to disk or printed) is

produced which summarises both the data inputs and the fate of manure N, in terms of ammonia volatilised, nitrate leached, plant available N for current crop and organic N mineralised for next crop.

The calculations required to produce the model outputs are performed in the sequence as described below.

The screenshot shows a software window titled "Manure Details". It features three tabs: "Type/Analysis", "Incorporation", and "Leaching". The "Type/Analysis" tab is active. The form contains the following fields and values:

- Site Identification: Top Field
- Manure Type: Layer Manure
- Units: Metric
- Rate: 10 t/ha
- Analysis (fresh weight):
  - Dry Matter: 30.0 %
  - Total N: 15.0 kg/t
  - Ammonium plus Uric acid N: 7.50 kg/t

On the right side of the window, there are four buttons: Report, Clear, Help, and Exit.

Figure 1  
Example of a MANNER data input screen

## 2.2 Manure application rate and analysis.

The manure type and rate of application are required model inputs. A total of 17 organic manure types, including sewage sludges, can be selected from a drop-down menu (Figure 1). Information is required on the manure total N, ammonium N, uric acid N (poultry manures only) and dry matter (DM) content. Default values based on typical analyses are provided. However, as manure total N content and the relative proportions of the different N forms will vary according to animal diet, conditions of manure handling and storage, etc, it is important that actual analysis data, relating to the manure applied, are input where possible.

### 2.3 Ammonia volatilisation.

Ammonia volatilisation is generally the first major loss pathway for manure ammonium N following land application. Typically, 65% of the ammonium-N content of FYM and 35% of the ammonium+uric acid -N content of poultry manure can be lost through ammonia volatilisation (Chambers *et al.*, 1997).

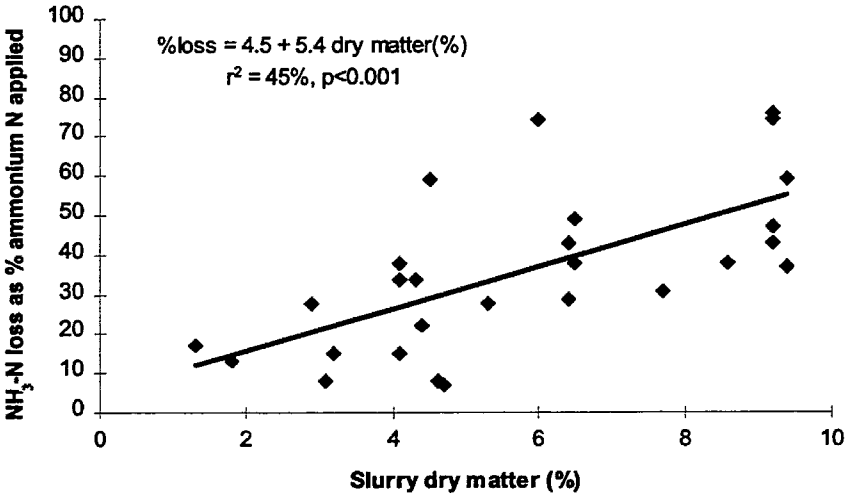

Figure 2  
Relationship between slurry dry matter content and ammonia loss

Where slurries are surface applied, DM content has a large influence on ammonia loss (Sommer and Olesen, 1991). UK research measurements (Smith and Chambers, 1995) have shown an increase in ammonia-N loss of 5-6% of the ammonium-N applied per 1% increase in slurry DM, within a range of 1-9% DM (Figure 2). The speed of incorporation is also important - soil incorporation can be very effective in reducing losses, the more rapid the incorporation (particularly for slurries), the greater the impact in reducing losses. In recent field experiments, ammonia losses were measured following the surface application of cattle and pig slurries and a range of solid manures (broiler and turkey litter; layer manure; pig and cattle FYM). The ammonia loss curves were fitted with Michaelis-Menton type equations which have been successfully used by other researchers to describe ammonia emissions following land spreading (Sommer and Ersboll, 1994). MANNER estimates potential ammonia volatilisation from slurry depending on the dry matter content, before calculating actual ammonia loss in relation to soil incorporation practices using Michealis-Menton equations. Ammonia losses from surface spread separated slurries and liquid sewage sludges are calculated in the same way.

## 2.4 Crop uptake.

No allowance is made in the model for crop uptake of N overwinter or in early spring, because this is usually fully supported by background soil mineral N supplies, the manure N, at these early stages, being largely 'surplus to requirements'.

## 2.5 Nitrate leaching.

The total water content in the soil profile at field capacity to 1m depth (volumetric moisture content -  $V_m$ ) is defined by the soil texture and determines the soil's susceptibility to leaching. In the model, 15 different topsoil/subsoil textures are recognised. A simple piston flow model is used to describe water movement through the soil profile. This assumes that the volume of rainwater entering the soil displaces an equal volume of water through drainage, once the soil has reached field capacity.

However, not all of the rain which falls will drain into the soil as some will be lost through evapotranspiration. The 'effective' rainfall (ER) is thus the difference between actual rainfall (AR) and the amount lost through evapotranspiration. Data on evapotranspiration losses from fields with different crop cover types are available in the UK, however, it is unlikely that the farmer will have ready access to these. The model therefore uses a simple algorithm to calculate ER from AR. If no rainfall data is input, the model uses a typical value (if appropriate) for the period between manure application and the end of drainage.

The amount of N lost through leaching is then calculated based on the amount of readily 'available' N (ammonium+uric acid-N for poultry manures and ammonium-N for other manures) remaining after ammonia volatilisation, using the following relationship :

$$AN_l = AN_v (ER/V_m - 0.5) \quad (1)$$

where  $AN_l$  is the amount of readily 'available' N remaining after leaching,  $AN_v$  is the amount of available N remaining after ammonia volatilisation and the value of  $(ER/V_m - 0.5)$  is constrained to lie between 0 and 1.

If the manure was ploughed down within 1 month of application, it is assumed to have 'by-passed' the topsoil (average incorporation depth is ca. 25 cm), with the  $V_m$  therefore accounting only for capacity of the subsoil, before being used in Equation 1.

## 2.6 Mineralisation.

Mineralisation of manure organic N additions will result in some N becoming available for crop uptake, even if all the readily 'available' N has been lost earlier through ammonia volatilisation or nitrate leaching. For MANNER, data from field experiments conducted in the UK using manures applied at normal agronomic rates (Smith *et al*, 1994; Chambers *et al.*, 1996) were used to derive the following mineralisation equations:

$$N_m = N_o \times 0.1 \text{ (for FYM, slurry and spring applied poultry manure)} \quad (2)$$

$$N_m = N_o \times 0.2 \text{ (for autumn applied poultry manure)} \quad (3)$$

where  $N_o$  is the amount of organic N in the manure and  $N_m$  is the amount of mineralised organic N that will be utilised by the growing crop.

## 3. Model validation

One of the most important aspects of model development is testing the output against data collected independently from that use to assemble the actual model components. Comparisons of MANNER generated predictions of manure fertiliser N values for solid manures and slurries, with experimental data, are shown in Figures 2 and 3.

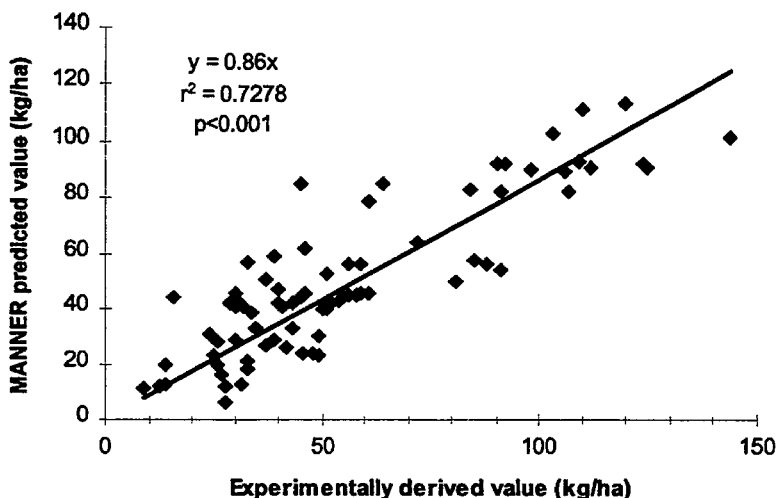

*Figure 2.*  
*Comparison of MANNER predicted and experimentally derived fertiliser N values for solid manures applied to cereals*



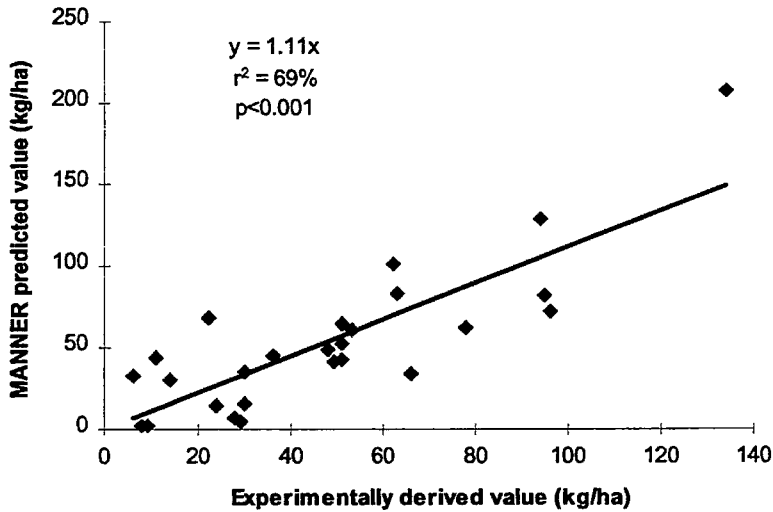

**Figure 3**  
*Comparison of MANNER predicted and experimentally derived  
 fertiliser N values for slurries applied to cereals*

Good agreements ( $r^2$  ca. 70%;  $P < 0.001$ ) between the model predictions and experimentally derived data, confirm that MANNER can provide a simple, and accurate estimate of the fertiliser N value of different farm manures spread under a range of circumstances.

#### 4. Acknowledgements

Funding for this work from the UK Ministry of Agriculture, Fisheries and Food (MAFF) is gratefully acknowledged.

#### 5. References

Anon, (1991). Council Directive Concerning the protection of water against pollution caused by nitrates from agricultural sources. Official Journal of the European Communities (91/676/EEC) 8572/91.

Burnhill, P., Chalmers, A. G. and Fairgreave, J. (1994) *Fertiliser Use on Farm Crops 1993*. British Survey of Fertiliser Practice 1994. Fertiliser Manufacturers Association, Ministry of Agriculture, Fisheries and Food. The Scottish Office Agriculture and Fisheries Department, HMSO Scotland.

**Chambers, B. J., Williams, J. and Smith, K. A. (1996).** Residual effects of poultry manures. In *Progress in Nitrogen Cycling* (eds. O. van Klempt *et al*). pp. 183-190

**Chambers, B. J., Smith, K. A. and van der Weerden, T. J. (1997).** Ammonia emissions following the land spreading of solid manures. In *Nitrogen Emissions from Grasslands*. Eds. S. C. Jarvis and B. F. Pain. CAB International, pp 275-280.

**Ministry of Agriculture Fisheries and Food, (1994).** *Fertiliser Recommendations for Agricultural and Horticultural Crops*. Reference Book 209 (6th ed.), HMSO, London.

**Smith, K. A. and Chambers B. J. (1995)** Muck: from waste to resource. Utilisation: the impacts and implications. *Agricultural Engineer* Vol 50 autumn, 1995, pp 33-38.

**Sommer, S. G. and Olesen, J. E. (1991).** Effects of dry matter content and temperature on ammonia loss from surface applied cattle slurry. *Journal of Environmental Quality*, 20, pp 679-683.

**Sommer, S. G. and Ersb II, A. K. (1994).** Soil tillage effects on ammonia volatilization from surface-applied or injected animal slurry. *Journal of Environmental Quality*, 23, pp 493-498.

# **Bacteriological and chemical (nitrogen, phosphorus) characterization of liquid wastes discharged by four dairy farms (Vendée, France).**

*Caractérisation bactériologique et chimique (azote, phosphore) des effluents émis par quatre élevages laitiers (Vendée, France).*

**S. Reyné, J. Marrec**

SCE Environmental Consultants,  
Atlantpole, BP 10 703 -  
F 44 307 Nantes cedex 3, France  
Tel : 33 (0)2- 40- 68-79 00 (51-12)  
fax : 33 (0)2- 40- 68-79 43  
e-mail : eau@sce.fr

**S. Reyné, C. Cheverry**

ENSA-INRA Laboratoire de Recherche  
de Science du Sol,  
65, rue de Saint-Brieuc,  
F 35 042 Rennes cedex, France  
Tel : 33 (0)2- 99-28-50-00  
fax : 33 (0)2- 99-28-54-30

## **Abstract**

*Experimental device were set up on four dairy farms of a 23 km<sup>2</sup> watershed. Three farmsteads, including livestock buildings and characterized by different cattle numbers and levels of equipment, were hydrologically isolated to concentrate all liquide wastes flowing out to surface water at one single outlet. Grab and average effluent samples were collected through two winters (1995 and 1997). Fecal coliforms (FC) concentrations were close to 105-106 FC/100 ml. Those concentrations are similar from one farm to other, and do not depend on cattle numbers. Nitrogen losses (50% ammonia) reached 10 kg N/Livestock Unit (L.U.) between november and apris of the most rainy winter. Total phosphorus losses reached 4 kg P/L.U. (60% phosphates).*

Keywords : livestock housing, cattle effluents, fecal coliforms, phosphorus.

## **Résumé**

Des dispositifs de mesure expérimentaux ont été mis en place sur quatre élevages laitiers d'un bassin versant de 23 km<sup>2</sup>. Trois exploitations, regroupant l'ensemble des bâtiments et différentes par leur cheptel et leur niveau d'équipement, ont été isolées hydrologiquement de façon à collecter l'ensemble des effluents émis dans le milieu en un seul exutoire. Des échantillons fractionnés et moyens ont été prélevés au cours de deux campagnes hivernales, en 1995 et 1997. Les concentrations en coliformes fécaux (CF) sont proches de 105-106 CF/100 ml. Elles sont comparables d'une exploitation à l'autre, et ne dépendent pas de la taille du cheptel. Les pertes en azote, pour moitié sous forme ammoniacale, ont atteint 10 kg N/UGB entre novembre et avril de l'hiver le plus pluvieux. Les flux de phosphore ont atteint 4 kg P/UGB, dont 60% sous forme de phosphates.

Mots-clés : bâtiments d'élevage, effluents bovins, coliformes fécaux, phosphore.

## **1. Introduction**

Agricultural delivery of nitrogen and phosphorus to surface water is usually considered as coming from non-point sources. As a matter of fact, research focuses on diffuse pollution caused by fertilizers at different study scales, from experimental plots to watersheds (Heathwaite *et al.*, 1996). Concerning bacteriological contamination, different experimental studies and models are developed to quantify run-off contamination after unsafe slurry applications (Bouedo *et al.*, 1991 ; Moore, 1989).

On the other hand, little work has been done on agricultural point sources pollution due to livestock (Parráková and Fratic, 1980, Anonymous, 1992a -b, 1995). Two main sources are however responsible for surface water bacteriological contamination by livestock. First, animal manure is a source of pathogens and nutrients as animals water straight in rivers and ponds (Hunter and Mc Donald, 1990). Solutions exist, such as fencing livestock from streams and providing off-stream watering areas (Godwin and Miner, 1996). Second, stock farms impacts can be quite important as livestock housing do not conform to a few basic advocations, such as having sufficient storage facilities. A highly concentrated effluent can flow out of the farmstead within the winter stalling period (four to six months). A recent investigation hold in France shows that this situation is not uncommon at all. Freysse and Michaud (1997) pointed out that liquid manure and wastewaters are not stored for 50% per cent of the cattle. Moreover, 19% cattle buildings set up at less than 35 meters from a waterway. At least, livestock operations seem to be responsible for different diseases outbreaks, which is quite worrying for both human and animal health (Pell, 1997).

In order to study the real impact of animal houses on water quality and to compare it with non point sources pollution, an experimental study was carried out on a Vendée small watershed (France). This paper deals with the main results collected straight downstream of four dairy farms.

## 2. Study area

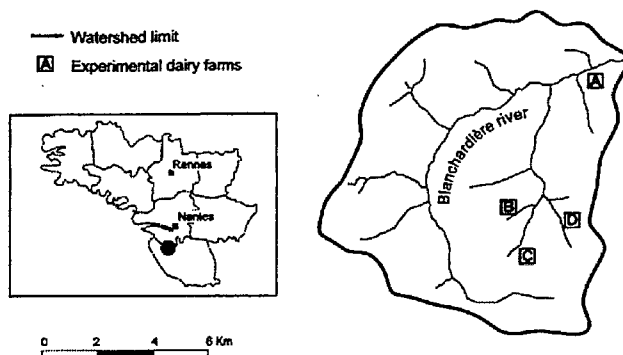

Figure 1.

*Location of the Blanchardière catchment area in relation to Western France ;*

Figure 1 shows location of the Blanchardière watershed (23km<sup>2</sup>) in relation to Western France. Most of the 18 cattle farms of the area are mixed crop-livestock farms, rearing dairy cows and bull calves. A specific inquiry in 1994 pointed out an average lack of liquid manure storage tank of 620 m<sup>3</sup> per cattle farm. However, few cattle breeders whose livestock exceeded the limit of 70 Livestock Units (L.U.) have to comply with the Programme of Control of Pollution from Agricultural Origin (PCPAO). As part of this programme, they have to improve their livestock housing and manure storage facilities to put an end to wastewater discharges.

Table 1 compares the 4 experimental farms main breeding characteristics, considered as representative of all the farms of the area. The four dairy farms (A, B, C, D) are set up within the 200 meters area lining the nearest waterway. A, B and C show important storage capacity shortage, whereas dairy farm D carried out important improvements as part of the PCPAO.

	Experimental dairy farms			
	A	B	C	D
<b>FARM LIVESTOCK</b>				
Cattle number (L.U.)	63	112	109	120
Dairy cows number	38	50	50	57
<b>STOCK RAISING PRACTICES</b>				
Animal buildings	free-stall housing			
Dairy cows exercise area roofing	no roof		roofed	
Stalling period	half-november to half april (4 to 6 months)			
Loose straw on bedding area (kg.straw.week <sup>-1</sup> .L.U. <sup>-1</sup> )	15	20	30	18.5
Liquid manure storage lack (m <sup>3</sup> )	1.373	425	634	0
Solid manure storage lack (m <sup>2</sup> )	0	242	45	0

Table 1

*Characteristics of the four experimental livestock farms (A, B, C, D)*

### 3. Methods

#### 3.1. Measuring equipment

The four farmsteads were fenced by a ditch collecting the whole effluent flowing out. One single outlet gathered the main effluents in a two meters long concrete channel :

- liquid manure streaming from animal houses and manure storage facilities whose walls and bottom were not tight,
- milking parlour wastewater,
- storm water trickling over dirty concrete areas and bunker silos.

Figure 2 represents farm buildings and storage facilities of dairy farm B as an example of an experimental site.

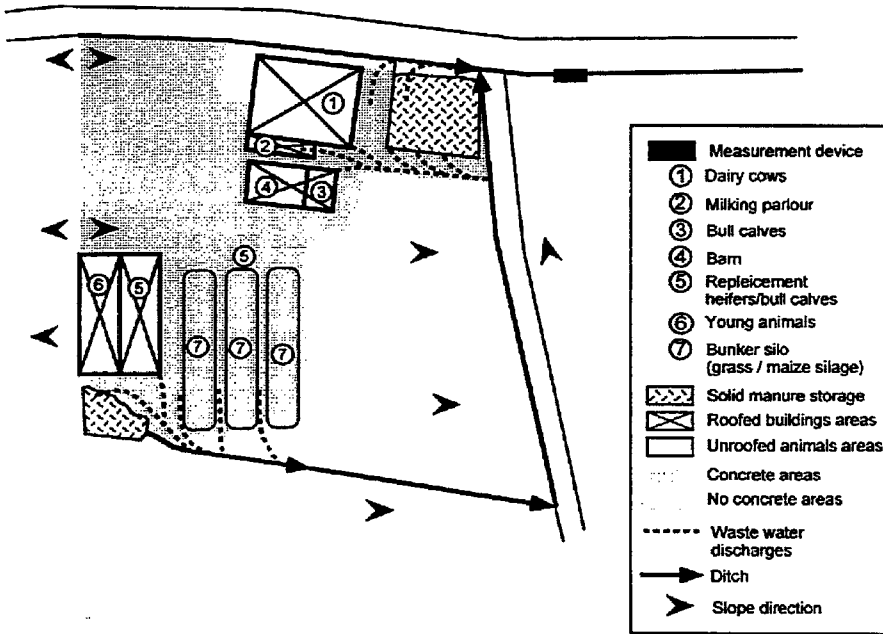

Figure 2.  
Location drawing of dairy farm B.

A measuring and collecting equipment was installed straight downstream the artificial outlet. Data loggers SAB600 HDL recorded wastewater level in the channel every 6 minutes. Automatic samplers ISCO 3700 connected to data loggers collected samples in the concrete channel. A rain gauge connected to the data logger measured rainfall every 6 minutes. As data loggers were equipped with modem, samplers were easily remote activated according to rains.

### 3.2. Sampling programme

The sampling programme combined two series of average samples.

- a series of average samples was planned during storm events, to evaluate flood concentrations. Hydrograph events were studied through flow-slaved samples, so that sample collection frequency increased in proportion to waterflow.
- a series of time-slaved samples described wastewater average baseflow concentrations continuously produced by the dairy farms.

### 3.3. Analytical methods

Effluent samples were kept cold (4°C) and dark to the Veterinary Analysis Laboratory of Vendée. They were analyzed for orthophosphates (P-PO<sub>4</sub>), total phosphorus (TP), ammonium (NH<sub>4</sub>) and total Kjeldahl nitrogen (N-TKN).

Orthophosphates are coupled with ammonia molybdate and reduced by ascorbic acid to form a coloured compound measured at 800 nm. Total phosphorus is measured at the same wavelength after mineralization with sulfuric acid. (Rodier, 1996, AFNOR NF T 90-023). Ammonium (NH<sub>4</sub>) was measured colorimetrically at 630 nm (Rodier, 1996, AFNOR NF T 90-015). Organic nitrogen was converted to ammonium by sulfuric acid mineralization and next determined by subtracting ammonium from total Kjeldahl nitrogen (Rodier, 1996, AFNOR NF T 90-110).

Bacteriological samples were collected in sterilized 250 ml polyethylen stoppered flasks and put to culture within 8 hours after collecting. Fecal coliforms (FC) were selected as fecal indicators, and a Membrane Filtration technique used for coliforms enumerations. Membranes are first incubated 24 hours at 44°C on Triphenyltetrazolium and Tergitol media, fecal coliforms are next confirmed at the same temperature on a Lactose medium (Rodier, 1996, AFNOR NF T 90-414).

## 4. Results and discussion

### 4.1. Dairy farms A, B, C within november 1994 to april 1995.

Table 3 shows main results concerning baseflow and flood chemical elements concentrations.

Baseflow concentrations were very high and varied over a wide range of values. N-TKN and N-NH<sub>4</sub> concentrations were particularly high for all samples (263.3-798 mg N.l<sup>-1</sup> for N-TKN, 224-612.7 mg NH<sub>4</sub>.l<sup>-1</sup>), followed by orthophosphates and total phosphorus. Farm C samples were at least twice more concentrated than farms A and B samples. On these latter whose animals exercise areas had no roof, effluents were slightly more dilute by urine and wastewater between two rainfalls.

Flood concentrations varied over a narrow range of values (11.9-25.4 mg P. l<sup>-1</sup>, 45.1-110.7 mg N. l<sup>-1</sup>). The higher concentrations were observed on farm A, and no longer on farm C. Dairy farm C was particularly poorly equipped with liquid manure storage facilities within the study period. Rainfall played here an essential role by massively displacing liquid manure badly stored in a no-tight storage tank. The amount of ammonia in total Kjeldahl nitrogen was almost constant from one farm to another, and close to 53.6% ( $\pm$  9.4). The amount of orthophosphates in total phosphorus was close to 61.2% ( $\pm$  5.7) in all samples.

For all samples, outflows between two storm events were highly more concentrated than samples collected during a significant storm event (rainfall > 5mm). The baseflow / flood concentrations ratio varied from 2.1 to 3.7 for the different phosphorus forms on A and B, to 8.6 and 8.8 for dairy farm C.

The nitrogen baseflow / flood ratios varied as phosphorus but were twice higher for TKN and N-NH<sub>4</sub> (from 4.4 to 9.2 on farms A and B, and 11.6 and 16.3 on farm C), which could suggest that nitrogenous compounds were leached more easily than phosphorus compounds, specially during baseflow periods.

		dairy farms		
		A	B	C
baseflow mean concentrations	TP (mg P/l)	53.0	44.9	107.2
	P-PO <sub>4</sub> (mg PO <sub>4</sub> /l)	112.5	79.2	209.6
	N-TKN (mg N/l)	490.0	263.3	798.0
	N-NH <sub>4</sub> (mg NH <sub>4</sub> /l)	387.0	224.0	612.7
flood mean concentrations	TP (mg P/l)	25.4	11.9	12.5
	P-PO <sub>4</sub> (mg PO <sub>4</sub> /l)	43.1	23.1	23.8
	N-TKN (mg N/l)	110.7	45.1	68.4
	N-NH <sub>4</sub> (mg NH <sub>4</sub> /l)	73.5	24.2	37.5

Table 3.

*Total phosphorus (TP), orthophosphates (P-PO<sub>4</sub>), total Kjeldahl nitrogen (N-TKN), ammonium (N-NH<sub>4</sub>) mean concentrations of baseflow samples (n=5) and flood samples (n=10) collected on farms A, B, C, within november 1994 to april 1995*

Continuous flow recorded permitted to estimate both baseflow and flood volumes, and by the way, to estimate nitrogen and phosphorus losses (Table 4). Within a 181 days study period characterized by a 520 mm cumulated rainfall, the most important losses were observed on the smallest farm (63 L.U.) where they reached 208.7 g N. L.U.<sup>-1</sup> day<sup>-1</sup>. Baseflow losses represented about a third of the 3 farms total export.

The comparison of the 3 farms pointed out main explanatory factors such as insufficient liquid manure storage capacity, or husbandry practices. Insufficient quantity of straw on bedding area and insufficient cleaning of the exercise and alimentation areas generated a semi-liquid manure, which was more easily



removed from the solid manure storage facility. Farm C which had a bigger liquid storage shortage than farm B, showed smaller losses thanks to roofed animals areas and to the greater amount of straw used by the breeder to get a high dry matter farmyard manure.

	dairy farms		
	A	B	C
TP (g P.L.U. <sup>-1</sup> . day <sup>-1</sup> )	77.2	34.4	22.5
TKN (g N. L.U. <sup>-1</sup> . day <sup>-1</sup> )	208.7	72.1	91.7

*Table 4.*  
*Total phosphorus (TP) and total Kjeldahl nitrogen (TKN) losses within 181 days (november 1994 to april 1995)*

Concerning fecal coliforms, table 5 presents steady geometric means from one farm to another. Minima and maxima confirmed that the concentrations varied over a narrow range of values, (4.3-6.4 log<sub>10</sub> fecal coliforms per 100 ml). No significative difference was found between the 3 farms, neither on baseflow concentrations, nor on flood conditions.

		dairy farms		
		A	B	C
baseflow concentrations (log <sub>10</sub> fecal coliforms / 100ml)	mean	5.50	5.53	5.49
	minimum	5.18	5.09	5.04
	maximum	5.96	5.89	5.98
flood concentrations (log <sub>10</sub> fecal coliforms / 100ml)	mean	5.88	5.32	5.39
	minimum	5.46	5.03	4.30
	maximum	6.40	5.78	5.90

*Table 5.*  
*Fecal coliforms bacteria concentrations of background samples (n=5) and flood samples (n=10) collected on farms A, B, C, within november 1994 to april 1995*

#### **4.2. Comparison of farm B with a well equipped dairy farm within november 1996 to april 1997**

As part of the PCPOA, dairy farm D carried out important improvements during summer 1996. Animals areas were roofed, solide manure storage facilities were made waterproof and all wastewater collected to a new 1,000 m<sup>3</sup> drained tank. Dairy farm D was compared with dairy farm B which was the most similar farm of the area considering livestock and animal housing (table 1). Means concentrations are presented in table 6.

Concentrations measured on dairy farm B within november 1996 to april 1997 were comparable with concentrations obtained within november 1994 to april 1995 (table 3).

As soon as improvements were achieved on dairy farm D, baseflow concentrations did not exceed 14.9 mg N.l<sup>-1</sup> and 3.48 mg P. l<sup>-1</sup>. These mean concentrations were twenty times as concentrated as B for total phosphorus, and sixty times as concentrated for total Kjeldahl nitrogen.

Dairy farm D flood mean concentrations appeared to be twice smaller than baseflow concentrations for main parameters, but no significant difference was found. Dairy farm B flood mean concentrations reached 50.4 mg N.l<sup>-1</sup> and 14.4 mg P. l<sup>-1</sup>. Even with rain dilution, these concentrations remained ten times as high as dairy farm D.

		B (non improved)	D (improved)
baseflow mean concentrations	TP (mg P/l)	43,2	1,8
	P-PO <sub>4</sub> (mg PO <sub>4</sub> /l)	88,3	2,0
	N-TKN (mg N/l)	348,5	9,1
	N-NH <sub>4</sub> (mg NH <sub>4</sub> /l)	304,6	5,0
flood mean concentrations	TP (mg P/l)	14,4	1,1
	P-PO <sub>4</sub> (mg PO <sub>4</sub> /l)	29,6	1,2
	N-TKN (mg N/l)	50,4	4,4
	N-NH <sub>4</sub> (mg NH <sub>4</sub> /l)	30,7	2,7

Table 6.

*Total phosphorus (TP), orthophosphates (P-PO<sub>4</sub>), total Kjeldahl nitrogen (N-TKN), ammonium (N-NH<sub>4</sub>) mean concentrations of baseflow samples (n=12) and flood samples (n=7) collected on farms B et D within november 1996 to april 1997*

Fecal coliforms enumerations on dairy farm B in 1996-97 confirmed both baseflow and flood concentrations in 1994-95, with a baseflow mean concentration of 5.78 log<sub>10</sub> fecal coliforms / 100ml (4.96-6.79 log<sub>10</sub> fecal coliforms / 100ml) and a flood mean concentration of 5.29 log<sub>10</sub> fecal coliforms / 100ml (4.78-5.9 log<sub>10</sub> fecal coliforms / 100ml).

Fecal coliforms enumerations at dairy farm D outlet showed wide variations. At the beginning of the study period, all facilities improvements were not achieved. Peaks occurred on former samples, as wastewater was not collected and channeled to the tank (5.99 log<sub>10</sub> fecal coliforms / 100ml). Once improvements were achieved, the enumerations revealed less than 30 FC / 100 ml, except for one sample (4.32 log<sub>10</sub> fecal coliforms / 100ml ) collected as the breeder was cleaning a spreader and sent wastewater to the ditch and not to the tank.

## 5. Acknowledgments

The authors gratefully acknowledge the Bay of Bourgneuf Watershed Development Association and the main contributors to NORSPA european programme (LIFE-29/FR/001)

## 6. References

**Anonyme (1992a)** Expérimentation sur les effluents d'élevages bovins. Etude Conseil Général des Côtes d'Armor, SDAE 22, 92 p.

**Anonyme (1992b)** Bâtiments d'élevage et environnement : les rejets d'un élevage laitier. Etude Direction Départementale des Affaires Sanitaires et Sociales et Chambre d'Agriculture de la Sarthe (E.D.E.), 29p.

**Anonyme (1995)** Traitement expérimental des effluents d'élevage par lagunage naturel : une année de suivi dans deux exploitations agricoles. Etude Conseil Général de Loire-Atlantique, 18p.

**Frayse J.-L. et Michaud D (1997)** Bâtiments d'élevage bovin et environnement : beaucoup de progrès à faire. Agreste, Les Cahiers, mars 1997, 13 : 3-11.

**Godwin D.C. and Miner J.R. (1996)** The potential of off-stream livestock watering to reduce water quality impacts. Bioresource Technology, 58 : 285-290.

**Bouedo A., Bertru M., Guiziou F. et Bertrand M. (1991)** Etude du risque de contamination fécale des eaux après épandage de lisier. Informations Techniques du CEMAGREF, décembre 1991, n°84, note 1, 8p.

**Heathwaite A.L., Johnes P.J. and Peters N.E (1996)** Trends in nutrients. Hydrological Processes, 10 : 263-293.

**Hunter C. and Mc Donald A. (1990)** Seasonal changes in the sanitary bacterial quality of water draining a small upland catchment in the Yorkshire Dales. Water Resources Research, 25(4) : 447-453.

**Moore J.A., (1989)** Predicting the fate and movement of bacteria in agricultural runoff. Land and Water Use, Dodd & Grace (eds), Balkema, Rotterdam, 311-317.

**Parrakova E. and Fratic I. (1980)** Soil contamination in the environment of intensive farming units. Agricultural Wastes, 2 : 161-170.

**Pell A.N (1997)** Manure and microbes : public and animal health problem ? Journal of Dairy Science, 80(10) : 2673-2681.

**Rodier J. (1996)** L'analyse de l'eau, eaux naturelles, eaux résiduaires, eau de mer. Editions Dunod, Paris, 8ème édition, 1383p.



## **Long term effects of excessive organic waste application.**

*Effets à long terme d'épandages excessifs de déchets organiques.*

**A. Siegenthaler, H. Häni and W. Stauffer.**

Swiss Federal Research Station for Agroecology and Agriculture  
Institute of Environmental Protection and Agriculture, Liebefeld, CH-3003 Bern  
E-mail : Albrecht.Siegenthaler@IUL.admin.ch

### **Abstract**

*The change of soil properties, crop yields and crop contents from the last seven years of a field experiment, started in 1976, with high amounts of sewage sludge and pig slurry application (2 and 5 tons of organic matter per hectare and year) are discussed. Levels of zinc and cadmium reached or even exceeded actual limits of Swiss legislation. We observed that the essential elements (copper and zinc) are mainly concentrated in the generative parts (grain), whereas cadmium is mainly found in the vegetative parts (straw, leaves) of the plant. A lowering of the soil pH-value by a few tenths increased the solubility of the heavy metals in the soil.*

Keywords : sewage sludge, pig slurry, long term field experiment, plant nutrition, heavy metals

### **Résumé**

Les modifications des propriétés du sol, des rendements des cultures et de leur teneur au cours des sept dernières années d'un essai au champ débuté en 1976, avec apports excessifs de boues et de lisier de porc (2 à 5 tonnes de M.O. par ha et par an) sont discutés. Les niveaux de zinc et cadmium atteignent, voire dépassent, les valeurs seuils établies par la législation suisse. Les éléments essentiels (cuivre et zinc) sont principalement concentrés dans les grains alors que le cadmium s'accumule dans les parties végétatives (paille, feuille) des plantes. Une diminution du pH s'accompagne de l'augmentation de la solubilité des métaux traces dans le sol.

Mots-clés : boues, lisier porc, essais au champ longue durée, nutrition, cultures, métaux lourds.

## 1. Introduction

Sewage sludge and pig slurry of good quality are very valuable organic fertilizers. Because both contain a high amount of nitrogen and organic matter, they are potentially dangerous for water resources. Less is known about adverse long-term effects of metals in the soil on crop yield and metal uptake after excessive organic waste application.

The following paper shows the results obtained between 1991 and 1997 in a field trial with very high amounts of sewage sludge and pig slurry. The trial was installed in 1976 and is aimed at contributing towards a solution of the problems associated with the use of sludge and pig slurry.

## 2. Experimental design

### 2.1. Aims of the trial

The trial aims at clarifying the middle and long term effects of the application of large amounts of treated sewage sludge (SS) and pig slurry (PS) on

- the soil: physical, chemical and biological parameters;
- the plants in a crop rotation: yield, contents of nutrients and heavy metals

### 2.2. Methods of fertilizer application, crop rotation and soil cultivation

Two different quantities of sewage sludge and pig slurry were used, resulting in the following six different treatments :

- 0 = no fertilizer
- min = mineral standard fertilizing (N,P,K,Mg)
- SS2 = sewage sludge 2 t organic matter per hectare and year
- SS5 = sewage sludge 5 t organic matter per hectare and year
- PS2 = pig slurry 2 tons organic matter per hectare and year
- PS5 = pig slurry 5 tons organic matter per hectare and year

The amount of organic matter (OM), plant nutrients and heavy metals applied annually are shown in Table 1. The values represent the average amount over the 21 years of fertilizer application. The allowed zinc and copper contents of pig-feed as well as the mean contents of sewage sludges were lowered several times since 1976. Unwin (1996) suggested to estimate metal loadings to the soil from calculations based on the metal content of feedingstuffs or on analyses of slurry and manures.

Between 1976 and 1984 wheat, grass-clover and silage maize were cultivated in a simple 3-year rotation. In 1985, after 9 years, the trial was modified. Cabbage, celery and spinach were grown. Between 1988 and 1990 a silage maize period of

three years followed. In 1991 the trial was started again with a prolonged crop rotation (Table 2).

Treatments	OM	N	P	K	Ca	Mg	Cu	Zn	Cd	
1	0	0	0	0	0	0	-	-	-	
2	min	0	140	45	220	69	**	**	**	
3	SS2	2000*	200	130	250	365	81	1.7	6.9	0.014
4	SS5	5000*	400	350	250	980	98	4.4	18.6	0.039
5	PS2	2000*	320	95	240	160	52	0.6	2.7	0.002
6	PS5	5000*	800	260	430	450	83	1.8	7.9	0.006

\* rounded values. \*\* not determined ; 0 = without fertilizing since 1976, min = mineral standard fertilization, SS = sewage sludge, PS = pig slurry.

**Table 1**  
*Amounts of organic matter (OM), plant nutrients and heavy metals of each fertilizing treatment (kg/ha, per annum).*

Year	Culture
1991	sugar beet « KAWETINA »
1992	winter wheat « RAMOSA » / catch crop fodder
1993	potatoes « DESIREE »
1994	spring barley « MICHKA » / grass-clover mixture
1995	grass-clover mixture « STM 200 MEDIA »
1996	silage maize « LG 11 » / winter triticale
1997	winter triticale « MERIDAL » / oats-vetch mixture

**Table 2**  
*Crop-rotation*

Soil cultivation aimed at effective mechanical weeding for a clean seed bed, essential for the growing of a good crop. This was mainly achieved with a plough. In some instances, the plough was replaced by a rotary harrow. Great care was taken in the cultivation of the soil in order to avoid damages.

### 2.3. Trial plan

The trial was 12m wide and 104m long and divided into 6 parts (4m x 13m) for the six different treatments. Each treatment was repeated four times and chosen at random.

### 2.4. Soil properties

At the beginning of the trial, the soil was thoroughly analysed and classified with soil profiles. The following gives a short description of the trial field:

- location : Liebefeld, 3km south-west of Berne, on moraine deposits (alluvial plain), 564m above sea level;
- soil texture : sandy clay soil (medium heavy), slightly stony;
- soil type : poorly developed para-brown earth, pH-value approximately 6, humus content 3.5%

## 2.5. Climate

During the last seven years, the average temperature was 9.1°C with a mean maximum of 31.9°C and a mean minimum of -12.2°C. The annual average rainfall was 1036 mm and the annual average sunshine duration 1627 hours.

## 3. Results and discussion

### 3.1. Development of soil characteristics

Table 3 shows different soil characteristics for 1986 and 1994. At the beginning of the trial in 1976 the **pH-values** in the top soil were between 6.0 and 6.4. Not surprisingly, the soil pH-value changed considerably during the trial. The pH-value on the plots with no fertilizer application decreased by 0.7 units from 6.0 to 5.3. With mineral standard fertilizing the pH-value decreased only slightly. On the other hand, the sewage sludge application clearly increased the pH-value by 0.1 to 0.8 units. However, pig slurry application significantly lowered the pH-value compared to the original situation in 1976.

An increase in the **organic carbon content** of the soil was observed in the treatment with 5t organic matter of sewage sludge (SS5). As shown by Mediavilla et al., 1995 this also had a positive effect on the porosity and bulk density of the soil.

A significant increase in the **phosphate** content was measured in the treatments with large amounts of pig slurry and sewage sludge. Apparently, the plants could not utilise all the supplied phosphate. Where large amounts of pig slurry were applied, the P-test value increased from 5-10 up to levels of 90 (standard range 8-16). Ecologically and from an agricultural point of view, such levels are undesirable. There is always a danger of phosphate losses when such high concentrations occur. The level of phosphate also increased slightly up to 20 in the mineral standard fertilizer treatment. The last revision of the Swiss fertilizing recommendations (Walther et al., 1994) took these results into consideration and suggested a reduction of recommended phosphate doses.

The **total copper** contents of soil at the beginning of the trial was between 10 to 30 ppm. During the trial period, these levels increased to 30 and 54 ppm at high application levels of pig slurry and sewage sludge respectively. The increase in the soil copper content was less significant with pig slurry than with sewage sludge application. The new Swiss guidelines prescribe an upper limit of 40 ppm (Swiss Federal Council (1998, in preparation): Ordinance Relating to Soil Impairments ).

Concerning **total zinc** contents in the soil similar observations could be made. The initial amount detected was 40 to 60 ppm. High amounts of pig slurry increased the zinc contents only slightly. High sewage sludge applications, however, increased



the levels to 150 ppm and more. The new allowed guideline level (150 ppm) is exceeded.

Average values for each treatment (0-20cm), <u>underlined</u> values exceed the guide values										
	pH (H <sub>2</sub> O)	C org %	P-Test <sup>1)</sup>	K-Test <sup>2)</sup>	Cu		Zn		Cd	
					ppm total <sup>3)</sup>	ppb soluble <sup>4)</sup>	ppm total <sup>3)</sup>	ppb soluble <sup>4)</sup>	ppm total <sup>3)</sup>	ppb soluble <sup>4)</sup>
<b>1986</b>										
0	5.2	1.44	6.9	1.15	18.2	n.a.	47.7	n.a.	<0.250	n.a.
min	5.7	1.60	23.5	5.00	18.5	n.a.	48.4	n.a.	<0.250	n.a.
SS2	6.2	1.73	16.4	5.25	26.7	n.a.	94.4	n.a.	0.308	n.a.
SS5	6.4	2.01	20.7	4.10	36.9	n.a.	<u>150.8</u>	n.a.	0.698	n.a.
PS2	5.3	1.65	38.4	4.33	21.8	n.a.	57.8	n.a.	<0.250	n.a.
PS5	5.2	1.82	93.8	2.85	24.5	n.a.	68.3	n.a.	<0.250	n.a.
<b>1994</b>										
0	5.3	1.31	6.2	0.7	24.2	76	51.0	<u>928</u>	0.258	11.6
min	5.6	1.43	19.9	3.7	23.5	85	53.0	<u>505</u>	0.220	5.3
SS2	6.1	1.71	11.7	5.2	35.1	100	91.9	200	0.476	<2.6
SS5	6.8	2.10	12.8	2.7	<u>54.1</u>	109	<u>152.4</u>	88	<u>0.841</u>	<2.6
PS2	5.1	1.48	30.7	2.8	27.0	121	57.0	<u>1715</u>	0.234	10.6
PS5	4.9	1.56	64.4	3.5	30.4	181	66.8	<u>2268</u>	0.216	9.2

Guide values Swiss federal ordinance	Cu		Zn		Cd	
	ppm total <sup>3)</sup>	ppb soluble <sup>4)</sup>	ppm total <sup>3)</sup>	ppb soluble <sup>4)</sup>	ppm total <sup>3)</sup>	ppb soluble <sup>4)</sup>
Ordinance Relating to Pollutants in Soil 1986.	50	700	200	500	0.8	30
Ordinance Relating to Soil Impairments 1998, (proposed)	40	700	150	500	0.8	20

<sup>1)</sup>P-Test value (Method: CO<sub>2</sub>-saturated water, 1: 2.5): 8 - 16 sufficient, 16.1 - 32 reserve, >32 enriched

<sup>2)</sup>K-Test value (Method: CO<sub>2</sub>-saturated water, 1: 2.5): 2 - 4 sufficient, 4.1-8 reserve, >8 enriched

<sup>3)</sup>Total content: Extracted by nitric acid (2 M HNO<sub>3</sub>), 1: 10

<sup>4)</sup>Soluble content: Extracted by sodium nitrate (0.1 M NaNO<sub>3</sub>), 1: 2.5

0 = without fertilizing since 1976; min = mineral standard fertilization, SS = sewage sludge; PS = pig slurry; n.a. = not analysed.

*Table 3*

*Soil characteristics measured in 1986, 1990 and 1994 as well as Swiss guide values for heavy metals in soil.*

The initial amounts of **total cadmium** found in the soil were 0.2 to 0.25 ppm. The level increased to 0.4 and 0.84 ppm in the sewage sludge treatments. Present and new guidelines allow a maximum cadmium level of 0.8 ppm. Pig slurry application did not increase the values.

In 1994 the **soluble heavy metal contents** in the soil were measured. In no treatment the copper content was higher than the allowed guideline level. For soluble zinc the guideline values were slightly exceeded in the mineral fertilizing treatment and clearly exceeded in the no fertilizing and pig slurry treatments. The amounts of soluble zinc and cadmium in the soil are strongly related to the soil pH-

value. Therefore, the highest soluble contents of zinc and cadmium were found at low pH-values even if the total contents were low.

McGrath et al. (1995) from Rothamsted Experimental Station (UK) report that  $N_2$ -fixation by free living heterotrophic bacteria was inhibited at soil metal concentrations of (ppm): 127 Zn, 37 Cu and 3.4 Cd. It is concluded that prevention of adverse effects on soil microbial processes and ultimately soil fertility, should be a factor which influences soil protection legislation.

### **3.2. Crop yields**

The yields of the unfertilised treatment (0) was lower than all the other treatments by a factor of two or more for all cultures except grass-clover mixture. Compared to the standard mineral fertilizing treatment sugar beet, winter wheat and potatoes reacted with statistically significant lower yields in some cases of high sewage sludge or pig slurry application. Probably these crops do not tolerate such high amounts of nitrogen. In contrast, high sewage sludge and pig slurry applications showed higher or equal yields for spring barley, grass-clover mixture, silage maize, triticale and oats vetch mixture. The high application of nitrogen and other nutrients was best tolerated by silage maize and grass-clover mixture. The adverse effect of high amounts of nitrogen in case of pig slurry application increased with the duration of the experiment.

### **3.3. Heavy metal contents of crops**

The copper, zinc and cadmium contents of the harvested crops are shown in table 5. Compared to mineral standard fertilizing some of the crops grown on the treatments with sewage sludge or pig slurry showed statistically significant higher contents of **copper**.

Due to the relatively high amount of **zinc** found in sewage sludge and pig slurry (see table 1) the zinc content of the crops was significantly higher in comparison to the mineral fertilizer treatment. The highest zinc contents for most of the crops were found on the pig slurry treated plots. The significant decrease of soil pH-values in unfertilized and pig slurry treated plots obviously increased the solubility of zinc in the soil which was the reason for increased plant uptake.

High applications of organic fertilizer moderately influenced the **cadmium** content of crops. Often the highest cadmium contents were found in unfertilized plots. This is probably due to the combined effects of low pH, low organic matter content of the soil and reduced plant growth.

In agreement with Stadelmann and Frossard (1992) we found that in most cases the essential elements (copper and zinc) were concentrated in the generative parts of the plant (grain). On the other hand, cadmium was mainly found in the vegetative

parts of the plant (straw of wheat and barley). When applied in excess, both organic fertilizers induce high heavy metal contents in the plants.

Cu (mg/kg dry matter)	sugar beet 1991		winter wheat 1992		potatoes 1993 tuber	spring barley 1994		grass-clover mixture 1995
	root	leaves	grain	straw		grain	straw	
0	5.18	10.8	4.75	2.23	6.59	9.20**	5.50	9.04*
min	5.06	8.7	4.50	2.03	6.76	6.67	4.30	7.99
SS2	5.66**	10.6	5.50*	1.90	5.48	7.35*	4.37	11.24**
SS5	6.25**	11.0	5.50*	1.93	6.55	7.62**	3.41	11.29**
PS2	4.90	9.6	5.50*	2.65	8.48**	7.09	4.09	8.15
PS5	4.87	9.3	7.25**	3.85*	10.15**	8.71**	5.09	10.69**
ssd5	0.43	2.5	0.98	1.37	0.61	0.61	1.40	0.94
ssd1	0.60	3.5	1.35	1.89	0.84	0.84	1.92	1.30

Zn (mg/kg dry matter)	sugar beet 1991		winter wheat 1992		potatoes 1993 tuber	spring barley 1994		grass-clover mixture 1995
	root	leaves	grain	straw		grain	straw	
0	42.8**	195**	47.5	18.6	19.6	49.5**	29.2**	50.0*
min	31.8	100	42.5	12.5	18.4	38.3	15.8	43.8
SS2	49.1**	233**	53.8**	26.3**	17.1	47.5**	23.2*	58.0**
SS5	35.9	156*	50.3*	13.7	15.7	46.3*	18.4	52.9**
PS2	53.3**	185**	64.5**	35.9**	22.7**	55.3**	29.7**	57.5**
PS5	65.8**	220**	73.0**	67.5**	33.5**	76.7**	50.1**	65.6**
ssd5	7.5	55.1	6.0	9.8	2.7	6.3	6.4	5.8
ssd1	10.3	75.7	8.3	13.5	3.7	8.7	8.8	8.0

Cd (mg/t dry matter)	sugar beet 1991		winter wheat 1992		potatoes 1993 tuber	spring barley 1994		grass-clover mixture 1995
	root	leaves	grain	straw		grain	straw	
0	315**	1097**	74.9**	143	190.3**	53.1	138.3**	109.2**
min	228	535	51.6	117	94.9	46.8	73.4	86.3
SS2	190	539	67.0*	142	70.8	41.4	52.1	86.1
SS5	161	423	84.6**	120	51.2	46.7	49.2	76.2
PS2	263	643	70.7*	204**	60.1	49.5	83.6	84.6
PS5	243	560	72.7**	234**	59.5	58.2**	92.2	62.9
ssd5	41.1	132	14.1	28.5	32.5	7.9	19.0	11.7
ssd1	66.5	182	19.3	39.1	44.7	10.9	26.2	16.1

(0 = no fertilizer, min = mineral standard fertilizing, SS2 / 5 = sewage sludge 2 / 5 t organic matter per hectare and year, PS2 / 5 = pig slurry 2 / 5 tons organic matter per hectare and year)

**Table 5**  
*Contents of copper, zinc and cadmium detected of crops*

Note: \*ssd5 = smallest significant difference, means followed by one star (\*) are significantly different from mineral standard fertilizing treatment at P = 0.05; \*\* ssd1 = smallest significant difference at P = 0.01; n = 4.

## **4. Conclusion**

The main conclusions are the following :

**4.1.** No fertilizing and application of high amounts of pig slurry decreased the pH-values of the soil. The nutrient contents in the soil, especially phosphate, increased considerably through the application of high amounts of organic fertilizers.

**4.2.** Large amounts of organic fertilizers, mainly pig slurry, significantly decreased the yield of several crops probably due to nitrogen surplus.

**4.3.** Crops grown on unfertilized and pig slurry treated acid soils are mostly enriched with heavy metals. Compared to mineral standard fertilization crops grown on sewage sludge treated soils often show significantly increased heavy metal contents, especially zinc. A well-balanced fertilization adjusted to the plant nutrient uptake is the best guarantee for an harmonised crop content.

**4.4.** For a sustainable plant production, livestock density (pigs included) should be strictly adapted to the surface of agricultural land. A limit of three livestock units per hectare seems to be too high from an ecological and an agricultural point of view (increased soluble zinc content in the soil, partly increased contents of copper, zinc and cadmium in crops in treatment PS2).

**4.5.** To keep soils clean for future generations it is absolutely necessary to lower heavy metal limits in soils, sewage sludges and animal feedingstuffs. A first step in this direction was taken in Switzerland by the revision of the guide values for soils in 1998.

## **5. Acknowledgements**

The authors wish to thank Oskar Fankhauser and Johann Aeberhard for the field work and sample collection, Mrs. Charlotte Dähler, Mrs. Brigitte Schüpbach, Dr. Hans-Jörg Bachmann and Karol Krocka for analysing the samples. Many thanks to Dr. Peter Lischer and Mrs. Beatrix Stauffer for statistical support and Mrs. Maria Atkinson-Bernhard for improving the English.

## **6. References**

**McGrath SP, Chaudri AM and Giller KE (1995):** Long-term effects of metal in sewage sludge on soils, microorganisms and plants, *J Ind Microbiol*, 14 (2), 94-104.

**Mediavilla V., Stauffer W. und Siegenthaler A. (1995):** Schweinegülle und Klärschlamm: Einfluss auf N-Gehalt im Boden, AGRARFORSCHUNG, 2(7), 265-268.

**Siegenthaler A., Stauffer B. and Häni H. (1996):** Heavy metal contents of soil and plants due to very high amounts of pig slurry and sewage sludge, In: Hall J E (ed), European Research Network on Animal Waste Management Proceedings of a Workshop held on, 9-11 October 1996 in Gödöllő, Hungary.

**Stadelmann F.X. and Frossard R.(1992):** Schwermetalle in den Kulturpflanzen; Bedeutung und Einträge aus der Luft, SIL Zollikofen, Separatdruck, 40pp.

**Swiss Federal Council (1986):** Ordinance Relating to Pollutants in Soil.

**Swiss Federal Council (1992):** Ordinance Relating to Substances, Appendix 4.5.

**Swiss Federal Council (1998):** Ordinance Relating to Soil Impairments (in preparation).

**Swiss Federal Law of Water Protection (1991),** art. 14.

**Unwin RJ (1996):** Heavy metal content of animal manures - problems of assessment and control, In: Hall J E (Ed), European Research Network on Animal Waste Management Proceedings of a Workshop held on, 9-11 October 1996 in Gödöllő, Hungary.

**Walther U., Menzi H., Ryser J.P., Flisch R., Jeangros B., Kessler W., Maillard A., Siegenthaler A.F., Vuilloud P.A. (1994):** Grundlagen für die Düngung im Acker- und Futterbau, AGRARFORSCHUNG, 1, 7, 3-40.



## **Chairman's summary of part 2 bis Agronomic value of organic wastes Maria-Pilar BERNAL**

The organic wastes can be a source of nutrients for plant nutrition.

The papers presented focused on:

- characterisation of the wastes to be recycled.
- estimation of the proper application rate and method to be used in agriculture.
- evaluation of waste treatments which may improve their fertilising value.

A wide range of wastes have been studied, ranging from very well known to less known wastes: sewage sludges, animal manures, city refuse, pig slurry, human wastes, cattle house effluents, etc. Crop production (yields) and quality have been evaluated in pot and field experiments as the main indication of the waste fertiliser value as well as the changes in soil characteristics by short-term and long-term field experiments. Especial attention has been paid to nitrogen, supporting the N uptake evaluation with mineralisation studies. The agronomic value of the wastes also depends on their treatment. The treatments of wastes have been focused to improve the fertiliser value of the wastes comparing to mineral fertiliser. Treatments studied include : composting, anaerobic treatment, centrifugation and separation of solid and liquid phases of slurries, pelletisation and additives such as CaO.

The main conclusion achieved can be summarised in the following points:

- **sewage sludge:** the addition of this waste to soil showed a rapid N mineralisation rate, while the N mineralisation of composted sewage sludge was taken place later, making this material more suitable for background application. Composting of dewatered sludge led to a organic fertiliser, which supplied mainly K and P. The agronomic efficiency of differently treated sewage sludges revealed the convenience of using palletised sludge with lime, as the amended soil had higher mineralisation and nitrification capacities. High application rates of sewage sludge and also pig slurry, have been showed to be tolerated by silage maize but not by sugar beet and clover in long-term experiments, leading to a high P-accumulation in the soil and high concentrations of Zn and Cu.
- **Pig slurry:** microbiological studies showed the survival of faecal bacterial in soil treated with pig slurry, enterococci survived better than E. Coli which was very sensitive to increase temperature. A balance between high crop production and low water pollution can be achieved with repeated and exclusive fertilisation with pig slurry and its application can be done in spring or mid-autumn but a denitrification inhibitor should be added to the latter.
- **Animal manures:** the yield effect of nitrogen form cattle manure, composted and stacked manure, can be improved by combining both the organic treatment with the mineral N fertilisation. In long-term experiments, the yield and N uptake of crops was also improved when farmyard manure was combined with the

mineral fertiliser, leading this treatment to a higher nitrogen mineralisation potential of the soil in comparison with only inorganic fertilisers. The fertiliser nitrogen value of animal manure to soil can be predicted by a recently developed decision support system (MANNER), which only requires a few simple inputs provided by the farmers.

- **Other wastes:** the nitrogen content in human urine is high and most of it is in available forms to plants. However, the application of human urine to soil decreased the yield of crops with respect to a mineral fertiliser and the risk of nitrate leaching was similar to other organic or mineral fertilisers. Cattle housing effluents can be an important source for disseminating pathogens, but also high amounts of N and P nutrients can be lost in this wastes, leading to surface water pollution.



**Part 3 bis**

**Measurement, modelling and control  
of gaseous emissions.**

**Chairman : G. STEFFENS (Germany)**



# Emissions of NH<sub>3</sub>, N<sub>2</sub>O and CH<sub>4</sub> from composted and anaerobically stored farmyard manure

*Emissions de NH<sub>3</sub>, N<sub>2</sub>O et CH<sub>4</sub> lors du stockage de fumier composté ou stocké en anaérobie.*

**Amon B., Amon Th., Boxberger J.**  
Institut für Land-, Umwelt- und Energietechnik, Universität für Bodenkultur, A-1190 Wien (ILUET)  
E-mail : kiesslin@edv2.boku.ac.at

**Pöllinger A.**  
Bundesanstalt für alpenländische Landwirtschaft, A-8952 Irdning (BAL).

## Abstract

*A large open-dynamic-chamber has been developed and is now used to assess the emissions from all sectors of animal husbandry. It covers an area of 27 m<sup>2</sup> and can be built up over different emitting surfaces or manure heaps. It enables emission measurements of up to 8 t of manure under practical conditions. The compost emitted more NH<sub>3</sub> (823 g/t) than the anaerobically stored solid manure (287 g/t). The NH<sub>3</sub> emission from the compost amounted to about 10% of the total nitrogen content of the fresh manure. Half of the total emissions of the anaerobically stored solid manure was emitted after spreading. The compost did not emit any NH<sub>3</sub> after spreading. The results show the importance of measuring emissions during storage as well as during and after spreading, if emissions of different treatments are to be evaluated. Anaerobically stored solid manure emitted much more greenhouse gases (N<sub>2</sub>O : 74.7 g/t and CH<sub>4</sub> : 1493.8 g/t) than the compost (N<sub>2</sub>O : 49.8 g/t and CH<sub>4</sub> : 151.1 g/t). If environmentally friendly manure management systems are to be found, it is not sufficient to measure only one gas. The emissions of NH<sub>3</sub>, CH<sub>4</sub> and N<sub>2</sub>O have to be considered and reduced.*

**Keywords :** emission measurement, solid manure, ammonia, methane, N<sub>2</sub>O.

## Résumé

Les émissions gazeuses sont mesurées à l'Institut d'Ingénierie pour l'Agriculture et l'Environnement (ILUET) à l'aide d'une chambre ouverte dynamique qui couvre une surface de 27 m<sup>2</sup>. Cette chambre permet de mesurer les émissions issues de tas de plus de 8 t. de produit. Le fumier composté émet davantage d'NH<sub>3</sub> (823 g/t) que celui géré de façon anaérobie (287 g/t). Le fumier géré en conditions anaérobies émet davantage de gaz à effet de serre : N<sub>2</sub>O : 74.7 g/t et CH<sub>4</sub> : 1493.8 g/t que celui composté : N<sub>2</sub>O : 49.8 g/t et CH<sub>4</sub> : 151.1 g/t.

**Mots-clés :** mesure émissions, déjections solides, ammoniac, méthane, protoxyde d'azote.

## 1. Introduction

Farmyard manure can either be anaerobically stored or aerobically composted. Most of the investigations that have been carried out so far concentrated on ammonia emissions from composted FYM (DEWES 1996, RÖMER ET AL. 1994). Recently also N<sub>2</sub>O and CH<sub>4</sub> emissions have been included in the measurements on the laboratory scale (e.g. HÜTHER ET AL. 1997, OSADA ET AL. 1997). Emission measurements should be carried out under field conditions and should include all ecologically harmful gases. As the way of storing farmyard manure influences the change of manure composition (esp. NH<sub>4</sub> content) and as the composition of the farmyard manure influences the amount of ammonia emissions after spreading (MENZI ET AL. 1997), the emissions during storage and after spreading of the manure should be included in the investigations.

## 2. Experimental

If the emission rate is to be determined, gas concentration and air flow have to be known. Concentrations of NH<sub>3</sub>, N<sub>2</sub>O and CH<sub>4</sub> are analysed by a high resolution FTIR spectroscope. For the determination of the air flow over manure storages and during and after spreading of manure the ILUET has developed a large open-dynamic-chamber (AMON ET AL. 1997). It is described in "Emissions of NH<sub>3</sub>, N<sub>2</sub>O and CH<sub>4</sub> from a tying stall for milking cows, during storage of solid manure and after spreading" in these proceedings.

The ILUET compared emissions from anaerobically stored and aerobically composted FYM from a tying stall for milking cows under summer and under winter conditions. The summer period lasted from June to September 1996, the winter period from March to June 1997. Two heaps of farmyard manure were stored on concrete slabs with a drainage system. Seepage water emissions during storage were collected and analysed for their N content. The temperature in the two heaps was measured continuously at six places in each heap. Table 1 shows the composition of the composted and the anaerobically stored FYM and the mean temperature inside the manure heaps. The large open-dynamic-chamber was moved from one heap to the other three times a week to measure the emissions. In the summer trial each manure heap consisted of 3.5 t of farmyard manure. In the winter trial about 7t of farmyard manure were investigated.

	DM [%]	Nt [kg/t]	NH <sub>4</sub> -N [kg/t]	C/N	pH	temp. [°C]
<i>summer</i>						
composted FYM (su)	28.3	6.60	1.10	14	7.55	45.0
anaerobically stored FYM (su)	20.4	6.39	1.17	14	7.43	35.3
<i>winter</i>						
composted FYM (wi)	22.1	6.69	0.63	16	8.70	34.3
anaerobically stored FYM (wi)	21.2	6.31	0.43	15	8.20	22.4

*Table 1.*  
*Composition of the farmyard manure and mean temperature inside the manure heaps*

One heap was composted aerobically, which means it was turned seven times during the storage period. The turning was performed by hand. The large open-dynamic-chamber was built up over the compost and collected the emissions during and after the turning. The other heap was stored anaerobically. No manipulations were performed during the storage period.

After the storage period the large open-dynamic-chamber was built up on grassland and the composted and the anaerobically stored FYM were spread in the chamber. The amount of spreaded manure was equivalent to 20 t/ha. Emissions during and after spreading were also measured so that the sum of emissions (storing, turning and spreading) could be determined. The spreading of the summer trial was performed in September 1996. The temperatures were low during the spreading of the farmyard manure (10°C). The farmyard manure from the winter trial was spread at the beginning of June 1997 under warm conditions (20°C).

### 3. Results

#### 3.1. Emissions during storage and after spreading of farmyard manure.

Table 2 shows the ammonia emissions during storage and after spreading of composted and anaerobically stored FYM from the summer and winter trials. Ammonia emissions after spreading are given in reference to the amount of farmyard manure at the beginning of the storage period to make a comparison possible between the different trials and the different ways of ammonia losses.

In both trials the compost emitted more NH<sub>3</sub> than the anaerobically stored FYM. However NH<sub>3</sub> emissions from the winter compost were much lower than from the summer compost. This was due to heavy snowfall at the beginning of the winter storage period. The snow fell on the warm heap, melted and drained into the compost. Thus the oxygen supply inside the heap was very low and the composting process did not proceed well. The low temperatures inside the winter compost (table 1) also show, that due to the high water content the composting was not optimal. At the end of the storage period the winter compost was not crumbly and fragrant, but muddy and evil-smelling.

	NH <sub>3</sub> -losses [g NH <sub>3</sub> /t FM <sup>a</sup> ]			Sum
	Storage	turning	spreading	
composted FYM (su)	643.3	27.2	—	670.5
anaerobically stored FYM (su)	162.7	—	85.3	248.0
composted FYM (wi)	302.6	—	—	302.6
anaerobically stored FYM (wi)	46.2	—	197.3	243.5

<sup>a</sup> FM = fresh matter

*Table 2.*  
*Ammonia losses during storage and after spreading of composted and anaerobically stored farmyard manure*

After spreading of the compost no ammonia emissions were detectable. This corresponds well to the results of MENZI ET AL. (1997) who found a correlation between ammonia emissions and NH<sub>4</sub>-N content and lower ammonia emissions from strongly decomposed FYM than from fresh farmyard manure. The summer and the winter compost did not contain any NH<sub>4</sub>-N at the end of the storage period and therefore no NH<sub>3</sub> was emitted after spreading.

A considerable part of the ammonia emissions from the anaerobically stored FYM did not occur during storage, but after spreading. In the summer trial about 35% of the total NH<sub>3</sub> emissions emitted after spreading, in the winter trial this share amounted to 81%. The following explanations can be found for this phenomenon: The summer farmyard manure was spread in September under relatively cold weather conditions and at a very low wind speed. Both factors reduce ammonia losses after spreading. The winter farmyard manure had a high water content that led to low NH<sub>3</sub> emissions during storage. The spreading was done at the beginning of June under warm weather conditions and at a wind speed of about 0.4 m/s. The ammonia emissions from the summer trial corresponded to 2.8 kg NH<sub>3</sub>/ha, those from the winter trial to 5.74 kg NH<sub>3</sub>/ha. The first value is very low compared to emissions found by other authors due to the conditions explained before. The second value corresponds well with data from the literature. MENZI ET AL. (1997) found mean NH<sub>3</sub> emissions of 52% of the spreaded NH<sub>4</sub>-N. CHAMBERS ET AL. (1997) give NH<sub>3</sub> emissions after spreading of cattle FYM of 8.6 kg NH<sub>3</sub>/ha. This value is higher than that found in our investigations probably due to the higher application rate (30.6 t/ha).

Table 3 shows the total N losses of composted and anaerobically stored FYM from the summer and winter trials. The sum of N emissions results from gaseous NH<sub>3</sub> and N<sub>2</sub>O emissions and from liquid N emissions in the seepage water (NO<sub>3</sub>, NH<sub>4</sub>).

The total N emissions of all trials showed no major differences and amounted to 6.47-10.84% of the N content of the farmyard manure at the beginning of the storage period. However the distribution of the emissions to the investigated sources differed considerably. This shows the importance of measuring all sources of N emissions if the ecological impact of the treatments is to be evaluated.

	N losses [g N/t FM <sup>a</sup> ]			Sum	% of total N
	NH <sub>3</sub> -N	N <sub>2</sub> O-N	N in sea-page water		
composted FYM (su)	552.2	23.9	141.5	717.6	10.84
anaerobically stored FYM (su)	205.7	36.5	260.1	502.3	7.79
Composted FYM (wi)	249.2	30.0	200.1	479.3	7.60
Anaerobically stored FYM (wi)	201.3	55.6	181.9	438.8	6.47

<sup>a</sup> FM = fresh matter

*Table 3.*  
*N losses during storage and after spreading of composted and anaerobically stored farmyard manure*

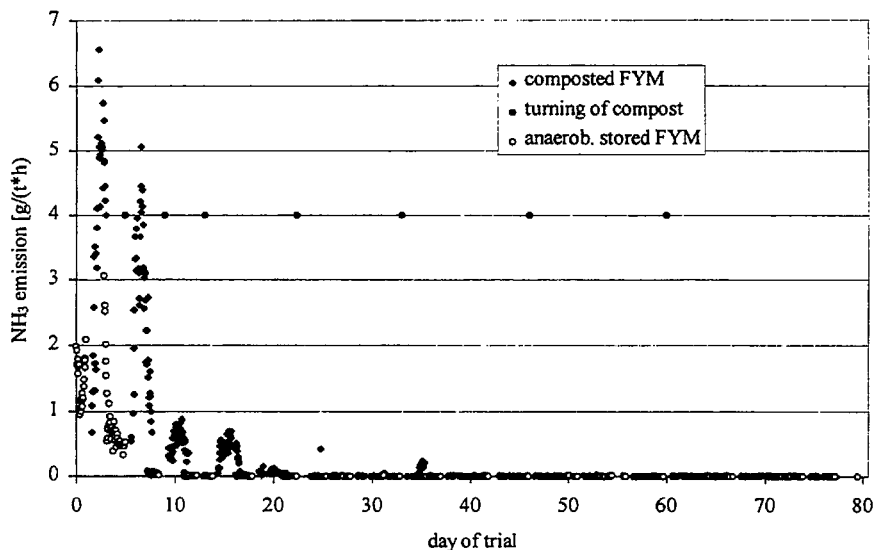

*Figure 1.*

*Course of NH<sub>3</sub> emissions from composted and anaerobically stored FYM (summer)*

NH<sub>3</sub> emitted mainly at the beginning of the storage period. Figure 1 shows the ammonia emissions from composted and anaerobically stored FYM (summer). Emissions were high at the beginning of the storage but decreased rapidly. This course of emissions was observed also from the winter trials, but NH<sub>3</sub> emissions stayed on a lower level than during the summer trials (table 2).

The course of CH<sub>4</sub> emissions differed from the course of ammonia emissions (fig. 2). CH<sub>4</sub> emissions from the anaerobically stored FYM kept on a high level throughout the whole storage period. The decrease of CH<sub>4</sub> emissions in course of the storage period was slow and they were still detectable at the end of the trial. That means that if the anaerobically stored FYM had been stored for a longer time, the sum of emissions would have increased. CH<sub>4</sub> emissions from the compost were always low.

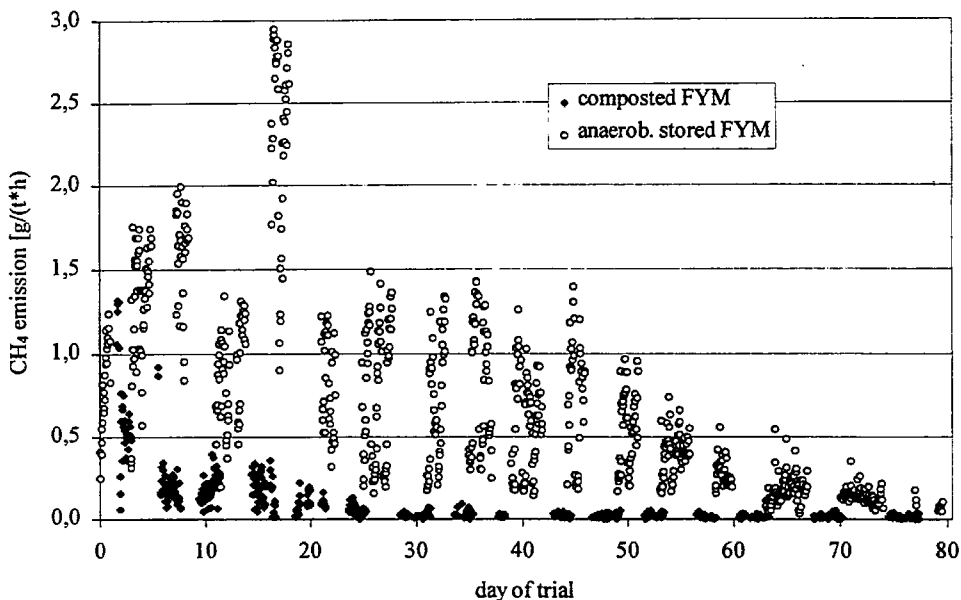

Figure 2.

Course of CH<sub>4</sub> emissions from composted and anaerobically stored FYM (summer)

As a part of the N emissions is lost via the seepage water, the seepage water should be collected. Most of the liquid N losses emitted at the beginning of the storage. Therefore farmyard manure should at least in the beginning be stored on concrete slabs with the possibility of collecting the seepage water. This would be an easy possibility to avoid a considerable part of the N losses during storage of farmyard manure.

In table 4 the sum of greenhouse gas emissions from composted and anaerobically stored solid manure are shown. To compare the global warming potential of the two treatments, N<sub>2</sub>O and CH<sub>4</sub> emissions are given in CO<sub>2</sub> equivalents, that means relative to the global warming potential of CO<sub>2</sub> (EK 1995).

	Greenhouse gas emissions [kg CO <sub>2</sub> equiv./t FM <sup>a</sup> ]		
	N <sub>2</sub> O emissions	CH <sub>4</sub> emissions	Sum
composted FYM (su)	8.87	4.96	13.83
anaerobically stored FYM (su)	13.65	47.85	61.49
composted FYM (wi)	12.27	24.21	36.48
anaerobically stored FYM (wi)	20.64	18.41	39.05

<sup>a</sup> FM = fresh matter

Table 4.

Greenhouse gas emissions of composted and anaerobically stored farmyard manure



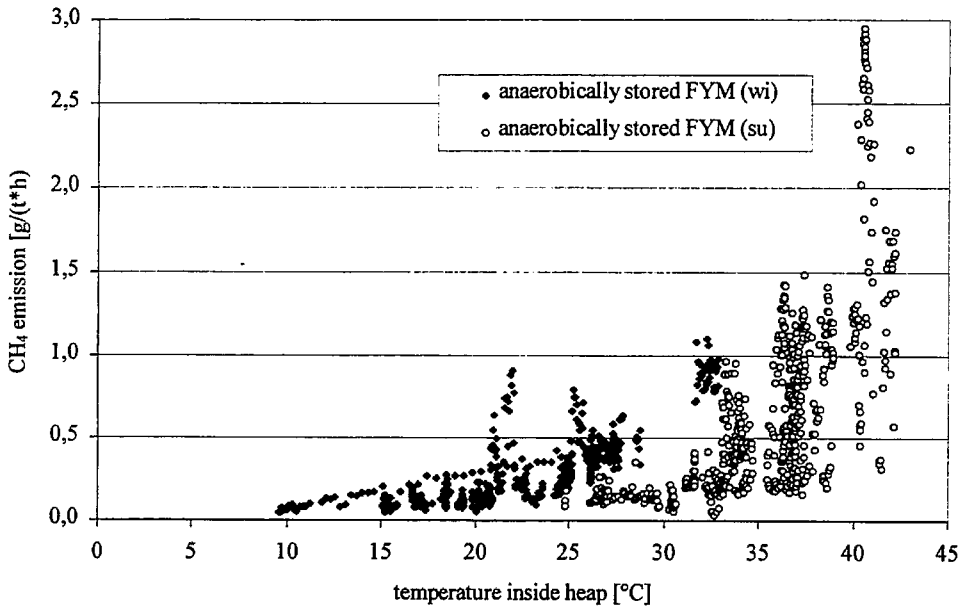

Figure 3.

*Dependency of CH<sub>4</sub> emissions from anaerobically stored FYM (su and wi) on the temperature inside the manure heap*

Greenhouse gas emissions from the anaerobically stored FYM (su) were about 4.5 times higher than from the composted FYM (su). Methane emissions contributed about 78% to the total emissions. Methane is formed under anaerobic, warm conditions when degradable C is available. Conditions in the anaerobically stored FYM favoured methane production. In summer and winter trial methane emissions from the anaerobically stored FYM were observed during the whole storage period and had not come to their end by the end of storage. They were strongly dependent on the temperature inside the manure heap (fig. 3). As the temperatures in the winter FYM rose only at the end of the storage, methane emissions were lower than from anaerobically stored FYM in summer. But they should have become much higher if the storage had continued longer.

Due to the lack of oxygen supply in the winter compost, N<sub>2</sub>O and CH<sub>4</sub> emissions were higher than from the summer compost. A sufficient aeration is essential for a good composting process. Insufficient oxygen supply leads to formation of greenhouse gases.

## 4. References

- [1] AMON, B., AMON, TH., BOXBERGER, J., PÖLLINGER, A., 1999. Emissions of NH<sub>3</sub>, N<sub>2</sub>O and CH<sub>4</sub> from a tying stall for milking cows, during storage of farmyard manure and after spreading. In : Ramiran 98, Proceedings of the 8th International Conference on Management Strategies for Organic Waste Use in Agriculture, Rennes, France, 26-29 may 1998, Martinez J., Maudet M.N. (eds), FAO-Cemagref Editions, 269-277.
- [2] AMON, B., AMON, TH., BOXBERGER, J., PÖLLINGER, A., ZAUSSINGER, A. Entwicklung einer Meßeinrichtung zur Erfassung umweltrelevanter Gasemissionen. *Die Bodenkultur* 47, 4 (1997), S. 247-253.
- [3] CHAMBERS, B.J., SMITH, K.A., VAN DER WEERDEN, T.J. Ammonia emissions following the land spreading of solid manures. In *Gaseous Nitrogen Emissions from Grasslands* (Oxon, UK, 1997, Jarvis, S.C., Pain, B.F., Hrsg., CAB International, S. 275-280.
- [4] DEWES, T. Biotisch und abiotisch bedingte NH<sub>3</sub>-Emissionen während der Lagerung von Stallmist. *Agribiological Research* 49, 2-3 (August 1996), S. 203-210.
- [5] ENQUÊTE-KOMMISSION SCHUTZ DER ERDATMOSPHÄRE DES 12. DEUTSCHEN BUNDESTAGES, Hrsg. Mehr Zukunft für die Erde: Nachhaltige Energiepolitik für dauerhaften Klimaschutz (Bonn 1995), Deutscher Bundestag, Economica Verlag. Schlußbericht der Enquête.
- [6] HÜTHER, L., SCHUCHARDT, F., WILLKE, T. Emissions of ammonia and greenhouse gases during storage and composting of animal manures. In *Ammonia and Odour Control from Animal Production Facilities* (1997), EurAgEng, Hrsg., S. 327-334. International Symposium, 6.-10. October 1997, Vinkeloord, The Netherlands.
- [7] MENZI, H., KATZ, P., FRICK, R., FAHRNI, M., KELLER, M. Ammonia emissions following the application of solid manure to grassland. In *Gaseous Nitrogen Emissions from Grasslands* (Oxon, UK, 1997, Jarvis, S.C., Pain, B.F., Hrsg., CAB International, S. 265-274.
- [8] OSADA, T., KURODA, K., YONAGA, M. N<sub>2</sub>O, CH<sub>4</sub> and NH<sub>3</sub> emissions from composting of swine waste. In *Ammonia and Odour Control from Animal Production Facilities* (1997), EurAgEng, Hrsg., S. 373-380. International Symposium, 6.-10. October 1997, Vinkeloord, The Netherlands.
- [9] RÖMER, G., BOEKER, P., SCHULZE-LAMMERS, P. Ammoniakemissionen von Festmist. *Landtechnik* 49, 2 (1994), S. 72-73.

# **Ammonia emission from naturally ventilated building for dairy cows.**

*Emissions d'ammoniac issues de bâtiments bovins à ventilation naturelle.*

**Jean-Baptiste DOLLE.**

Institut de l'Élevage. 56, Avenue Roger Salengro.

62051 Saint-Laurent-Blangy Cedex. France.

E-mail : [arras.inst-elevage@wanadoo.fr](mailto:arras.inst-elevage@wanadoo.fr)

## **Abstract**

*The current work concerns ammonia volatilisation in French naturally ventilated housing systems for dairy cows. Measurements of ammonia emissions require the determination of ventilation rate and concentration of air pollutant leaving the building. For measuring the ventilation rate, we have used a technique based on tracer gas, helium and developed a new model to predict ventilation with meteorological and animal parameters. The ammonia measurements were continuously made by a bubbling method and an infrared photoacoustic spectrometer. At the same time, we have tested an electrochemical sensor and made selectively measures with indicator tubes. The experiments realised on different buildings have shown the difficulties to appreciate the ventilation rate ranging between 600 and 2500 m<sup>3</sup>/cow/h in naturally ventilated buildings. The average ammonia concentration is included in 0.5 to 8 ppm and the emissions are contained between 3 to 8 kg/cow/seven months housing.*

## **Résumé**

Le présent travail concerne la mesure des émissions d'ammoniac issues de bâtiments bovins naturellement ventilés en France. Les mesures sur les émissions d'ammoniac exigent la détermination du flux d'air et de la concentration en polluant atmosphérique quittant le bâtiment. Pour la mesure des flux d'air, nous avons utilisé une technique basée sur le gaz traceur hélium et nous avons développé un modèle qui prédit la ventilation en fonction de paramètres météorologiques et liés aux animaux. Les essais réalisés sur différents bâtiments ont montré la difficulté d'apprécier les taux de ventilation qui varient entre 600 et 2500 m<sup>3</sup>/vache/heure dans les bâtiments naturellement ventilés. La concentration moyenne en ammoniac est comprise entre 0,5 et 8 ppm et les émissions correspondantes s'établissent entre 3 et 8 kg/vache pour les 7 mois de stabulation.

## **1. Introduction**

A large part of ammonia emissions is due to livestock farming activities : housing, storage, spreading and grazing are the four sources of ammonia which represented respectively about 35 %, 20 %, 40 % and 5 % of the emissions.

The losses result of the fast conversion of the urea by a faecal enzyme : urease. The process takes place when urine is in contact with manure on polluted floors. The contribution of emission depends on several factors : types of housing, manure management, ventilation system, storage type, spreading equipment...

This study concerns the first part of the manure handling : buildings with natural ventilation system for dairy cows. The aims are to measure ammonia level, to quantify the volatilisation and to show the influence of different parameters in housing systems without modifying breeding conditions.

Our investigations leded in different buildings with many big equipments (spectrometer, ...) and heavy method (tracer gas) have an another focus : comparing several methods, judging their performance and accuracy for at least developing a straightforward model to estimate ventilation rate, measure ammonia concentration and so, ammonia emissions.

## **2. Material and methods**

### **2. 1. Housing**

Measures were carried out in four housing systems with dairy cows :

- loose cubicle housing with concrete floor,
- loose cubicle housing with slatted floor,
- loose straw bedded housing with a concrete feeding area,
- loose straw bedded housing with a slatted floor feeding area.

These building are equipped with an open ridge and space boarding on sides for natural ventilation. The open areas and the soil surface respect the recommendations per cow.

### **2. 2. Equipment and variables measured**

The measure of ammonia emission needs to determine the ammonia concentration and the ventilation rate. If it is easier to measure the gas concentration, the estimation of the ventilation for this type of building is very difficult. The air inflow and outflow are mixed and the air flow rate is the result of the chimney effect and wind effect.

#### **□ Ventilation rate measurements**

Two techniques have been developed to estimate ventilation rate :

↳ tracer gas method with helium,  
↳ prediction model now of being developed by J. CAPDEVILLE (Institut de l'Elevage).

Tracer gas method consist to follow concentration of a gas during a laps of time to estimate the airflow in the building. The gas tracer helium is broken up in the building with a jetflow (ventury system). Taking air are realised through eight flexible tubings disposed in the building. A sample of average air is analysed in a spectrometer to detect instantaneously the evolution of helium concentration and estimate ventilation rate.

The prediction model, unlike some theoretical models proposed in order to predict the air flow rate in naturally ventilated buildings, we chose to consider that some of the mains parameters involved in the calculations can't be known with a sufficient accuracy. It seems easy to measure the areas of the inlets and the outlets and to put them into the model, but the actual active surface is impossible to determine ; in fact, only a part of the areas is active and this part depends on the shape of the openings themselves, but also on the speed and the direction of the wind. Similarly, the total heating you must take in account in the calculations isn't only produced by the cows but also by the straw bedded lying areas and by the sun shine on specific conditions. So, in order to be able to apply the model to measurements in farm situation, we considered that we only could try to explain how the ambient conditions measured inside the building were obtained according to the conditions outside, and the knowledge we had of the principles of the natural ventilation.

The best indicator of the flow rate is the difference of water content of the air between outside and inside. This difference can easily be calculated with the measurement of the temperature and the relative humidity. If the model gives a value of the water vapour produced by all the activities in the building with a sufficient accuracy, you can evaluate the flow rate which permitted to reach the values you measured for temperature and humidity inside the building.

The principle is to proceed with an iterative calculation (increasing progressively the area of the openings and the additional sources of heating) till the difference between predicted and measured values becomes very small (neglectible). Then we extract from intermediate parameters some interesting informations like the flow rate or the ratio between stack effect and wind effect and so on ...

So this model needs to have sensors inside and outside the building. Inside we record continuously temperature and humidity and outside a meteorological station save data on temperature, humidity, wind speed and wind direction.

The prediction model in process gives results with an accuracy around 10 to 20 % compared with the ventilation rate measured. This model easy to use, with simple parameters, must be improved to increase accuracy.

### □ Ammonia measurements

Four techniques have been used to measure ammonia concentration :

- ↳ bubbling method,
- ↳ infrared photoacoustic spectrometer,
- ↳ electrochemical sensor,
- ↳ indicator tubes.

The bubbling material and the infrared photoacoustic spectrometer are connected to the flexible tubings used to measure helium.

The electrochemical sensor is linked to a data logger for a continuously measurement of ammonia concentration. One measure a day is made with indicator diffusion tubes (GASTEC and DRAGER) to compare with electrochemical value and correct if necessary.

Bubbling is consider the reference method. In comparison with this reference, spectrometer and electrochemical measurements give results with an accuracy around 10 %.

## **3. Results**

The experiments have been made in 1997 and 1998 during the winter over one to four days. The measures realised on the seven buildings are not enough numerous to compare housing systems with or without straw, with or without slatted floor... Tendencies discovered here have to be confirmed with further measurements.

### **3. 1. Ammonia and temperature**

The ammonia concentration represented on figure 1, varies the whole day. On a three days period in winter, the ammonia level is comprised between 1 and 8 ppm. Meteorological conditions during this experiment, with large daily temperature variation and no wind, permit to judge the influence of inside temperature level on ammonia concentration.

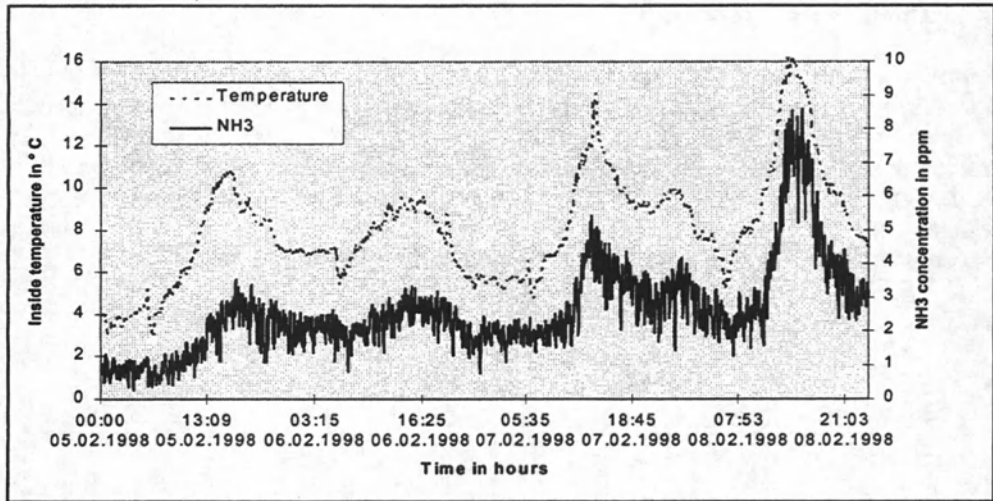

*Figure 1  
Temperature influence on ammonia concentration in condition without wind*

A similar building in another period is represented on figure 2. The daily temperature variation between 8 to 16°C for the two days period has apparently a smaller effect on ammonia concentration comprise between 0.40 and 1.20 ppm. This observation is due to meteorological conditions, the wind of 5 m/s creates a big air renewal which hides temperature effect.

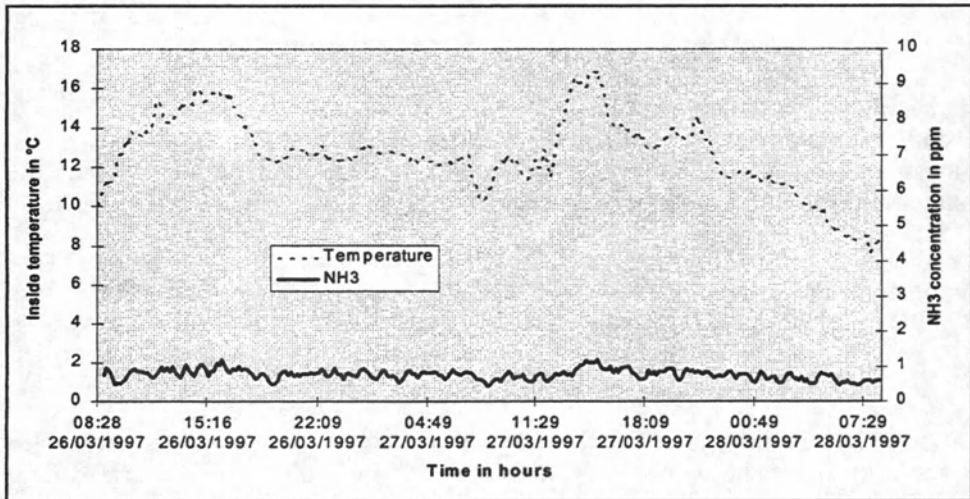

*Figure 2  
Temperature influence on ammonia concentration in condition with a wind of 5 m/s.*

### 3. 2. Ammonia and mixing

An observation over three days in a building with slatted floor is represented on figure 3. Like in the previous experimentations, we see the temperature incidence on ammonia levels. After one month without mixing the farmer begins mixing with a tractor the 18th March 98 at 11.00 a.m. during six hours and the 19th March at 10.30 a.m. during seven hours for a spreading the 20th. In comparison with the 17 March, day without mixing, we can see the mixing incidence on the ammonia concentration, in approximately the same meteorological conditions.

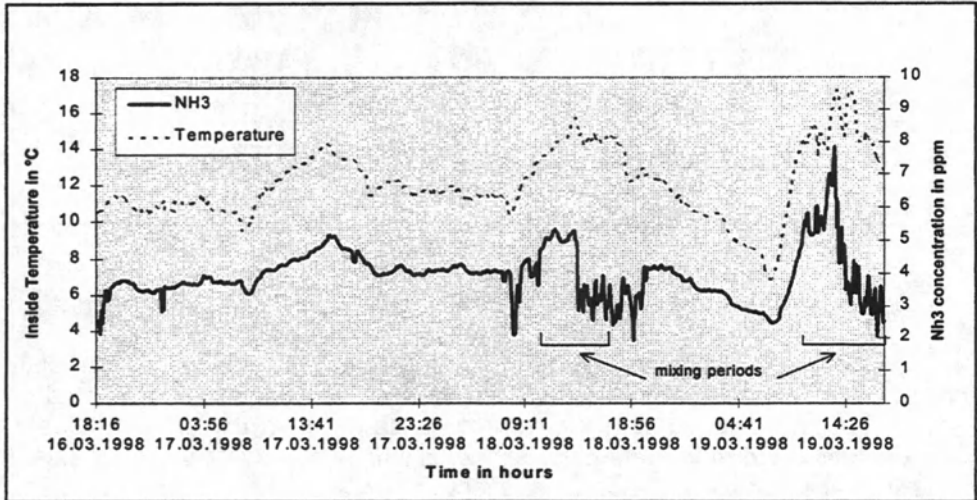

*Figure 3*  
*Incidence of mixing on ammonia concentration*

First we observe an ammonia concentration increase after the beginning of mixing. Second, about three hours later, the ammonia level decreases rapidly and becomes stabilised till the end of mixing and a laps of time after. Later the ammonia concentration gets back into a normal level.

This phenomena provokes questions. The mixing seems to contribute rapidly to the ammonia volatilisation of the ammoniacal nitrogen while stocks last. Then mineralization restocks ammoniacal pool and volatilisation becomes stabilised.

### 3. 3. Ventilation rate

The tracer gas method, used in different buildings with different weather conditions, permitted to determine ventilation rate in the range of 600 - 2500 m<sup>3</sup>/cow/h. This ventilation range depends on building width and building structure, in situation without wind. In another meteorological conditions, it depends on building orientation too.



With the high ventilation rate (table 1), ammonia concentrations are smaller. This reduction of ammonia level can be explained by the rising dilution of ambient air with clean air. Inversely for low ventilation rate, ammonia levels are not always the highest. In this case, effect of housing system and inside temperature on volatilisation are more significant.

	Ventilation rate m <sup>3</sup> /cow/h	NH <sub>3</sub> concentration ppm	NH <sub>3</sub> emissions kg/cow/7 months housing
High ventilation rate	1000 - 2500	0.50 - 1.20	6 - 8
Low ventilation rate	600 - 1000	1.00 - 4.00	3 - 6

*Table 1  
First results on ammonia emission measurements except mixing period.*

### 3. 4. Emissions

The ventilation has an effect on ammonia level in housing. So to estimate the emissions we must use the values obtained in the same building at the same time. With these elements, ammonia emissions are in the range of 3 - 8 kg/cow/ seven months housing (table 1). With this seven experiments, we can't make a correlation between these emissions and the housing system, because the weather conditions are very different. But a comparison with data published in bibliography shows that emission rates calculated in this study are in the same range.

## 4. Conclusion

**4.1.** In naturally ventilated buildings for cattle, we can't control meteorological conditions, but it's important to know factors which influence ammonia volatilisation. Our investigations allowed us to determine the influence of environmental factors on ammonia emissions.

**4.2.** In our conditions, ambient temperature has a big effect on ammonia concentration. Inversely, wind and high ventilation rate contribute to decrease ammonia concentration but generate the biggest emission into atmosphere.

**4.3.** Farmer activities have an incidence on ammonia volatilisation too. The effect of mixing is very important on ammonia concentration in ambient air.

**4.4.** These observations made on 7 buildings have to be confirmed and need further investigations on this subject.



## **Comparison of ammonia losses under various conditions after organic fertilization**

*Comparaison des pertes par volatilisation sous différentes conditions  
lors d'épandages de fertilisants organiques.*

**Génermont\*, S., Flura, D., Cellier, P.,**  
Institut National de la Recherche Agronomique,  
Unité de Recherches en Bioclimatologie, F-78850 Thiverval-Grignon, France  
E-mail : genermon@bcgn.grignon.inra.fr

### **Abstract**

*Farm effluents are applied to land to supply plant mineral nutrients requirements. Ammonia volatilization decreases their N fertilizing value. Experiments were carried out using three wind tunnels where soil and environmental conditions can easily be controlled. Seven experiments were conducted to characterize the influence of the soil surface conditions on volatilization. Four of them were devoted to soil cultivation, before, during and after spreading. We focussed on the effect of the proportion of slurry really incorporated into the soil. In three other experiments, the effect of the soil surface temperature was studied. It was thus shown how measurements using wind tunnels help understanding the agricultural techniques and environmental conditions influence on ammonia volatilization.*

Keywords: Ammonia volatilization, Wind tunnel, Slurry, Sewage sludge, Surface management

### **Résumé**

Les effluents d'élevage sont épandus au sol afin de fournir les besoins nutritifs indispensables aux plantes. La volatilisation de l'ammoniac diminue ainsi ce pouvoir fertilisant. Des essais ont été effectués à l'aide d'un système de trois tunnels de ventilation. Sept expérimentations ont été menées afin de préciser l'influence des conditions à l'interface sol-surface sur la volatilisation. Quatre essais portaient sur les sols cultivés, avant, pendant et après épandage. Nous nous sommes intéressés à l'effet de la proportion de lisier réellement incorporé au sol. Dans les trois autres essais, l'effet de la température à la surface du sol a été étudiée. Il a été démontré que les mesures utilisant les tunnels de ventilation peuvent aider à comprendre l'effet des techniques culturales sur le processus de volatilisation

Mots-clés : volatilisation ammoniac, tunnel de ventilation, lisier, boues, gestion des déchets par épandage.

## 1. Introduction

Farm effluents have high nitrogen and phosphorus fertilizing value, and their application to land contributes to plant nutrition. However ammonia volatilization after spreading decreases their N fertilizing value. It varies greatly with soil and climatic conditions, and effluent characteristics (Jarvis and Pain, 1990). For slurries, it ranges from 0 to 100% of applied ammoniacal N. It is then difficult to predict the need for further fertilization.

All data agree and show that ammonia volatilization highly depends on meteorological conditions, and especially on temperature and wind. Spring and summer emissions are higher than autumn and winter emissions (Lauer *et al.*, 1976); it can even be zero in January and 99% in August. This is mainly due to the effect of temperature on ammonia. The relationship between air temperature and ammonia volatilization magnitude was often characterized in literature (Sommer *et al.*, 1991). However ammonia volatilization does not directly depend on air temperature, but on soil surface temperature itself.

The experiments carried out in this study were designed to provide information about the magnitude and pattern of the effects of soil surface temperature and management, on ammonia volatilization. We tried to partly reproduce agricultural techniques used for soil cultivation before or after slurry application, in order to evaluate loss reduction magnitude as a function of the depth of soil work and the more or less complete incorporation of slurry.

## 2. Materials and methods

The wind tunnel system has been described in detail by Lockyer (1984). It comprises two parts: (i) an inverted U-shaped tunnel made of transparent polycarbonate which covers the 1 m<sup>2</sup> experimental plot (0.5 x 2 m), and (ii) a circular steel duct containing an electrically powered fan. Modifications suggested by Loubet *et al.* (1999a and b) were taken into account.

Eight one-week period measurements were carried out at the INRA experimental site of Grignon (France, near Paris), from June to October 1995 and in October 1996. Ammonia volatilization after slurry spreading on bare soil, with or without soil surface plowing, was monitored by using three wind tunnels. The soil was a silty clay, with pH 8, clay content 23.7%, CEC 18.1 meq(100 g soil)<sup>-1</sup> and bulk density (0-10 cm) 1.27 t m<sup>-3</sup>. Some properties of the slurries, together with the application characteristics are given in Table 1.

	Slurries			Agricultural techniques	
	dairy cattle slurry			spreading of 80 m <sup>3</sup> ha <sup>-1</sup>	
	pH	Dry Matter (%)	NH <sub>4</sub> <sup>+</sup> -N content (g kg <sup>-1</sup> )	NH <sub>4</sub> <sup>+</sup> -N applied (kg ha <sup>-1</sup> )	Day and time (UT) of application
Exp. 1	6.1	6.4	1.110	89	07/06/95, 09h30
Exp. 2	6.5	7.1	1.284	103	26/06/95, 13h15
Exp. 3	5.6	6.1	0.640	51	11/07/95, 09h45
Exp. 4	6.2	6.2	0.999	80	27/09/95, 16h00
Exp. 5	6.5	6.8	1.537	123	16/10/95, 10h45
Exp. 6	7.8	6.2	1.273	102	10/08/95, 13h40
Exp. 7	6.7	5.0			21/08/96, 16h15
Exp. 8	6.3	7.9			08/10/96, 10h00

*Table 1*  
*Description of site and materials*

The ammonia volatilization from the area covered by the tunnel was calculated by multiplying the volume of air flowing through each tunnel by the difference between the ammonia concentrations of air entering and leaving the tunnel. Ammonia concentrations were determined at the entrance of the tunnel (one sample) and in the steel duct using a sampling system with 19 holes on three branches disposed perpendicular to the air flow, by trapping the ammonia in 50 ml of aqueous acid (0.5 g l<sup>-1</sup> NaHSO<sub>4</sub>, 2H<sub>2</sub>O). The air flow rate (4.5 l min<sup>-1</sup>) was checked by a flowmeter (Gallus 2000, Schlumberger, Reims, France). Ammonia was determined by conductimetric analysis (detector of Amanda, ECN, The Netherlands). Wind speed in the tunnels over the experimental plot was constant in all experiments (1.75 m s<sup>-1</sup>), and measured in an open vein using hot wire anemometers (8450/60/70, TSI Incorporated, Aachen, Germany).

Incident solar radiation flux densities at the soil surface in the tunnels and outside 1 m above the soil surface were measured with pyranometers (CM6, Kipp and Zonen, Delft, Netherlands). Air relative humidity was measured at the entry of the steel duct with a hygrometer (HMP35A, Vaisala, Helsinki, Finland). Air temperature at 25 cm, soil surface temperature and soil temperature at 2 cm depth were measured using 2, 6 and 4 iron-constantan thermocouples. Micrometeorological data were recorded every 5 s and averaged over 15 min intervals with dataloggers (CR10, Campbell Scientific, Shephed, UK).

For each of the eight experiments, ammonia volatilization was compared with only one factor differing between each wind tunnel.

Experiments 1 to 5 investigated the effect of slurry incorporation in the soil. Soil management was chosen in order to meet agricultural practices. Direct injection of slurry in the soil or harrowing after slurry application was observed as bringing all the slurry at a specific depth in the soil. Field observations showed that plowing or incorporating slurry in the soil using a rotavator led to mix it more or less homogeneously with the soil. The least homogeneous mixing is comparable to bringing only part of the slurry deeper in the soil, and letting a fraction of the slurry at the surface, not incorporated.

	Proportions of the surface of the slurry incorporated	Depth of ploughing	Cultivation before application	Mixing slurry with Soil
Exp. 1	0, 50, 100%	12 cm	no	No
Exp. 2	25, 50, 75%	12 cm	no	No
Exp. 3	0, 50, 100%	6 cm	yes	Yes
Exp. 4	0, 50, 100%	6 cm	yes	Yes
Exp. 5	25, 50, 75%	6 cm	yes	Yes

*Table 2*  
*Soil surface management experiments*

Two depths of plowing were used. In Exp. 1 and 2 slurry was either applied at the soil surface with no cultivation before application, or, for the fraction incorporated, soil was dug out up to the incorporation depth, slurry was applied in the bottom of the hole, and the soil was thereafter brought over the slurry. In Exp. 3 to 5 soil was cultivated before application for the fraction with slurry applied at the soil surface; for the fraction incorporated, soil was dug out up to the incorporation depth, soil and slurry were mixed together, and brought again into the hole. For the others, slurry was just applied at the surface (Table 2). The treatment with half of the slurry incorporated was a common treatment between Exp. 1 and 2, and between Exp. 3, 4 and 5, and is referred to as the reference treatment thereafter.

Exp. 6 to 8 investigated the effect of soil surface temperature on volatilization. Different surface and sub-surface soil temperatures were obtained using two techniques (Table 3): surface temperature was either reduced by using two kinds of sunshades which reduced solar radiation in the tunnels or increased by heating the soil with electric resistances.

	Cultivation Before application	Mixing slurry with soil	Sunshades	Heating resistances
Exp. 6	No	no	X	
Exp. 7	yes	no	X	x
Exp. 8	-	yes		x

*Table 3*  
*Soil surface temperature experiments*

### 3. Results and discussion

#### 3.1. Soil surface management

The ammonia emission pattern is presented in Figure 1 for Exp. 4 and 5.

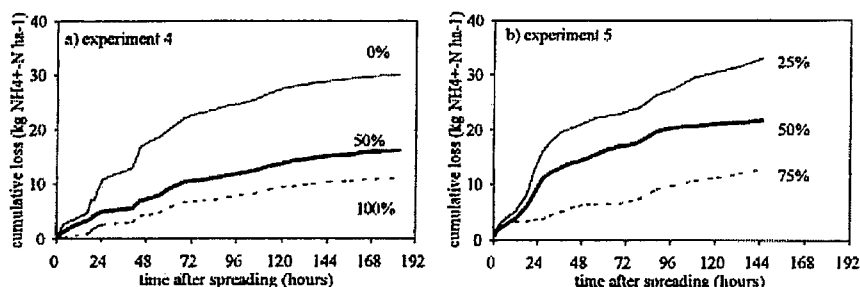

Figure 1

Ammonia volatilization (rate) following surface application of slurry to bare soil for different proportions of slurry incorporated: a) in Exp. 4 for 0% (broken line), 50% (thick line) and 100% (thin line) and in Exp. 5 for 25% (broken line), 50% (thick line) and 75% (thin line).

Agronomic and environmental conditions (Table 1 and 2) and thus the total cumulative losses (Table 4) differed greatly between experiments. Results were thus normalized and presented as the ratio of the losses measured for the different treatments to the losses of the half incorporated treatment (reference) in the corresponding experiment (Table 4).

All the experiments evidenced that slurry incorporation reduced significantly ammonia volatilization, whatever the technique used: either bringing a fraction of the slurry or all the slurry at a specific depth in the soil (Exp. 1 and 2), or mixing part of the slurry or all the slurry with the soil (Exp. 3, 4 and 5) over a smaller depth. The losses were greater in every experiments for surface application than for total or partial incorporation. These results are consistent with results for total incorporation quoted in the literature.

	Cumulative loss rate for the 50% incorporated treatment (of $\text{NH}_4^+\text{-N}$ applied)	Proportions of slurry incorporated reference				
		0%	25%	50%	75%	100%
Exp.1	3.3	430 %	-	100 %	-	133 %
Exp.2	28.0	-	-	100 %	50 %	-
Exp.3	54.7	138 %	-	100 %	-	66 %
Exp.4	18.6	192 %	-	100 %	-	68 %
Exp.5	17.3	-	147 %	100 %	60 %	-

Table 4

Ratio of the emission rates 140 hours after spreading of the different treatments to the emission rate of the 50% incorporated treatment of the corresponding experiment on soil surface management

Considering the fraction that was incorporated, the volatilization was all the more reduced than the incorporation was large. In the first experiment only, ammonia losses were greater for the whole slurry incorporated, than for the slurry half incorporated. But the accuracy of the measurement (Van derweerden *et al.*, 1996) was less than the difference between both treatments because of the very small losses measured (3.3 and 4.4%  $\text{NH}_4^+\text{-N}$  applied, resp.): they were thus not significantly different. Losses with no incorporation in Exp. 3 (138%) were smaller than losses of the 50% incorporated treatment in Exp. 4 (192%). This is due to the fact that the magnitude of the reduction in ammonia volatilization not only depends on the type of soil surface management, but also on the climatic conditions and slurry characteristics, which differed from one experiment to the other. This was all the more comprehensive in this case, that the total cumulative losses greatly differed between both experiments. This may also explain why losses were greater for the 100% slurry incorporated in Exp. 3 and 4, than for slurry 75% incorporated in Exp. 5, although the cumulative losses for the 50% incorporated treatments were nearly the same for both experiments. These results show how the comparison of different incorporation proportions between experiments is difficult.

However, before extrapolating these kind of results to real agricultural techniques, all incorporations techniques commonly used should be more thoroughly investigated and characterized following this way. This characterization will be achieved by intensive observations in the field after soil surface management.

### 3.2. Soil surface temperature

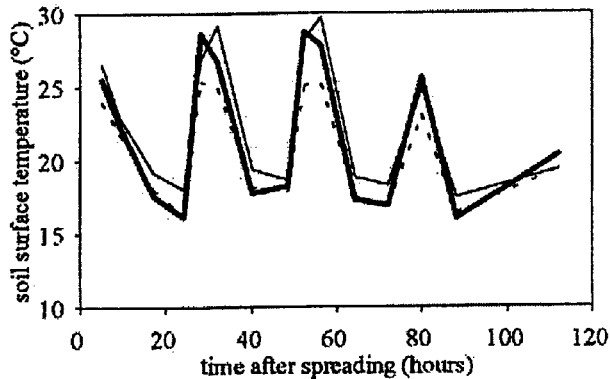

**Figure 2**  
*Variations in soil surface temperature obtained in Exp. 7, using either a sunshade (broken line) or a heating resistance (thin line) compared to the reference treatment (thick line).*



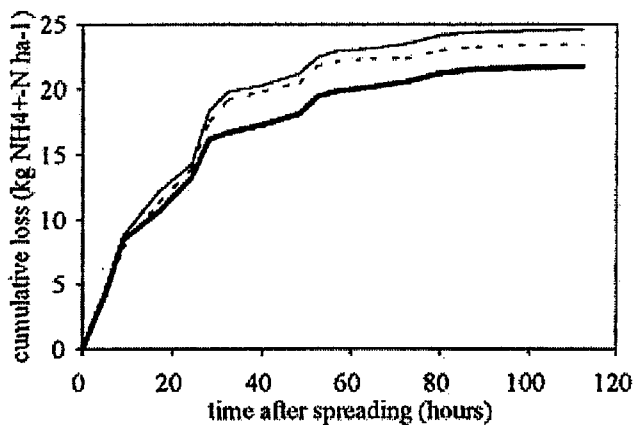

**Figure 3**  
*Ammonia volatilization in Exp. 7 for different soil surface temperatures ; cooled (broken line), or heated (thin line) compared to the reference treatment (thick line).*

Reducing solar radiation in the tunnel using two kinds of sunshades reduced significantly soil surface temperature but only during the day. The greater difference was observed near midday, where soil surface temperature differences reached 15°C on a sunny day. Heating the soil with an electric resistance increased temperatures all the day long of more than 1.5°C in one or 3°C in the other compared to the standard treatment, in Exp. 8. An example of surface temperature variations obtained by sunshade or heating resistance is given in Figure 2. It must be noticed that the energy and water budgets of the soil surface were changed together with the temperature variations, in two different ways, according to the differing effects of both techniques used.

Results of Exp. 7, combining the two techniques used to control and modify soil surface and subsurface temperatures are shown in Figure 3. Results of the three experiments are summarized in table 5. They are presented in comparison to the reference treatment (no heating, no shading).

In Exp. 7, emissions for the soil heated by using resistances were higher than emissions for the unheated reference soil. This is in accordance with all the results found in the literature showing a strong positive relationship between air temperature and volatilization (Beauchamp *et al.*, 1982; Sommer *et al.*, 1991; Moal *et al.*, 1995). But emissions for the soil cooled by using a sunshade were also greater than the reference, all along the volatilization event. All the other experiments also showed that increasing the soil surface temperature led to

decreasing ammonia emissions (table 5). These results are in opposition to what was expected: it is namely known that increasing temperatures induce increasing ammonia gas concentration in the soil gas phase, for a given ammoniacal N content of the soil (Beutier and Renon, 1978).

	Reference: Average Tsurf (°C) N cumulative loss (kg NH <sub>4</sub> <sup>+</sup> -N ha <sup>-1</sup> )	Difference to the reference Tsurf (°C) N loss (%)	
Exp. 6			
Tsurf	27.5°C	- 6.3°C	- 2.3°C
N loss	34.4	+ 104%	+ 60%
Exp. 7			
Tsurf	21.3°C	- 1.0°C	+ 0.9°C
N loss	28.5	+ 5%	+ 8%
Exp. 8			
Tsurf	13.5°C	+ 0.9°C	+ 2.6°C
N loss	21.7	- 3%	- 19%

*Table 5  
Differences in the emission rates 118 hours after spreading between  
the different treatments and the reference treatment  
(where Tsurf is the soil surface temperature)*

But other mechanisms directly implied in ammonia volatilization depend on soil temperature, like ammoniacal N transfer in the soil, adsorption to the solid phase of the soil, or soil surface drying due to evaporation, etc. And soil temperature also affects other processes reducing or enhancing ammoniacal N availability in the soil such as nitrification and assimilation of the ammoniacal N by micro-organisms, mineralization of organic N into ammoniacal N, etc. The interactive influence of temperature on these mechanisms may explain the unexpected results found here. The way surface and soil temperature act on all these mechanisms and processes should be further investigated, together with ammonia volatilization itself. This shows that such experiments have their own limitations, and need appropriate interpretation. For example, more intensive measurements in the soil and atmosphere should be performed, during all the volatilization event.

## 4. Conclusion

4.1. These data illustrated how complex a process ammonia volatilization is, and how difficult it is to separate the effect of each factor on the whole process or on each mechanism implied. They also showed that it is however necessary to separate these various specific effects. For further investigations, it would be advised to get rid of the agronomic and environmental factors also affecting volatilization but not of interest in the particular studies undertaken. Therefore measurements should be performed with the same slurry, under the same conditions: either in buildings where meteorological conditions can be controlled, or using a greater number of tunnels.

**4.2.** A greater number of data obtained with wind tunnel would help understanding the way agricultural techniques and environmental conditions influence ammonia volatilization process for research and practical purposes. Further experiments on soil surface temperature, on soil surface management, and also on soil surface initial water content, on air humidity, etc. are to be conducted, in order to clearly elucidate their effect on each mechanism implied in ammonia volatilization.

**4.3.** A mechanistic model would be necessary to objectively compare and interpret results from different experiments. It would be helpful to better understand the different ways one factor acts on ammonia volatilization and decompose interactions between factors.

**4.4.** Data from this kind of controlled experiments could be used to calibrate and validate a mechanistic model of ammonia volatilization. They would be particularly useful to check whether the model responds correctly to a change in external conditions. This could be this model which could be used in return to better understand and analyze differences between experiments.

## **5. References**

**Beauchamp E.G., Kidd G.E., Thurtell G., 1982.** Ammonia volatilization from liquid dairy cattle manure in the field. *Can. J. Soil Sci.*, 62, 11-19.

**Beutier D., Renon H., 1978.** Representation of  $\text{NH}_3\text{-H}_2\text{S-H}_2\text{O}$ ,  $\text{NH}_3\text{-CO}_2\text{-H}_2\text{O}$ , and  $\text{NH}_3\text{-SO}_2\text{-H}_2\text{O}$  vapor-liquid equilibria. *Ind. Eng. Chem. Process Des. Dev.* 17. 220-230.

**Jarvis S.C., Pain B.F., 1990.** Ammonia volatilization from agricultural land. *Fert. Soc. Proc.* no. 298. 25p.

**Lauer D.A., Bouldin D.R., Klausner S.D., 1976.** Ammonia volatilization from dairy manure spread on the soil surface. *J. Environ. Qual.* 5. 134-141.

**Lockyer D.R., 1984.** A system for the measurement in the field of losses of ammonia through volatilization. *J. Sci. Food Agric.* 35: 837-848.

**Loubet B., Cellier P., Flura D., Générumont S., 1999a.** An evaluation of the wind-tunnel technique for estimating ammonia volatilization from land : Part 1. Analysis and improvement of accuracy. *J. Agric. Engng. Res.* 72, 71-81.

**Loubet B., Cellier P., Générumont S., Flura D., 1998b.** An evaluation of the wind-tunnel technique for estimating ammonia volatilization from land : Part 2. Influence of the tunnel on transfer processes. *J. Agric. Engng. Res.*, 72, 83-92.

**Moal J.-F., Martinez J., Guiziou F., Coste C.-M., 1995.** Ammonia volatilization

following surface-applied pig and cattle slurry in France. *J. Agric. Sci.*, 125. 245-252.

**Sommer S.G., Olesen J.E., Christensen B.T., 1991.** Effects of temperature, wind speed and air humidity on ammonia volatilization from surface applied cattle slurry. *J. Agric. Sci. Cambridge*. 117. 91-100.

**Weerden van der T.J., Moal J.F., Martinez J., Pain B.F., Guiziou F., 1996.** Evaluation of the wind-tunnel method for measurement of ammonia volatilization from land. *J. Agri. Engin. Res.*, 64 (1), 11-13.

## **Stable isotopes to investigate decay processes in farm wastes.**

*Utilisation des isotopes stables pour l'étude des processus de dégradation des déjections animales.*

**Philip J Hobbs, Richard Johnson and David Chadwick.**

Institute of Grassland and Environmental Research,

North Wyke, Okehampton, Devon, EX20 2SB. UK

E-mail : phil.hobbs@bbsrc.ac.uk

### **Abstract**

*Decay rates of organic matter within farm wastes have been determined using deuterated phenol ( $d_5$ ) and acetic acid ( $d_4$ ) over a 10 day period. Production and decay rates of compounds responsible for odour and pollution were also quantified, these were the volatile fatty acids, phenols and indoles as well as methane and carbon dioxide. The relative rates of emission, bio-regeneration and bio-decay were calculated. 70% of acetic acid was lost through emission and 30% decayed within the waste to products such as methane. Regeneration was 10% of the total lost. The emission of methane was  $4.0 \text{ g l}^{-1} \text{ d}^{-1}$ . The ratio of methane generated to the decay of the acetic acid concentration was 1:66 respectively. Phenol concentration demonstrated a maximum of  $85 \text{ mg l}^{-1}$  after 175 hr. Ammonia was emitted at a rate of  $4.7 \text{ g m}^{-2} \text{ d}^{-1}$ .*

Keywords : biochemical decay processes, stable isotopes, odour production, gaseous emissions.

### **Résumé**

Utilisant le phénol deutérié et l'acide acétique on a déterminé les taux de décomposition de la matière organique dans les déjections animales (lisiers) pendant dix jours. Aussi, on a mesuré la production et les taux de décomposition de composés responsables des odeurs et de la pollution atmosphérique. Ce sont les acides gras volatils, les phénols, les indoles et aussi le méthane et l'ammoniac. On a calculé les taux d'émission relatifs ainsi que de bio-régénération. Dans ces lisiers, 70% d'acide acétique se sont dégradés par l'émission et 30% sont transformés en méthane (taux d'émission mesuré de  $4.0 \text{ g l}^{-1} \text{ d}^{-1}$ ). La proportion de méthane produit par la décomposition de la concentration d'acide acétique était 1:66 respectivement. La concentration en phénol démontrait un maximum de  $85 \text{ mg l}^{-1}$  après 175 heures. L'ammoniac s'était émis à un taux de  $4.7 \text{ g m}^{-2} \text{ d}^{-1}$ .

Mots-clés : procédés de dégradation biochimique, isotopes stables, production odeurs, émissions gazeuses.

## 1. Introduction

There decay processes in wastes that are not well described and if we are to progress in reducing emissions, then dynamic interactions involving emission, bio-decay and production of odorants should be quantified. For example, although we can measure odour and compounds emitted from the surface, we do not know the rate at which the slurry concentration may be reduced by bio-decay or increased by biological production from the slurry.

Previous investigators have noted the declining concentration of volatile fatty acids (VFAs) in pig wastes (Caunt and Hester 1989) and found it to be zero order with respect to (or independent of) concentration. Ishaque *et al* (1985) identified that degradation of phenolic compounds does not occur in anaerobically stored wastes and oxygen was required to facilitate breakdown. Phenols, indoles and branched chain fatty acids are by-products of the decay of protein (Spoelstra 1980) and it is these decay processes, that, if minimised, would reduce air pollution. These processes are therefore indicative of the magnitude of anaerobic decay or mineralisation of organic forms to inorganic forms of nitrogen and phosphorus which exists as phospholipids in viable bacteria.

Behaviour of the populations and their interactions are obviously difficult to ascertain, however the results of their actions are recognised as changes in concentration of substrate (or energy source) and the by-products. Decline of odorants due to emissions has proved difficult to measure, even when using a purpose built emissions chamber (Hobbs *et al* 1997).

Investigation of the kinetic rates as relationships between emission, bio-decay and production are of significance to waste management as we can optimise the time of spreading. We investigated these relationships using deuterated compounds and analysis by gas chromatography-mass spectrometry (GC-MS). To clarify our approach the decline of the initial concentration of odorant ( $C_0$ ) to a new concentration  $C$ , is equal to the subtraction of the emission rate (ER) and the bio-decay rate (DR), plus the production rate (PR).

$$C = C_0 - ER - DR + PR \quad \text{Eq - 1}$$

The changing concentration of an odorant in the slurry will be determined by the production rate of odorant and subtracting the emission rate and the biological decay rate. The latter two are determined by the declining concentration in the synthetic slurry, and the bio-decay rate determined from the decay of the deuterated odorant concentration in the slurry, respectively.

## 2. Materials and methods

### 2.1. Experimental design

Nine 1 litre Kilner jars (Fischer Scientific UK, Loughborough, Leicestershire, UK) contained accurately about 350 ml of finishing pigs slurry from collected beneath the slatted floors after three weeks accumulation. The volume to surface ratio was 350 cm<sup>3</sup> to 72 cm<sup>2</sup>, being about the same for the average slurry store. Equal quantities of both deuterated acetic acid-(d<sub>4</sub>) (Sigma-Aldrich Co Ltd, Poole Dorset UK) and phenol-(2,3,4,5,6)-d<sub>5</sub> (Sigma-Aldrich) were added to three Kilner jars (slurry d4d5) and the same quantities of acetic acid and phenol were added to a further three Kilner jars (slurry A&P). Three remaining slurry samples were left unchanged (slurry). Three addition Kilner jars each contained accurately about 330 mls of an artificial slurry as described in Table 1 making 12 jars in all. Air was drawn over the slurry surface at 0.6 litres min<sup>-1</sup> by an electric air pump and then through a gas meter to confirm the volume. The experiment ran for 10 days at 15 °C.

Odorant	mg l <sup>-1</sup>
Acetic acid d <sub>4</sub>	2005
Acetic acid	2070
Propanoic acid	510
2-methyl propanoic acid	505
Butanoic acid	301
3-methyl butanoic acid	104
2-methyl butanoic acid	116
Pentanoic acid	108
Phenol	66.6
Phenol d <sub>5</sub>	73.0
4-methyl phenol	68.6
4-ethyl phenol	39.2
Indole	7.3
3-methyl indole	5.9

\* Buffered to pH 8.5 with 0.880 ammonia

*Table 1*  
*Composition of artificial slurry\**

The decline of the concentration of the odorants in the synthetic slurry will give the emission rate for the individual odorants as there are no biological means of decay. The difference between the concentration decline due to emission from the synthetic slurry and the deuterated acetic acid and phenol in the slurry should give their respective bio-decay rates. Differences between the initial concentration in the real slurry (unless otherwise stated descriptions refer to the unadulterated slurry sample) and the emission and bio-decay rates should give an estimation of the production rate for this particulate set of conditions. Emission rates of other VFAs and phenols may be calculated by their changing concentration in the artificial slurry and also their summated regeneration and bio-decay by subtraction of the ER from the real slurry samples.

## **2.2. Sampling**

3.0 ml aliquots were taken from each sample every day (except weekends) for analysis by GC-MS for odorant concentration. The weight of the samples and headspace samples for quantification of ammonia, methane and carbon dioxide were taken at the same time. The pH measurement was taken every other day. Three replicate samples were taken at the beginning and the end to determine the total N, ammoniacal N (for a mass balance), dry weight (%), oil (acid hydrolysed), water soluble carbohydrate (WSC), total ash and crude fibre. Results are presented as an average of three replicates.

## **2.3. Odorant and gas analysis**

Compounds that contributed to the odour were identified by concentrating a known volume of headspace above the pig slurry (Hobbs *et al* 1996) before identification using GC-MS. Odorants subsequently identified were quantified in the slurry using GC-MS. Prior to the analysis 3 ml aliquots were centrifuged at 5000 G and 1.5 mls of supernatant was pipetted into a auto-sampler vial and 0.1 ml of 2-methyl phenol was added as internal standard.

A Hewlett Packard (hp) 5890 II Series gas chromatograph and a 5972A mass selective detector (MSD II) were used to determine odorant concentrations in the slurry samples.

## **2.4. Slurry analysis**

A range of analyses were performed, they included total nitrogen determination by the Kjeldahl method, and ammonium-N (Searle 1984). Water soluble carbohydrates, crude fibre(acid detergent), acid hydrolysed oils, pH and dry matter were also determined using methods common to food analysis.

# **3. Results and discussion**

## **3.1. Volatile fatty acids**

Exponential curves were the best expression of the declining concentrations for all VFAs from the range of samples (Fig 1), with half lives of 85 to 144 hr<sup>-1</sup> as shown in Table 2. The declining concentration rates of other VFAs was not reduced when extra acetic acid was added for both the deuterated and additional acetic and phenol replicates, indicating that declining concentration rates of acetic acid was independent from that of other VFAs.



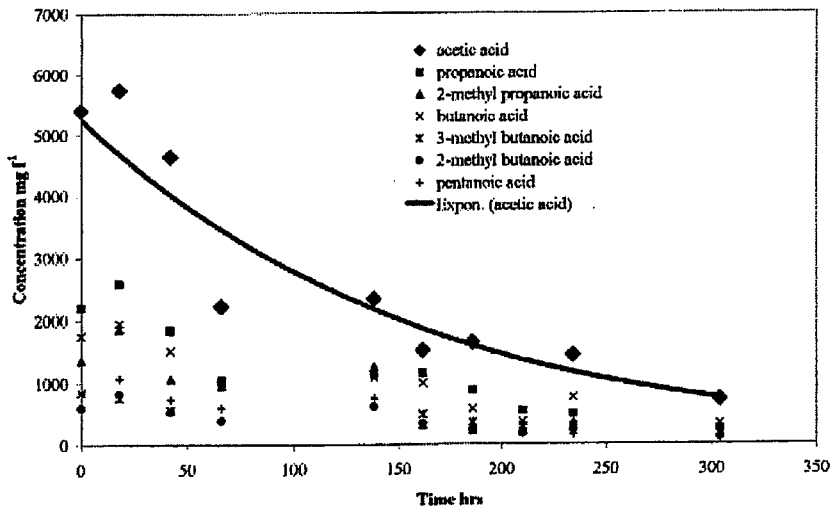

Figure 1  
Exponential decline of the VFA concentrations in slurry.

The VFA concentration time profiles were exponential indicating that the decline was concentration dependant, (Table 2) and therefore first order. This contrasts with the concentration independent, or zero order reaction mechanism identified by Caunt and Hester (1989) and Jolicoeur and Morin (1987) for acetic and propanoic acids for aerobic digestion processes. However we included the initial concentration changes which declined quickly and were significant in defining an exponential curve as the best fit (Fig 1) and no mechanical assistance was used in our experiment to improve diffusion of oxygen into the slurry. If we were to ignore the first few time periods, as did the latter authors, a zero order curve was also appropriate ( $P < 0.001$ ) for our data. However there are conditions when a pseudo-first order occurs when the substrate concentration is much less than the reaction rate (Skoog *et al* 1992). This may be the case here as our zero order reaction rates for acetic acid are  $0.0012 \text{ g l}^{-1} \text{ hr}^{-1}$  and are less than those in the publications above of  $0.176$  and  $0.033 \text{ g l}^{-1} \text{ hr}^{-1}$  respectively.

Odorant	Initial slurry concentration $\text{mg l}^{-1}$	Reaction order	Half life hrs
Acetic acid	5844	1.04	98
Propanoic acid	2484	1.08	102
2-methyl propanoic acid	1294	1.03	95
Butanoic acid	1876	0.97	126
3-methyl butanoic acid	836	0.88	144
2-methyl butanoic acid	701	0.92	124
Pentanoic acid	1047	0.97	85

Table 2  
Summary of the declining concentration rates for the volatile fatty acids

### 3.2. Acetic acid dynamics

The initial acetic acid concentration in the pig slurry was 5,800 mg l<sup>-1</sup> and this declined to 700 mg.l<sup>-1</sup>. As the initial concentrations of acetic acid varied for samples, the half-life of the exponential curves were determined and used to assess the relative concentration decline in these particular conditions. These were then used to generate a comparative graph (Fig 2) showing decline due to emission and biological function. These rates varied with time but emission was the major reason for decline (half-life of 158 hours) and bio-decay reduced the half life to 95 hours. Little, if any, production of acetic acid occurred increasing the overall half-life to 98 hours.

The reaction order was also determined for the bio-decay and emission in the slurry samples. As the declining acetic acid concentration rate was much greater than the production rate, it is appropriate to apply a differential method (Mahler and Cordes 1969) where the slope gives the reaction order and the intercept the reaction rate. There was no significant difference for the reaction order between the emission rate and the bio-decay rate with a mean of 1.02 ± 0.03. Certainly if Henry's Law was true then the emission should be concentration dependant. In addition, if the bio-decay of acetic acid was performed by enzymes either from microbial sources, or in solution, then the order should be bimolecular or pseudo-first order (Mahler and Cordes 1969). However it was surprising there was no difference between the reaction order for the two processes.

The relationship of the bio-decayed mass of acetic acid to the mass of methane was in good agreement ;

$$m = 0.015.A - 1.190 \quad \text{Eq-2}$$

(P<0.001) where A and m are the masses in mg of acetic acid and methane respectively, indicating that about 1 mg of methane was generated for every 66 mg that bio-decayed within the waste. A greater mass of carbon dioxide was produced than the amount of acetic acid that bio-decayed (1.88 mg mg<sup>-1</sup> of acetic acid) (P<0.001);

$$\text{CO}_2 = 1.88.A + 475 \quad \text{Eq-3}$$

### 3.3. Phenolic dynamics

The concentration of phenol peaked during the experiment with a maximum at 85mg l<sup>-1</sup> after 175 hours. The initial and final concentration of phenol was 30 mg l<sup>-1</sup> and 50 mg l<sup>-1</sup> respectively. Not only did the concentration have a maximum, but the initial emission and bio-decay rates were of opposite proportions to acetic acid at 10 % (0.017mg l<sup>-1</sup> hr<sup>-1</sup>) and 90 % (0.144 mg l<sup>-1</sup> hr<sup>-1</sup>) emission and bio-decay respectively, with regeneration at 1.20 mg l<sup>-1</sup> hr<sup>-1</sup> being greater than the sum of the two described means of loss at zero time.

The profile of the decline of 4-methyl phenol within the pig slurry can be described by a half life of 495 hours (P<0.100) identifying different mechanism(s) of production and/or bio-decay than those of phenol. However Ishaque et al (1985)

shows comparable bio-decay rates for the two phenols and states that the availability of oxygen is the limiting factor in phenolic bio-decay.

No significant changes in concentration were observed for 4-ethyl phenol and the indoles. Analysis of the slurry showed that the WSC had increased 6 fold for all slurry containing samples ( $P < .001$ ) suggesting that limited hydrolysis of polysaccharides had occurred. No significant changes or differences were observed between samples or during the experiment for the acid hydrolysed oil, crude fibre, total ash or dry matter content (Table 3).

Sample No	Total nitrogen g l <sup>-1</sup>	Carbohydrates W/S g l <sup>-1</sup>	Oil Acid Hydrolysed g l <sup>-1</sup>	Crude fibre g l <sup>-1</sup>	Total Ash g l <sup>-1</sup>	Ammonia nitrogen g l <sup>-1</sup>	Dry matter g l <sup>-1</sup>
Prior to experiment slurry	6.20	0.10	6.37	8.67	17.50	3.16	66.70
After experiment :							
. slurry	5.07	0.67	8.87	9.33	18.10	2.39	60.71
. slurry+acetic4 & phenol-d5	4.53	0.60	7.70	7.67	16.53	2.27	65.23
. artificial slurry	np	np	np	np	np	1.25	np
. slurry+acetic & phenol	5.10	0.67	6.70	6.00	15.10	2.76	66.01

np not performed

*Table 3*  
*Analysis of slurry contents*

### 3.4. Ammonia dynamics

Ammonia concentrations in all replicates reduced throughout the experiment. Greater rates of reduction were observed for the artificial slurry of 1.91 g l<sup>-1</sup> over the 10 day period, indicating that factors other than the VFAs are responsible for retaining ammonia in pig slurry. The initial concentration of total N and ammoniacal N in the slurry was at 6.20 and 3.16 g l<sup>-1</sup> respectively (Table 3). Over the experiment about 1.13 g l<sup>-1</sup> of N was lost and the concentration of ammonia in the pig slurry depleted by 0.85 g l<sup>-1</sup>, indicating that an additional unaccounted for organic fraction of nitrogen was lost from the slurry, most probably as ammonia.

When expressed as a surface emission, the loss of ammonia-N was 4.7 g m<sup>-2</sup> d<sup>-1</sup>, a value very similar to that of Sommer *et al* (1993). These authors measured emission rates of ammonia-N from stored pig slurry with similar total N, total ammoniacal-N and dry matter content to those used in our study during Autumn/Winter and Spring/Summer periods resulting in 3.9 and 4.6 g m<sup>-2</sup> d<sup>-1</sup>, respectively. These measurements were made from stores with a surface area and volume of 2.6 m<sup>2</sup> and 4.3 m<sup>3</sup> respectively over a 3 month period.

## 4. Acknowledgements

The authors would like to thank Ministry of Agriculture, Food and Fisheries for the funding of this work. The Pig Research Unit at The University of Plymouth for supplying the pig slurry.

## 5. References

- Caunt P, Hester K W** 1989 A kinetic model for volatile fatty acid biodegradation during aerobic treatment of piggery wastes. *Biotech and Bioeng* **34** 126-130.
- Hobbs P J, Misselbrook T H and Pain B F** 1997 Characterisation of odorous compounds and emissions from slurries produced from weaner pigs fed dry feed and liquid diets. *J Sci Food Agric* **73** 437-445.
- Hobbs P J, Pain B F, Kay R M, Lee P A** 1996 Reduction of odorous compounds in fresh pig slurry by dietary control of crude protein *J Sci Food Agric* **71** 508-514.
- Ishaque M, Bisailon J-G, Beaudet R, Sylvestre M** 1985 Degradation of phenolic compounds by microorganisms indigenous to swine waste. *Ag Wastes* **13** 229-235.
- Jolicoeur P, Morin A** 1987 Isolation of *Acinetobacter calcoaceticus* strains degrading the volatile fatty acids of swine wastes *Biol Wastes* **19** 133-140.
- Mahler H R, Cordes E H** 1969 Chemical Kinetics In: *Biological Chemistry* Harper & Row, NY pp219-228.
- Searle P L** 1984 The Bertholot or indophenol reaction and its use in the analytical chemistry of nitrogen. *Analyst* **109** 549-568.
- Skoog D A, West D M, Holler F J** 1992 Chemical methods of analysis In: *Fundamentals of Analytical Chemistry* Eds Skoog D A, West D M Holler, Saunders Publishing Orlando Florida. pp 640 -664.
- Sommer S G, Christensen B T, Nielsen N E, Schjorring J K** 1993 Ammonia volatilization during storage of cattle and pig slurry: effect of surface cover. *J Agric Sci* **121** 63-71.
- Spoelstra S F** 1980 Origin of objectionable odorous components in piggery wastes and the possibility of applying indicator components for the study of odour development. *Agric Environ* **5** 241-260.

# Emission rates of odorous compounds from pig slurries

*Taux d'émission de composés malodorants issus du lisier de porc.*

**P. J. Hobbs, T. H. Misselbrook, B. F. Pain.**

Institute of Grassland and Environmental Research,  
North Wyke, Okehampton, Devon, EX20 2SB. UK.  
E-mail : phil.hobbs@bbsrc.ac.uk

## Abstract

*Techniques to identify odorous compounds and determine their emission rates from liquid wastes using an odour emission chamber, are described. Odorous compounds, or odorants, were analysed by GC-MS and odour concentration was determined olfactometrically after emission from slurry after 6 weeks storage. We determined a range of emissions for the effects of reduced crude protein diets as compared to a commercial diet and the compounded effects of age and sex. The major odorous compounds were identified as belonging to the sulphide, volatile fatty acid, phenolic and indolic chemical groups. The mean emission rates were 1.35 million Odour Units  $\text{min}^{-1} \text{m}^{-2}$  for odour and 214, 2.15, 0.21, 0.44, 0.068 and 0.02  $\text{mg min}^{-1} \text{m}^{-2}$  for hydrogen sulphide, ammonia, phenol, 4-methyl phenol, 4-ethyl phenol and indole respectively. The effects of the sex of the pig, age and sex/diet interactions on the emission rates are discussed.*

Keywords : slurry odours, emission rates, pig, diet and crude protein.

## Résumé

Les techniques pour identifier les composés odorants et déterminer les taux d'émission de déchets liquides sont décrits. On a analysé les composés odorants ou odeurs par GC-MS et on a mesuré la concentration odorante avec un olfactomètre après l'émission des effluents utilisant une chambre d'émission odorante. On s'est procuré ces effluents de porcs qui ont ingéré une alimentation commerciale conventionnelle et une alimentation à base de protéines brutes réduite. On a identifié les composés odorants majeurs comme appartenant aux groupes sulfures, acide gras volatils, phénols et indoles. Les taux d'émission moyens des 200 litres d'effluents agités avec une vitesse d'air de 4  $\text{m sec}^{-1}$  étaient 1.35 million unités d'odeur  $\text{min}^{-1} \text{m}^{-2}$  et 214, 2.15, 0.21, 0.04, 0.068 et 0.02  $\text{mg min}^{-1} \text{m}^{-2}$  pour l'hydrogène sulfuré, l'ammoniac, le phénol, le phénol 4-méthyle le phénol 4-éthyle et indole respectivement.

Mots-clés : odeurs de lisiers, taux d'émission, porc, alimentation, protéine brute.

## 1. Introduction

Emission rates of odours from farm wastes have not received so much attention as organic compounds of environmental interest, such as hydrocarbons, halogenated hydrocarbons and poly aromatic hydrocarbons. However, at concentrations in the  $\text{mg l}^{-1}$  range  $\text{H}_2\text{S}$  and methanethiol have been fatal in many cases (Donham 1994). The emission rates from a range of anthropogenic phenols could be considered as a guide for this experiment, however, they are normally determined from natural waterways (Thomas 1990) and not a livestock slurry. Farm wastes have considerably different physical, chemical and biological properties and such analogies are difficult to justify.

In this study, we investigated pig waste using slurry from pigs fed diets containing the minimum and commercial amounts of crude protein. We also considered the age and sex of the pig on the emission rates of odorants and gases from the resulting slurry after six weeks storage. These emission rates would represent those from slurry storage facilities that have an open surface.

## 2. Materials and methods

### 2.1. Livestock and diets

Finishing (65 to 95 kg) and growing (35 to 65 kg) pigs of commercial stock were housed in groups and fed *ad libitum* the respective commercial diets (both containing 13.75 MJ digestible energy and  $11 \text{ g.kg}^{-1}$  lysine) for their age. In this comparative test, a standard commercial diet and a reduced crude protein (RCP) diet were fed to each of the age groups. As a consequence, there were two diets for the growers (G); a commercial (a) and a RCP diet (b) and also a commercial (c) and RCP diet (d) for the finishers (F). The RCP diets were obtained at the least cost according to a commercial feedstuffs database and have synthetic amino acids added. They were formulated to contain approximately same protein as the commercial diet and ratios of lysine to methionine + cystine, threonine and tryptophan at 1 to 0.6, 0.65 and 0.20 respectively. The lysine to digestible energy (DE) ratios were close to the ideal of 0.9 and 0.8 for the growers and finishers respectively (Wang and Fuller 1989). In addition, the diets contained copper sulphate (a growth promoter) at approximately 175 and 100  $\text{mg g}^{-1}$  for the growers and finishers respectively.

### 2.2. Experimental Design

Experiments were performed with pens containing pigs of different sex and age, each age was fed their respective RCP and commercial diet. There were twelve pigs in each of the eight pens, four pens contained entire males (m) and four pens contained females (f). The amount of feed offered to the pigs was 0.95 of the calculated *ad libitum* DE intake based on the pig liveweight during an acclimatisation period. The *ad libitum* DE intake, measured in MJ per day was calculated using the equation  $4.1 \times W^{0.5}$  (where W is the liveweight of the pig in kg).

Slurry was accumulated separately under each pen for one month. During month one mG were fed either diet a or b; month two mF were fed either diet c or d; month three fG were fed either diet a or b and month four fF were fed either diet c or d to acquire slurry from each diet and age group. A slurry volume of 200 litres was taken from each slurry store after thorough mixing to determine emission rates in the odours emission chamber (OEC). Emission rates for the eight slurry samples were determined to after six weeks storage under anaerobic conditions at 15°C, after four weeks accumulation beneath slatted pens.

### **2.3. Odour Emissions Chamber**

The odour emissions chamber (OEC), was designed by Cumby *et al* (1995) and has an initial headspace volume of 40 m<sup>3</sup> of air. A slurry container with a capacity of 200 litres enabled the slurry to be stirred to expose a new surface to the laminar airflow. Minimal splashing and particulate emission occurred during slurry stirring throughout the experiment. The temperature of the slurry and the air were controlled at 15 and 20°C respectively so that the higher air temperatures would minimise condensation onto the internal OEC surfaces. The OEC consists of stainless steel U-shaped ducting (0.5 m x 0.5 m internal section) whose ends were connected by a Tedlar bag. Adequate pressure was applied to the air in the OEC by the bag wrapping around a roller moving down rails under gravity to prevented external air being drawn through any leaks. This was necessary to prevent dilution of the odorants in the OEC volume.

### **2.4. Sampling and analysis of odorants**

Headspace samples were taken at seven preset time periods during the 225 minute experiment to measure odorous and non-odorous emissions by passive sampling using a Teflon FEP gas sampling bags.

Slurry samples, of 500 ml, were taken before and after the experiment for every sample for the analysis of the usual parameters, including pH, ammonium-N, nitrate-N, total N and solids and the odorants were quantified by GC-MS analysis.

Volatile compounds were concentrated from a 600 ml sample of the headspace volume above the pig slurry by adsorption onto silica (Orbo 52, Supelco Inc. Supelco Park, Bellefonte, PA, 16823-0048 USA) and carbon (Orbo 32) based adsorbents. The concentrated odorants were then thermally desorbed from the adsorbents into the GC-MS system for identification and quantification.

Liquid or slurry samples were stored at 3°C and analysed within three days of arriving at the laboratory to minimise the likelihood of further or different microbiological processes occurring. An accurate standard of each odorant in a mixture was prepared in distilled water with the pH adjusted to 8.3 and used for calibration (also stored at 3°C). Samples volumes of between 50 and a 100 ml of slurry were centrifuged at 5000 G for 30 minutes. The concentration of selected odorants was determined by the direct injection of 0.5 µl of supernatant liquid from the centrifuged slurry sample into the GC-MS system.

A Hewlett Packard (hp) 5890 II Series GC and a 5972A mass selective detector (MSD II) were used to analyse all the samples. A fused silica (cross linked methyl siloxane) hp-1 column (25 m; i.d. of 0.2 mm and a 1.00  $\mu\text{m}$  film) with a 1 m deactivated fused silica guard column was employed to analyse the sulphide component. A hp-1 column with a film thickness of 0.34  $\mu\text{m}$  was used to analyse the headspace and slurry samples. Retention time was used to identify odorants and confirmed by matching the mass spectra with that from the NIST library.

Non-odorous methane and carbon dioxide emission rates were determined by GC-flame ionisation detection and infrared spectroscopy respectively.

The olfactometric response was determined using dynamic dilution. Each olfactometer had two sniffing ports and was of the forced choice type, with odourless air being presented to the panellist through one port and diluted odorous air through the other as described in Hobbs *et al* (1995).

## 2.5. Operational and computational parameters

The effects of diet on odorants in the slurry, in terms of sex of pig for both age groups were determined and expressed as a difference in the concentration, usually as a quadratic equation. The emission rates were calculated at zero time of the OEC run. The reasons for this are threefold. First, suppression of emission by the mass present in the headspace would be minimal, as Henry's Law infers an increasing headspace concentration would reduce the chemical potential, or energy for emission to occur. This would not reflect the real situation where odorants are rapidly removed. Second, physical and chemical interactions with other odorants, which are polar and reactive, will unnecessarily complicate the results. Third, oxidative processes that occur in the slurry because of stirring may introduce another factor into the calculation that is difficult to evaluate. The emission rates are expressed as mass emitted per unit area.

## 3. Results

The OEC was found to function effectively when quantifying major gases to determine the emission rates. However, VFA's and skatole gave variable concentrations because they were at or below the limit of detection, even with preconcentration onto adsorbents.

Emission rates are presented in Tables 1 and 2 for growing and finishing pigs respectively. The mean and standard deviation (sd) of the emissions for all samples are presented in Table 3 to give a range of expected emissions from 200 litres of slurry with a 1  $\text{m}^2$  surface area that was replenished by stirring. The mean emission rate was 1.35 million Odour Units (OU)  $\text{min}^{-1}$  for odour and 214, 2.15, 0.21, 0.44, 0.068 and 0.02  $\text{mg min}^{-1}$  for hydrogen sulphide, ammonia, phenol, 4-methyl phenol, 4-ethyl phenol and indole respectively.



	Male		Female		Sed
	diet a	diet b	diet a	diet b	
OC in OU m <sup>-3</sup> min <sup>-1</sup>	6.17E+05	3.23E+05	5.70E+05	6.53E+05	1.77E+05
carbon dioxide	1017	1362	1224	879	57.9
methane	6.67	12.92	5.68	4.82	1.07
hydrogen sulphide	110	105	198	232	14.1
ammonia	2.69	0.35	2.37	1.25	*
phenol	0.011	0.012	0.007	0.576	0.024
4-methyl phenol	0.012	0.042	1.065	0.941	0.058
4-ethyl phenol	0.0001	0.0048	n.d.	0.1817	0.0078
indole	0.0016	0.0000	0.3790	0.0919	0.0291

Units of mg m<sup>-2</sup> min<sup>-1</sup> unless otherwise stated.

ns not significant P>0.2

\* not determined as two measurements at the end of the run were used.

**Table 1**

*Emission rates from growing pigs fed commercial (a) and RCP (b) diets*

	Male		Female		Sed
	diet a	diet b	diet a	diet b	
OC in OU m <sup>-3</sup> min <sup>-1</sup>	2.50E+06	1.04E+06	2.49E+06	2.65E+06	1.87E+05
carbon dioxide	1003	1660	757	549	49.4
methane	6.43	6.08	17.9	13.2	1.08
hydrogen sulphide	173	337	274	289	12.1
ammonia	2.79	0.87	5.85	1.04	*
phenol	0.48	0.17	0.01	0.45	0.058
4-methyl phenol	0.49	0.33	0.54	0.13	0.0341
4-ethyl phenol	0.11	0.04	0.07	nd	0.0466
indole	0.48	0.01	0.21	0.40	0.0498

Units of mg m<sup>-2</sup> min<sup>-1</sup> unless otherwise stated.

ns not significant P>0.2

\* not determined as two measurements at the end of the run were used.

nd not detected

**Table 2**

*Emission rates from finishing pigs fed commercial (c) and RCP (d) diets.*

	Emission rate	Standard deviation	min. max.	
			min.	max.
OC in OU m <sup>-2</sup> min <sup>-1</sup>	1.36E+06	1.01E+06	3.23E+05	2.65E+06
carbon dioxide	1056	352	548.7	1660
methane	9.22	4.80	4.8	17.9
hydrogen sulphide	214.7	83.9	105	337
ammonia	2.15	1.75	0.35	5.85
phenol	0.21	0.0247	0.0068	0.58
4-methyl phenol	0.44	0.397	0.0125	1.06
4-ethyl phenol	0.07	0.069	0.0001	0.182
indole	0.20	0.199	0.00001	0.475

Units of mg m<sup>-2</sup> min<sup>-1</sup> unless otherwise stated.

**Table 3**

*Range of emission rates of all pigs and diets.*

Odorants id and magnitude of concentration To establish if Henry's Law was obeyed, we looked for a relationship between the emission rate and the concentration in the slurry. For the odorants that were quantified in both air and slurry, ammonia, the VFAs, the phenols and indole showed no relationship (P>0.1). Physical and chemical parameters may affect the emission rate, with, for example, dry matter (DM) (Fig 1) ranging from 8.4 to 4 % by weight. The chemical composition of the slurries also varied. The VFA's, total N and ammonia were generally less for the RCP diets than for the corresponding commercial diets for

both age and sex of the pigs.

Relationships of individual odorants in the slurry to the olfactory response was investigated. This was linear for 4-methyl phenol [4-mp] ( $r^2=0.6509$ ,  $P<0.10$ ), described by equation 1 where x is the odour emission rate ( $\text{OU m}^{-2} \text{min}^{-1}$ ).

$$[4\text{-mp}] = 3.37e^{-5}x + 10.52 \text{ - Eq-1}$$

### 3.1. Emission rates for slurry from growing pigs

The OC, which could be interpreted as the total odorant content, as well as including the effects of non-odorous emissions on the odorous components, was shown to differ between the sexes ( $P=0.097$ ). Carbon dioxide, hydrogen sulphide, phenol, 4-ethyl phenol and indole showed a strong sex/diet interaction (Table 2). Reduction in concentration of nitrogen components in slurry from pigs fed the RCP diet was greater for male than female pigs (Fig 2). Ammonia emission rates from the slurry were lower for the RCP diet fed to pigs of both sexes (Table 2).

### 3.2. Emission rates for slurry from finishing pigs

Higher OC emission rates were observed from slurries from finishers than from growers (Table 3). Effect of diet was only evident for slurry from male pigs with a decrease in odour emission rate for pigs fed RCP diet. Generally, the emission rates of OC, hydrogen sulphide, phenol and indole all showed a sex/diet interaction. Although there was a higher OC emission rate for the slurries from the male pigs fed the commercial diet, the major odorant hydrogen sulphide was emitted at a lower rate than that from the slurry of the pigs fed the RCP diet. The other odorants demonstrated a higher emission rate from the slurry of the male pigs fed the commercial diet than the slurry of the female pigs fed the RCP diet.

## 4. Discussion

In order to determine their emission rates we require concentrations near 1 ppm(v) which are higher than those found around normal livestock practices. The aim was to determine the range of emission rates (Table 3) using slurries produced from different diets. Stirring the slurry did have effects, for example, an increasing stirring rate increased emission of odorants (unpublished data) although Cumby (1997) found that ammonia emission rates decreased with stirring. Increasing slurry temperature physically increases emissions and bacterial biogenesis of odorants. Odour emissions may be increased as more carbon dioxide and methane are produced with increasing temperature (Husted 1994) to strip the odorants from the waste.

The biogenesis of methane will generally be greater in a larger store per unit volume because the greater volume to area ratio creates a more stable and necessary anaerobic environment. Physical effects are also noticeable. Methane

was emitted quickly after biogenesis because of a low solubility, however there is evidence of some physical inhibition of emission (Hobbs *et al* 1997). In contrast the larger phenol molecule, present at about  $50 \text{ mg l}^{-1}$ , was emitted at  $0.21 \text{ mg m}^{-2} \text{ min}^{-1}$  and would take over 200 minutes to deplete assuming no regeneration. VFAs demonstrated ambiguous emission behaviour giving a variable concentration in the headspace with no discernible pattern. Phenols were at a higher concentration than the VFAs in the headspace although the phenol concentration in the slurry was less by an order of magnitude than that of the VFAs. Henry's law states that a thermodynamic equilibria exists between the concentration in the headspace and the slurry and that the chemical energy driving emissions is proportional to the concentration in the slurry. Phenols and indoles (the latter when measurable) demonstrated characteristic concentration curves increasing and commensurate with Henry's Law. However, Henry's Law applies to pure solutions rather than the complex mixture present in slurries. Electrolytes and surfactants in the form of polymeric proteins, saccharides and lipids all contribute to deviations from this law (Thomas 1990). A ratio of the concentration in the slurry to the emission rate did not reveal any consistent results, with the exception of 4-methyl phenol, due to the large variation of concentration in the headspace of several orders of magnitude.

We identified a relationship between OC and the concentration of 4-methyl phenol in the slurry despite hydrogen sulphide being the major odorant in the headspace. However, emission rates for methane were lower than expected, possibly because the methanogens which are strict anaerobes were inhibited by oxygen infusing into the slurry during stirring. Hydrogen sulphide is not highly soluble in water and additional stirring may have induced rapid biogenesis of this gas. Rapid emissions of hydrogen sulphide have been shown to cause fatalities (Donham 1994) and this set of criteria may be reproduced in the OEC.

The effects of age, sex and diet of the pig on the emission rates were varied, of the eight emission rates for the growers five showed a sex/diet interaction, in addition there was a sex effect for the OC. The finishers had four sex/diet interactions, 3 sex effects and a diet effect where methane biogenesis was reduced for the RCP diet. A common factor was that the RCP diets reduced the ammonia emission rates (Tables 1 and 2) and concentrations in the slurries for pigs of the same sex and age. This was also true of the total nitrogen content in the slurry.

## 5. Acknowledgements

We are grateful to Dr. Andrew Rook for the statistical analysis, Mr. Roger Kay, ADAS Terrington for supplying samples and MAFF for their financial support to perform this work.

## 6. References

Cumby T R Moses B, Nigro I 1995 Gases from livestock slurries: emission kinetics. *7th Int Conf agric food proc wastes* (ISAFPW) Chicago 18<sup>th</sup> June 1995

**Cumby T R** (1997) Personnel communication.

**Donham K J** 1994 Effects of hydrogen sulphide and other occupational health issues. In: *Proc International round table on swine odor control Iowa conference*, Iowa State University Press, Ames, Iowa, USA. 11-14.

**Hobbs P J; Misselbrook T M; Pain B F** 1995 Assessment of odours from livestock wastes by a photoionisation detector, an electronic nose, olfactometry and gas chromatography-mass spectrometry. *J Agric Eng Res* 60 137-144.

**Hobbs P J; Pain B F; Kay R M; Lee P A** 1996 Reduction of odorous compounds in fresh pig slurry by dietary control of crude protein. *J Sci Food Agric* 71 508-514.

**Hobbs P J; Misselbrook T M; Pain B F** 1997 Characterisation of odorous compounds and emissions from slurries produced from weaner pigs fed dry feed and liquid products. *J Sci Food Agric* 73 437-445.

**Husted S** 1994 Seasonal-variation in methane emission from stored slurry and solid manures *J Environ Quality*, 23 585-592

**Thomas R G** 1990 Volatilization from water. In: *Handbook of Chemical Property Estimation Methods*, Ed Lyman W J, Washington DC, American Chemical Society, 15-1 to 15-34.

**Wang T C; Fuller M R** 1989 The optimum dietary amino acid pattern for growing pigs. 1. Experiments by amino acid deletion. *Br J Nutr* 62 77-89.

## Source separation of human urine - nitrogen and phosphorus emissions.

*Séparation à la source de l'urine humaine - émissions d'azote et de phosphore.*

**Håkan Jönsson, Ulf Sonesson, Björn Vinnerås**  
Department of Agricultural Engineering, SLU, P. O. Box 7033, S-750 07 Uppsala, Sweden.  
Z-mail : Bjorn.vinneras@lt.slu.se

**Magnus Dalemo**  
Swedish Institute of Agricultural Engineering, P. O. Box 7033, S-750 07 Uppsala, Sweden.

**Caroline Höglund, Thor Axel Stenström**  
Swedish Institute for Infectious Disease Control, S-105 21 Stockholm, Sweden.

### Abstract

*In this paper some effects of separating the urine in a housing district with 160 inhabitants in Stockholm is studied. The urine separation is studied as a complement to the conventional sewage treatment and the reference system is the conventional sewage system without urine separation. The simulation results show that urine separation decreases the water emissions and the eutrophic effect of the sewage system even though the air emissions of  $NH_3$  and  $NO_x$  somewhat increase. During storage the indicator organisms died off and the hygienic quality of the stored urine was, with our present knowledge, considered good.*

Keywords : Phosphorus, nitrogen, emissions, simulation, energy, sewage system, urine separation.

### Résumé

Les effets de la séparation de l'urine dans un quartier de Stockholm de 160 habitants ont été étudiés. Cette séparation est étudiée en complément du système conventionnel de traitement des eaux usées qui demeure le système de référence. Les résultats de simulation montrent que la séparation de l'urine apporte une réduction des émissions et de l'effet eutrophisant comparativement au système conventionnel, bien que les émissions atmosphériques d' $NH_3$  et de  $NO_x$  augmentent dans certains cas. Au cours du stockage, les organismes indicateurs sont détruits et la qualité hygiénique de l'urine stockée peut être considérée comme acceptable.

Mots-clés : phosphore, azote, émissions, simulation, énergie, système d'eaux usées, séparation urine.

## **1. Introduction**

Eutrophication of the sea is a serious problem and Sweden has in several international treaties agreed to significantly decrease its water emissions of nitrogen and phosphorus. During the period 1986-1990 treated and untreated wastewater contributed 40% to the Swedish antropogenic emission of phosphorus to the sea and 32% to the corresponding emission of nitrogen (SEPA, 1993). Human urine is estimated to contribute 80% to the nitrogen and between 50% and 60% (depending on the amount of phosphorous detergents used) to the phosphorus found in ordinary household wastewater (SEPA, 1995), but only around 1% to its volume.

In pot experiments the plant availability of nitrogen and phosphorous in source separated human urine has been high (Kirchmann and Pettersson, 1995; Kvarmo, 1998). The concentrations of different heavy metals in the urine have also been found to be very low (Jönsson et al., 1997).

Toilets have been developed for source separating the urine. These toilets have the bowl divided into two parts, a front one for collecting the urine and a rear one for collecting the faecal material.

The objective of this paper is to show important changes in nutrient related environmental impact and resource usage following introduction of urine separation. Another objective is to indicate the hygienic quality of stored source separated urine. Environmental impacts and resource usage associated with construction and building of sewage systems are small compared to those from the running phase of the system (Tillman et al., 1996). This paper is limited to the running phase of the sewage system.

## **2. Methods**

The flows of important substances through the sewage system was modelled and simulated with the model ORWARE (ORganic WAstE REsearch simulation model) (Dalemo et al., 1997; Sonesson et al., 1997). In ORWARE, organic waste and wastewater flows are described with 43-position vectors, quantifying substances which influence treatment processes, give environmental impact or have a value. ORWARE has a hierarchic structure and consists of a collection of submodels describing different treatment processes. Submodels have been developed for waste collection and transport, sewage treatment plant, landfill and residual product transport and spreading.

## **2.1. Studied system**

The consequences of introducing urine separation as a complementary function of the sewage system of the Understenshöjden eco-village (44 apartments, 160 inhabitants) were studied. Measurement data from this village (Jönsson et al., 1997) were used for urine separation efficiency, urine analysis and flush water usage. However, while Understenshöjden treats all its wastewater, except the source separated urine, in a small sewage treatment plant of its own, the wastewater is in this study assumed to be treated by the conventional sewage system of Stockholm. In this system the active sludge process is used to remove organic matter (BOD), chemical precipitation to remove phosphorus and the nitrification, denitrification processes to remove nitrogen from the wastewater. The sludge is anaerobically digested, dewatered and part of it is spread as a fertiliser on arable land while the rest is landfilled. The percentage of the sludge used as a fertiliser varies between the years. In this study 50% of the sludge was assumed to be used as a fertiliser and 50% to be landfilled.

## **2.2. Scenarios**

The consequences of introducing urine separation was studied by comparing two scenarios :

Reference scenario : Ordinary toilets are used and all the wastewater from Understenshöjden is sent to and treated by the sewage system of Stockholm.

Urine separation scenario : The human urine is source separated. The remaining wastewater is sent to and treated by the sewage system of Stockholm.

## **2.3. Submodels**

The parameters and structure of the ORWARE model has previously been adjusted so that the waste and wastewater systems of Stockholm are well modelled (Bjuggren et al., 1998). Those parameter values and submodels were used in this study for the sewage treatment plant, the landfill and the wastewater pipe transport and the sludge truck transport and spreading. New models were developed for the urine pipe transport, urine collection tank, urine truck transport, urine storage and urine spreading. In these new models the ammonia emission with the ventilation air leaving the system was calculated, since these were of special concern in the study. For all these submodels, except emission after spreading urine, the calculation of the emission was done from the calculated ammonia content of the air above the urine solution and the assumed ventilation rate of that part of the system.

The calculations of the ammonia content in the ventilation air was done using equations from Svensson (1993).

### 3. Results

Product	Total nitrogen g/person, year	Plant available <sup>1</sup> nitrogen g/person, year	Phosphorus g/person, year
Urine	1788	1356	153
Recycled sludge	-44	-19	-71
Chemical fertiliser	-1338	-1338	-82

<sup>1</sup> Calculated as 80% of the ammonium nitrogen plus 30% of the organic nitrogen.

*Table 1.*

*Effects of urine separation system, compared to reference system, on the amounts of plant nutrients recycled to agriculture and the amount of chemical fertilisers needed for the same fertilising effect in the scenarios*

#### 3.1. Energy

The urine separating toilets only use a small amount of water, 0.1 litres, for flushing away the urine. Furthermore, this flush water is, together with the urine, collected and spread on cereal fields. Thus, the amount of wastewater entering the sewage system is decreased by approximately 14 litres per person and day. The decreased amount of wastewater means that less energy is needed for pumping and treating the wastewater (Table 2).

The collected urine solution is transported 35 km to a farm where it is stored and later spread. Fairly large amounts of energy are needed for these operations (Table 2). Thus, for the foreground system the energy balance is slightly better for the reference scenario. However, in the urine separating system chemical fertilisers are replaced by urine solution. Thus, when the background system, the production of electricity, fuels and chemical fertilisers, is taken into account, the urine separating system uses less primary energy than the reference system (Table 2).

Submodel	Energy usage MJ/person, year	Primary energy usage <sup>1</sup> MJ/person, year
Sewage pipes and plant (electricity)	-20	-56
Sewage plant (heat)	-3	-4
Urine transport and spreading (diesel)	35	39
Sum foreground <sup>2</sup> system	12	-21
Chemical fertiliser <sup>3</sup>	-64	-71
Sum fore- and background system	-51	-92

<sup>1</sup> These figures include production in the background system of the electricity and the fuels used. Electrical power generation from oil is assumed and for this a factor of 2.87 (Vattenfall, 1996) is used. This includes the production of the oil (factor 1.12). The factor 1.12 is also used for the production of diesel and oil. Oil is used for the production of heat for which an efficiency of 90% is assumed.

<sup>2</sup> The electricity and fuel production energies shown as usage of primary energy carriers are part of the background system.

<sup>3</sup> Energy usage according to Patyk (1996).

*Table 2.*

*Usage of energy and primary energy carriers by the urine separating system relative to the reference system*



### 3.2. Water emissions

In the urine separating system the load on the sewage plant is decreased with respect to nitrogen, phosphorus and wastewater volume. However, since the sewage treatment, which functions well, would remove almost all of the phosphorus anyway, the effect on phosphorus emission to the recipient is small (Table 3) compared with the amount of phosphorus separated with the urine (Table 1). The load reduction is far greater for nitrogen and the removal efficiency of the sewage treatment is lower. Therefore, the decrease of the nitrogen emission to water is approximately 100 times greater for nitrogen than for phosphorus.

Submodel	Nitrogen g/person, year	Phosphorus g/person, year
Sewage treatment plant	-663	-7

*Table 3.  
Water emissions of phosphorus and nitrogen by the urine separating system  
relative to the reference system*

### 3.3. Air emissions

The simulated emissions of ammonia for the whole system except the spreading of the urine proved to be very small. Only 0.02% (Table 4) of the nitrogen of the urine is lost as ammonia before spreading. The ammonia emission following the spreading operation is by far the greatest ammonia emission of the whole system.

The other nitrogen emission of large environmental concern is  $\text{NO}_x$ . It is produced by the internal combustion engines used for transporting the urine (Table 4). In the background system the  $\text{NO}_x$  emissions are reduced since less electricity and less chemical fertilisers are used. Still however, urine separation leads to a net increase in the emission of  $\text{NO}_x$  as well as of  $\text{NH}_3$  (Table 4).

Subsystem	Ventilation ratio	NH <sub>3</sub> pressure ratio	NH <sub>3</sub> -N emission g/person, year	NO <sub>x</sub> -N emission g/person, year
Urine pipe	2	0.5	0,06	-
Collection tank	10	0.25	0,14	-
Truck transport	1	1	0,06	16
Storage tank	1	0.75	0,10	-
Urine spreading	-	-	107	2
Sum foreground system	-	-	107	18
Chemical fertiliser and electricity production <sup>1,2</sup>	-	-	-6	-7
Sum foreground and background system			102	11

<sup>1</sup> Data from Patyk (1996).

<sup>2</sup> Data for oil power generation (Vattenfall, 1996).

*Table 4.*

*Air emissions of NH<sub>3</sub>-N and NO<sub>x</sub>-N by the urine separating system relative to the reference system. The ventilation is expressed as the ratio between the flow of air divided by the flow of urine flush water solution. The NH<sub>3</sub> pressure ratio is the ratio between actual and equilibrium pressure of NH<sub>3</sub> in the gas*

### 3.4 Hygienic quality

After four months of storage the concentrations of coliforms, faecal streptococci and E. Coli were below detection level (10 cfu/ml) (Table 5). The results of the hygienic measurements are reported in full detail in Höglund et al. (1998b).

Indicator organism	Storage days	Surface cfu/ml	Middle cfu/ml	Bottom + 5 cm cfu/ml	Bottom cfu/ml
E. coli	<10 cfu/ml at every analysis				
Coliforms	0	250	82	<10	300
	126	<10	<10	<10	<10
Faecal streptococci	0	2400	1600	610	9500
	126	<10	<10	<10	<10
Clostridia	0	64	68	97	610
	126	15	59	88	290

*Table 5.*

*Effect of storage on concentrations of indicator organisms found in source separated urine at different levels in the collection (day 0) and storage tank (day 126)*

For the urine separation scenario the air emissions are larger, both of NO<sub>x</sub> and of NH<sub>3</sub>. In some situations both these substances can cause acidification and eutrophication. The potential eutrophic effect is also affected by the water emissions. The potential eutrophic effect of the two scenarios are compared in Table 6. As can be seen the effect due to increased air emissions is small compared to that of decreased water emissions. Thus, the net effect is a clear decrease. However, the emission of nutrients were not included in the system. If these increase the net decrease will be smaller.

Subsystem	Emission g/person, year	Weighing factor <sup>1</sup>	Eutrophic effect kg O <sub>2</sub> /person, year
<b>Water emissions</b>			
Total nitrogen	-663	20	-13,3
Phosphorus	-7	140	-1,0
<b>Air emissions</b>			
NH <sub>3</sub> -N	102	20	2,0
NO <sub>x</sub> -N	11	20	0,2
<b>Total eutrophic effect</b>			<b>-12,0</b>

<sup>1</sup> Nord (1995).

*Table 6.  
Potential eutrophic effect of the urine separating scenario compared  
to the reference scenario*

The measurements from the storage tank confirmed the results of survival experiments in the laboratory (Höglund et al., 1998 a; Olsson, 1995). These have shown that at ordinary storage conditions *E. Coli* and coliforms die off fast, faecal streptococci die off within 3-6 months and clostridia is hardly affected at all. So far no bacteria, excluding clostridia spores, have been found to survive longer than faecal streptococci. Thus, our tentative recommendation in Sweden is to store the urine for six months before using it as a fertiliser. After this storage we, with our presently knowledge, consider its hygienic quality good.

## 4. Conclusions

**4.1.** Even where wastewater treatment is efficient and well functioning, as in Stockholm, the results show that urine separation leads to decreased eutrophic effect. In places where the sewage treatment is not as efficient as in Stockholm, for example in many rural settlements, the positive effect of urine separation would be greater. This effect is due to a large reduction in water emissions from the sewage system. The air emissions somewhat increase. However, the net effect is a clear reduction in the potentially eutrophic effect.

**4.2.** Source separating urine and reusing it as fertiliser proved more energy efficient than removing the nitrogen from the wastewater in the sewage plant combined with production of plant available nitrogen in a fertiliser plant. For the usage of primary energy the value of the urine as a fertiliser and the saved electricity (assumed to be produced by oil power) in the sewage system were approximately equally important. If however the saved electricity is assumed to be produced by hydropower, the importance of the saved electricity on the usage of primary energy carriers is greatly reduced.

**4.3.** Source separated urine is very suitable as a fertiliser. This study indicates, as is more fully discussed in Höglund et al. (1998a, 1998b), that the hygienic quality of source separated urine is good after being stored for six months. Other studies have also shown that the concentrations of heavy metals are low (Jönsson et al., 1996) and that the plant availability of the nutrients is high (Kirchmann &

Pettersson, 1995; Kvarmo, 1998). Thus source separated urine is well suited to be used as a fertiliser in agriculture.

## 5. Acknowledgements

This study was financed by the Swedish Farmers Foundation for Agricultural Research, the Swedish Council for Building Research, VA-FORSK (the Swedish Municipalities Sewage Research Program), the National Board of Health and Welfare and the Swedish Environmental Protection Agency. The measurements on urine separating systems necessary for the simulations were done with financial support also from Stockholm Vatten AB (Stockholm Water Limited), HSB Riksförbund (the National Organisation of HSB), AB Stockholmshem (Stockholm Housing Limited) and Stockholms Läns Landstings Miljövårdsfond (the Environmental Fund of the Stockholm County).

## 6. References

- Bjuggren, C., Björklund, A., Dalemo, M., Nybrant, T., Oostra, H., & Sonesson, U.** 1997. Systemanalys av avfallshanteringen i Stockholm (Systems analysis of the waste handling system of Stockholm). Manuscript (In Swedish).
- Dalemo, M., Sonesson, U., Björklund, A., Mingarini, K., Frostell, B., Jönsson, H., Nybrant, T., Sundqvist, J.-O. & Thyselius, L.** 1997. ORWARE - A simulation model for organic waste handling systems, Part 1: Model description. Resources, conservation and recycling 21: 17-37.
- Höglund, C., Stenström, T. A., Jönsson, H., Sundin, A.** 1998a. Evaluation of faecal contamination and microbial die-off in urine separating sewage systems. Accepted for Water Quality International '98, Nineteenth Biennial Conference of the International Association on Water Quality, Vancouver, BC Canada, June 21-26, 1998. (Water Science and Technology).
- Höglund, C., Stenström, T. A., Sundin, A., Jönsson, H. & Vinnerås, B.** 1998b. Hygienic quality of source separated urine based on the analysis of faecal indicator bacteria. In Ramiran 98, Proceedings of the 8th International Conference on Management Strategies for Organic Waste Use in Agriculture. 26-29 May 1998. Rennes. France. Martinez J., Maudet M.N. (eds). FAO-Cemagref Editions, 517-528.
- Jönsson, H., Stenström, T.A., Svensson, J. & Sundin, A.** 1997. Source separated urine - Nutrient and heavy metal content, water saving and faecal contamination. Water Science and Technology 35(9):145-152.
- Kirchmann, H. & Pettersson, S.** 1995. Human urine - Chemical composition and fertilizer use efficiency. Fertilizer Research 40: 149-154.

**Kvarmo, P.** 1998. Humanurin som kvävegödselmedel till stråsäd (Human urine as a nitrogen fertilizer to cereals). Masters thesis no 107, Department of Soil Science, SLU. Uppsala, Sweden.

**Nord.** 1995. Nordic guidelines on life-cycle assessment. Nord 1995:20. Copenhagen, Denmark.

**Patyk, A.** 1996. Balance of energy consumption and emissions of fertilizer production and supply. Preprints from the International Conference on Application of Life Cycle Assessment in Agriculture, Food and Non-Food Agro-Industry and Forestry: Achievements and Prospects, Brussels, Belgium, 4-5 April 1996.

**SEPA.** 1993. Ett miljöanpassat samhälle (An environmentally adapted society). Report 4234, Swedish Environmental Protection Agency. Stockholm, Sweden. (In Swedish.)

**SEPA.** 1995. Vad innehåller avlopp från hushåll? (What does household wastewater contain?). Report 4425, Swedish Environmental Protection Agency. Stockholm, Sweden. (In Swedish.)

**Sonesson, U., Dalemo, M., Mingarini, K. & Jönsson, H.** 1997. ORWARE - A simulation model for organic waste handling systems, Part 2: Case study and simulation results. Resources, conservation and recycling, vol. 21, pp.39-54.

**Svensson, L.** 1993. Ammonia volatilization from land-spread livestock manure. Dissertation, Department of Agricultural Engineering, SLU. Uppsala, Sweden.

**Tillman, A.-M., Lundström, H. & Svingby, M.** 1996. Livscykelanalys av alternativa avloppssystem i Bergsjön och Hamburgsund (Life cycle analysis of alternative sewage systems in Bergsjön and Hamburgsund). Report 1996:1, Section of Technical Environmental Planning, Chalmers Technical University. Gothenburg, Sweden.

**Vattenfall.** 1996. El och miljö – sammanfattande rapport (Electricity and environment – summary report).



# Estimating ammonia losses during the composting of farmyard manure, using closed dynamic chambers

*Estimation des émissions d'ammoniac lors du compostage de fumier bovin à l'aide de chambres dynamiques.*

## **T. Morvan**

Unité d'Agronomie, INRA,  
65, rue de Saint-Brieuc,  
F-35042 Rennes. France  
E-mail : morvan@rennes.inra.fr

## **P. Cellier**

Unité de Recherches en Bioclimatologie,  
INRA, F-78850 Thiverval-Grignon.  
France.

## **J. Dach**

Instytut Mechanizacji Rolnictwa P-60-  
627 Poznan.

## **Abstract**

*Few studies have been made in to quantify ammonia volatilization occurring during the composting of cattle farmyard manure (FYM), although the mass balances show that nitrogen losses during such composting may represent 10 to 40 % of the total nitrogen. Ammonia emissions were measured for 25 days using three closed dynamic chambers arranged on top of the FYM windrow. The greatest fluxes were observed during the first few hours, rising to 0.9 to 1.3 g N m<sup>-2</sup> h<sup>-1</sup>. Ammonia emissions greatly decreased, and were insignificant two days after the beginning of the experiment Ammonia emissions resumed in two chambers on days 4, 5 and 8, and were greatly stimulated after turning the heap turning, on day 11.*

Keywords : volatilization, composting, farmyard manure, dynamic chambers

## **Résumé**

Peu d'études ont été menées pour quantifier la volatilisation de l'ammoniac se produisant au cours du compostage de fumier bovin, bien que les bilans azotés démontrent que ce processus représente 10 à 40% de l'azote total éliminé. Les émissions d'ammoniac ont été mesurées durant 25 jours à l'aide de trois chambres dynamiques fermées placées au dessus du tas en compostage (andain). Les flux maximum ont été mesurés au cours des premières heures, avec des valeurs de 0.9 à 1.3 g N m<sup>-2</sup> h<sup>-1</sup>. Les émissions d'ammoniac diminuent ensuite fortement et deviennent négligeables deux jours après le début de l'essai. Ces émissions se produisent ensuite lors de chaque retournement de tas.

Mots-clés : volatilisation, compostage, fumier, chambre dynamique.

# 1. Introduction

The many benefits of composting farmyard manure have been reviewed by Le Houerou (1993). Attention is currently being focused on the environmental effects of this practice. During composting, the N content of the manure decreases with total N losses ranging from 10 to 40 % of the total nitrogen (Kirchmann and Witter, 1989, Ballesteros and Douglas, 1996). These N losses may occur via different pathways : i) the ammonia content of fresh farmyard manure may represent 5 to 20 % of the total nitrogen, part of which may be volatilized, due to high pH values and high temperatures inside the composting windrow, ii) nitrate is the end product of aerobic transformations, and may be lost through leaching, or as  $N_2O$ , through denitrification. De Bertoldi et al (1982) found that N losses were mainly due to ammonia volatilization, and were greater when turning than when aerating : similar results were obtained by Martins and Dewes (1992), who measured nitrogen losses during the composting of pig, cattle and poultry manure. These authors also pointed out that ammonia losses were mainly related to the original nitrogen concentration, temperature and heap rotation.

Most experimental set-ups consist of small farmyard heaps placed in tents or closed chambers (Inbar et al, 1990, Martins and Dewes, 1992). These designs might be criticized, because : i) ammonia losses, and other nitrogen transformations are strongly dependent on temperature and it is clear from the results of Martin and Dewes (1992) that such temperature increases are lower in small heaps, compared to those observed in a 1.5 m high windrow ; ii) gas diffusion in the upper part of the FYM heap is affected by outside air temperature and windspeed : it may therefore be supposed that the volatilization kinetics also differ depending on whether composting is carried out in a closed apparatus, or under natural conditions.

For these reasons we tested a simple apparatus which permitted measurements of ammonia volatilization during the composting of « real » cattle FYM windrows, in outside conditions, and study of the kinetics of ammonia loss.

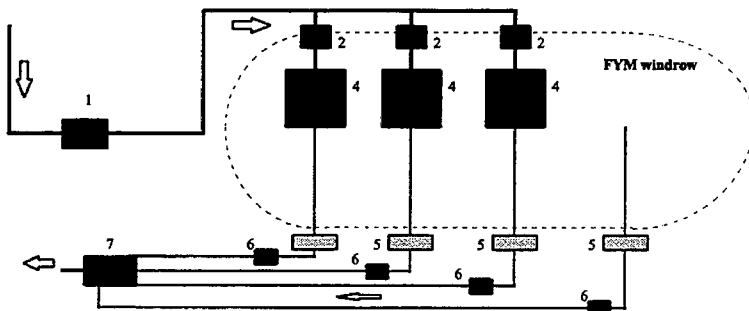

Figure 1

Diagram of the apparatus. 1 : pump ; 2 : inlet gasmeter ; 3 : chamber ; 4 : fan ; 5 : acid trap ; 6 outlet gasmeter ; 7 : pump.



## 2. Material and methods

Cattle farmyard manure (FYM), the composition of which is given in table 1, was composted in a 1.5 m high windrow ; the ammonia content of the cattle FYM was relatively high (19% of total nitrogen) and was typical of a fresh manure. Three closed dynamic chambers immediately arranged on top of this windrow. These chambers consisted in a ventilated stainless steel cover equipped with a fan for mixing the air inside. The exposed surface area of manure was 0.25 m<sup>2</sup> (0.5m x 0.5 m). The inlet air flow was 114 l mn<sup>-1</sup> and was measured with a gas meter ( $\pm 1$  l) .The ammonia concentration of the air leaving the chamber was measured by sampling at a rate of 2.8 l mn<sup>-1</sup> and driving it through absorption flasks filled with an H<sub>2</sub>SO<sub>4</sub> solution (0.072 N) and positioned near to the chambers. The flasks were sampled at intervals varying from 1 to 24 hours ; ammonia emissions were continuously measured during the first 15 days, and on days 20 and 25. Ammonia concentration was also measured in the free air just above the surface of the heap.

pH	8.5
dry matter (%)	27.5
N-NH <sub>4</sub> (g kg <sup>-1</sup> )	0.97
N <sub>tot</sub> (g kg <sup>-1</sup> )	4.99

Table 1

*Composition of the cattle farmyard manure (FYM) at the start of the experiment.*

Temperature was monitored in the windrow, using 6 thermoelements set up at 0.2, 0.5 and 0.8 m depth ; data was measured at hourly intervals and recorded on a datalogger. pH was also measured at hourly intervals during the first seven days.

## 3. Results

The temperature rose rapidly to 65-70°C during the first three days at depths of 0.50 and 0.80 m depth inside the heap, and remained constant, whereas the temperature near to the surface of the heap , measured at 0.20 m depth, was subject to variations ranging from 40-52 °C, from the second to 25 th day. pH rapidly rose from 8.5 to 9, during the first day, and then remained constant.

Temperature and pH were therefore highly favourable to volatilization.

The plots of ammonia fluxes are presented in figure 2.

- Ammonia emission was considerable during the first few hours, decreasing from 0.9-1.3 g N m<sup>2</sup> h<sup>-1</sup> to insignificant values, 30 hours after the beginning of the experiment ; these observations differ from the results of Martin and Dewes (1992), who showed that volatilization in a closed composter occurred progressively during

the first few days. The pattern of volatilization that we describe may be explained by the rapid increase of temperature which was favourable to the « production » of gaseous  $\text{NH}_3$ . The cumulative fluxes over the first four days were similar in all three chambers (  $8.3 \pm 0.8 \text{ g N m}^{-2}$  ).

- Ammonia emissions resumed on days 4, 5 and 8 in two chambers only, and in the free air measurement. These « pulses » were lower than those observed during the first few hours, and were associated with increasing temperature in the upper part of the FYM heap, which were consistent with increasing air temperature.
- Ammonia emission was strongly stimulated in chambers 1 and 2 by turning the heap, whereas low rates of volatilization were observed in chamber 3. The ammonia fluxes occurring after heap rotation were lower than those observed just after the beginning of the experiment : this was probably due to the 2.5 fold lower ammonia content of the cattle FYM, on day 11, compared to the original ammonia content.

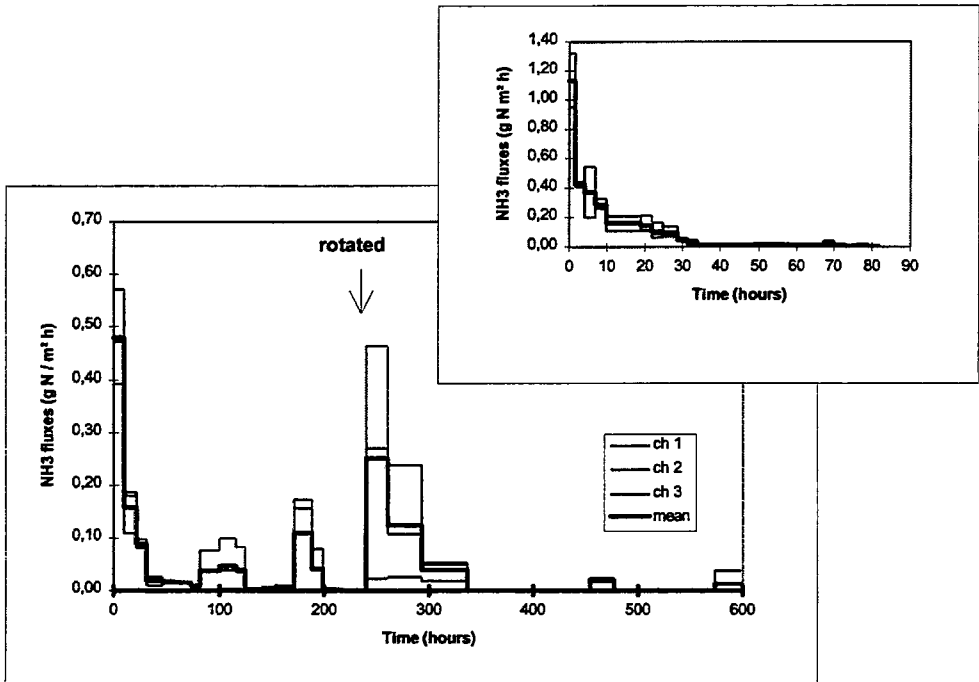

**Figure 2**  
*Changes in  $\text{NH}_3$  content in the three chambers over a 25 day period (ammonia emissions were continuously measured during the first 15 days, and measured on days 20 and 25 over the 15-25 days period)*

## 4. Conclusion

Ammonia losses during composting of FYM were related to the temperature and heap turning ; the simple set up that we used was able to show that the kinetics of ammonia volatilization during composting of « real » FYM windrows seemed to be different to those observed in small heaps placed in closed chambers. This apparatus is cost-effective and easy to maintain. Great variability was however observed between the three measuring repetitions and will require further investigation.

## 5. References

**Ballester TP, Douglas EM**, 1996. Comparison between the Nitrogen Fluxes from Composting Farm Wastes and Composting Yard Wastes. *ASAE*, 39, 1709-1715.

**De Bertoldi M, Citernesi V, Griselli M**, 1982. Microbial populations in compost processes. In *Composting*, 26-23. Emmaus, Pa : The JG Press, Inc.

**Inbar Y, Chen Y, Hadar Y**, 1990. Humic Substances formed during the Composting of Organic Matter. *Soil Sci. Soc. am. J.* 54, 1316-1323

**Kirchmann H, Witter E**, 1989. Ammonia volatilization during aerobic and anaerobic manure decomposition. *Plant and Soil*, 115, 35-41.

**Le Houerou B**, 1993. Le compostage des fumiers, une des pratiques pour protéger l'eau. Intérêts et limites de cette technique pour l'éleveur. In : *Congrès du Gemas Comifer. Matières organiques et agriculture*, 22 p.

**Martins O, Dewes T**, 1992. Loss of Nitrogenous Compounds during Composting of Animal Wastes. *Bioresource Technology* 42, 103-111.



# **Nitrogen deposition on forests and open land in regions with different livestock densities**

*Dépôts d'azote en forêts et sur terres  
dans trois régions à densité d'élevage différente.*

**G. Steffens, K. Mohr, F. Lorenz**

Institute for Agricultural Analysis and Research of the Agricultural Chamber of  
Weser-Ems, PO Box 25 49, D-26015 Oldenburg, Germany

E-mail : [steffens.lufa.lwk-we@t-online.de](mailto:steffens.lufa.lwk-we@t-online.de)

E-mail : [lorenz.lufa.lwk-we@t-online.de](mailto:lorenz.lufa.lwk-we@t-online.de)

## **Abstract**

*In the last years, a lot of experiments and investigations has been carried out on ammonia emissions from animal buildings, slurry stores and after slurry application. There is only few information available on the fate of the gaseous nitrogen after emission.*

*Measurements of nitrogen deposition rates in three regions of North West Germany, which differ in livestock density (high, middle, low), are being carried out since two years.*

## **Résumé**

Au cours des dernières années, de nombreux essais et investigations ont été conduits pour mesurer les émissions d'ammoniac issues des bâtiments d'élevage, des fosses de stockage et lors de l'épandage. Il y a pourtant très peu d'informations sur le devenir de ces composés azotés gazeux après leur émission.

Les mesures de dépôts d'azote dans trois régions du nord ouest de l'Allemagne différentes par leur densité d'élevage (élevée, moyenne, faible) ont été effectuées depuis deux ans.

# 1. Introduction

In the last decade, a lot of experiments and investigations have been carried out on ammonia emissions from animal buildings, slurry stores and after slurry application. There is only few information available on the fate of gaseous nitrogen after emission. A research project, financed by the EU and the government of Lower Saxony, should therefore answer the following questions :

- How does the ammonia N content in the air differ between areas of different livestock density?
- How much nitrogen is deposited in dependance on
  - weather conditions
  - cropping conditions (forest, edge of forest, open land)
  - livestock density
- What is the effect of the nitrogen deposition on forests with regard to
  - the growing conditions of forests
  - the botanical composition
  - nitrate leaching of soils

Measurements on nitrogen deposition rates have been running since two years in three regions of North West Germany, which differ in livestock density (high, middle, low).

# 2. Material and methods

Three regions with different levels of livestock density were investigated : high ( $> 3 \text{ LU ha}^{-1}$ ), middle ( $1.5 - 2.5 \text{ LU ha}^{-1}$ ) and low livestock density ( $1.5 \text{ LU ha}^{-1}$ ). To make the results of the investigations comparable, it was necessary to find sites similar in soil type and other ecological growth conditions. Pine forests (about 60 years old) were chosen, all located on podsollic sandy soils. In those forests and on neighbouring open land we installed a measurement equipment as shown in figure 1. The following measurements have been carried out :

- ammonia N contents in the air above the forest canopy
- biomonitoring of air pollution by exposing pots with
  - grass
  - clones of norway spruce
  - lichens
- N deposition (wet and dry) on open land and throughfall between trees
- nitrate and ammonia N contents in forest soils
- N output of forest soils
- growing conditions of pine trees (nutrient status of needles)
- floristical composition of the forests.

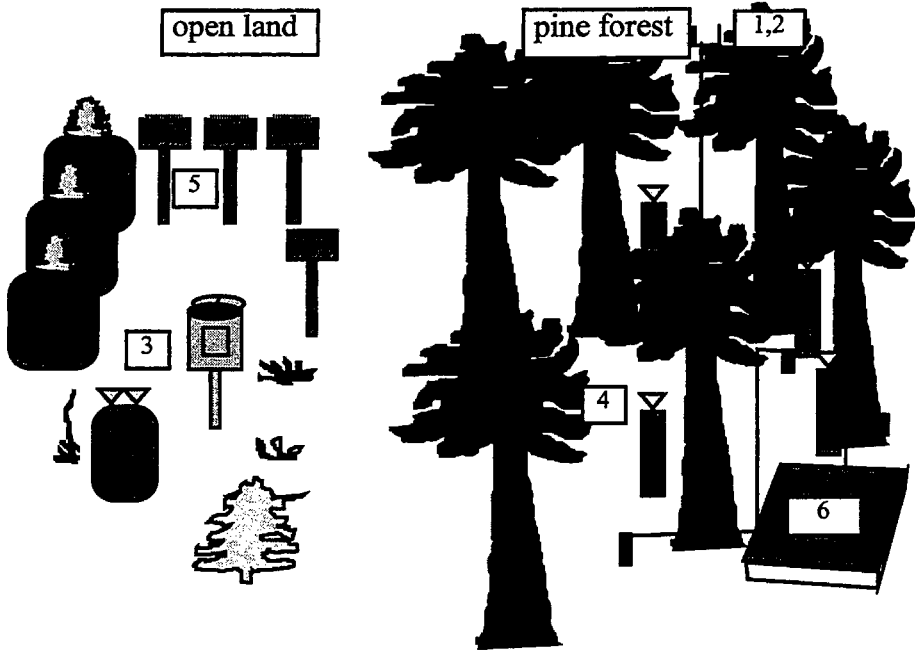

*Figure 1*  
*Schematic view of the measuring station*

- 1,2 : NH<sub>x</sub> and meteorological measurements
- 3 : sampler for wet-only and bulk deposition
- 4 : sampler for rain throughfall
- 5 : biomonitoring with grass, norway spruce and lichens
- 6 : measurements of soil water contents and fluxes

### 3. Results

#### 3.1. Ammonia/ammonium (NH<sub>x</sub>) N contents in the air

The average ammonia N contents in the air (figure 2) were in close correlation to the livestock densities of the regions. In the region with a livestock density > 3 LU ha<sup>-1</sup>, the average NH<sub>x</sub> concentration in the air was 7.1 µg m<sup>-3</sup> NH<sub>x</sub>. Apparently lower was the concentration in the region with a livestock density between 1.5 and 2.5 LU ha<sup>-1</sup> (4.4 µg m<sup>-3</sup> NH<sub>x</sub>) and lowest in the region with a livestock density below 1.5 LU ha<sup>-1</sup> (2.4 µg m<sup>-3</sup> NH<sub>x</sub>).

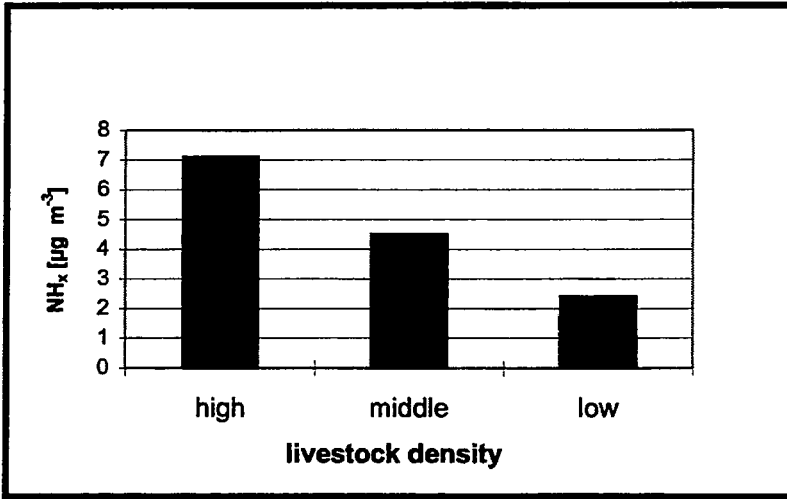

*Figure 2*

*Average  $\text{NH}_x$  concentration in the air, measured above the forest canopy between October 1996 and November 1997*

Figure 3 shows the 2-week-averages of the  $\text{NH}_x$  concentrations in the years 1996 and 1997. In both years and especially in the regions with a higher livestock density, there is a clear maximum in the  $\text{NH}_x$  concentrations in the beginning of the year (10<sup>th</sup> until 20<sup>th</sup> week), that means during the main period of slurry application. In the following weeks the concentrations decreased, but increased again in the late summer months, also caused by slurry application. The lowest concentrations could be determined in the winter months, that means in the time without manuring activities.

These results show again very clearly that slurry application is the main source of ammonia emissions (and that the main task must be to decrease these emissions by proper application).



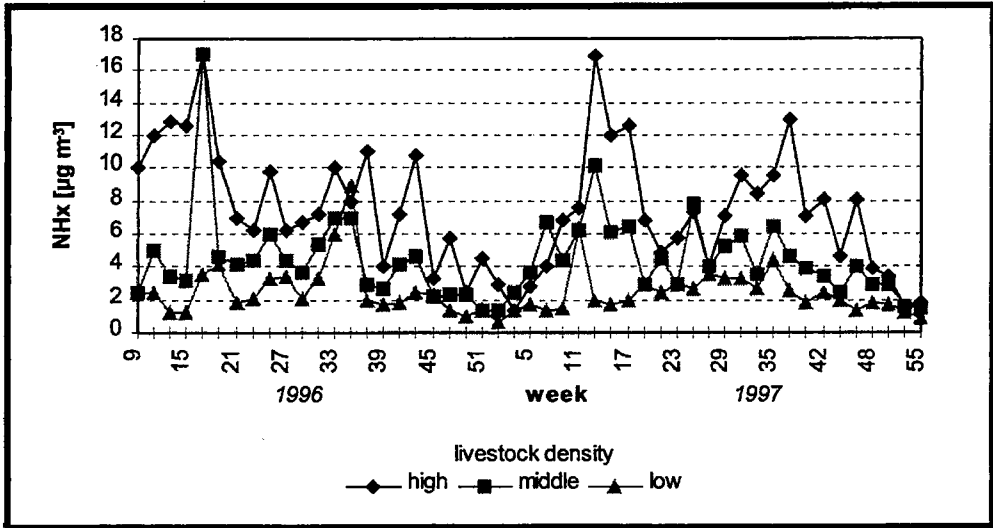

**Figure 3**  
*NH<sub>x</sub> concentrations in the air, measured above the forest canopy, two week averages.*

### 3.2. Nitrogen deposition

Figure 4 shows the wet nitrogen deposition rates in the forest 1996 and 1997. The results can be summarized as follows :

- In the first two years of our measurements, we found nitrogen deposition rates to differ a lot in all three regions. In 1996, the deposition rates were 20 - 50% lower than in the year 1997.
- These different deposition rates do not correspond with the ammonia N concentrations in the air, which were in average at the same level in both years.
- An explanation for the different N deposition rates can be given considering the weather conditions. 1996 was characterized by low precipitation rates in the months from February until April, the period with the highest ammonia N contents in the air, i.e. the input into soils and plants was very low. In 1997, average precipitation rates occurred in late winter and spring. This resulted in higher deposition rates.
- In 1997, the N deposition rates in the region with a livestock density of 1.5 - 2.5 LU ha<sup>-1</sup> were higher than in the region with a livestock density > 3.5 LU ha<sup>-1</sup>, although the ammonia N contents measured in the air were r.a. 35% higher in the region with the highest livestock density. Also in the previous year, the differences in the N deposition rates between these two regions were relatively small. These results show that additional factors may determine the deposition rates, e.g. co-

deposition of ammonia with sulphate and chloride in the precipitation ( $\text{SO}_2$  concentrations in the air). Further measurements should provide an answer to this problem.

> In total, the N deposition rates were lower as we expected compared to other results in the literature. This counts especially for the region with a high livestock density. One reason could be that the N deposition was measured in the middle of the forests. First measurements show that the N deposition rates can be 30 - 80% higher at the edge of forests.

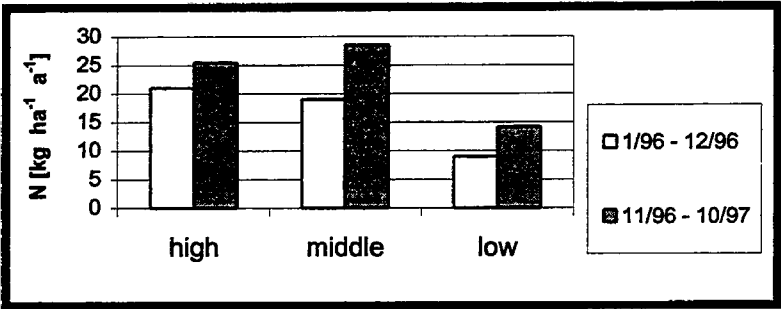

Figure 4

*N deposition (throughfall) in pine forests in regions with different livestock density*

On open land, the N deposition rates were much lower than in forests (figure 5). Dependig on livestock density and on weather conditions, measured deposition rates between 10 and 15 kg ha<sup>-1</sup> a<sup>-1</sup> were measured.

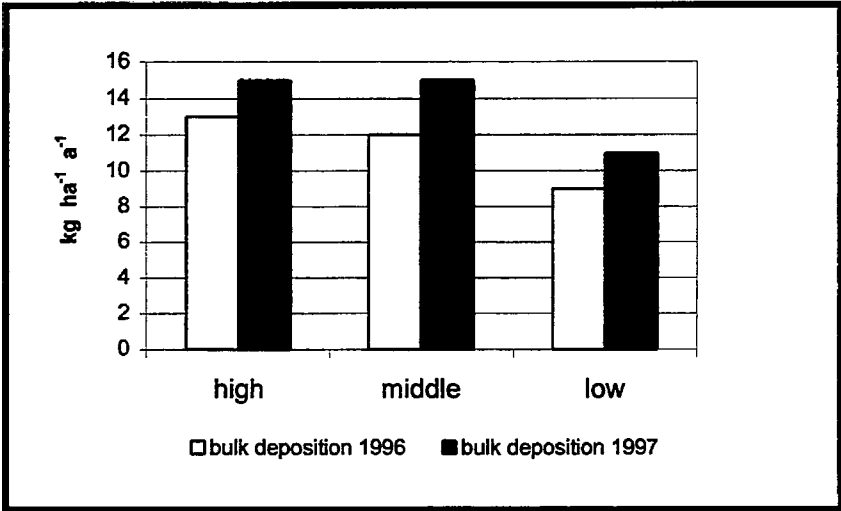

Figure 5

*N deposition (bulk) in open land regions with different livestock density*

### 3.3. N contents in soil water

In the forest soils, water samples were taken from 70 cm depth in the late autumn and winter months. The average N contents in the soil water at the three sites are shown in figure 6. Compared to N contents in the soil water of arable soils, the N contents under these forest soils were relatively low. But they also showed a close relation to the livestock density of the three regions.

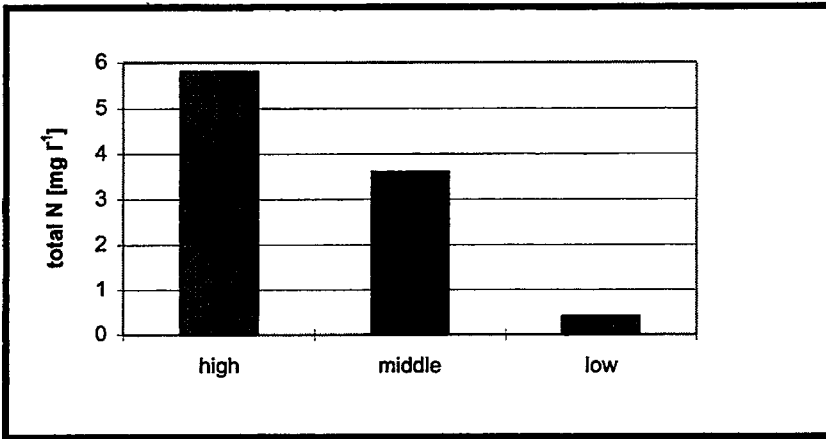

Figure 6

*N contents in soil water from pine stands in regions with different livestock density*

## 4. Conclusion

4.1. With increasing livestock density the  $\text{NH}_x$  contents in the air increased. The highest concentrations could be found in the months of February until April and August until October, that means during the period of slurry spreading.

4.2. Also the nitrogen deposition rates increased with increasing livestock density. In the open land, between 10 and 15  $\text{kg ha}^{-1} \text{a}^{-1}$  N were deposited, inside of pine forests between 9 and 28  $\text{kg ha}^{-1} \text{a}^{-1}$  N and at the edge of these forests between 30 and 80% more.

4.3. The nitrogen deposition rates were strongly influenced by weather conditions. In the first year with dry weather conditions in February until April - that means in the time with the highest  $\text{NH}_x$  concentrations in the air - the deposition rates were found to be between 25 and 50% lower than in the second year with wet weather conditions from February until April.

4.4. In the region with a low livestock density, the nitrate N content in soil water under forests was below 1  $\text{mg l}^{-1}$  N, in the region with the high livestock density between 5 and 6  $\text{mg l}^{-1}$  N.



# Odour and ammonia emission control by slurry treatment and covering

*Maîtrise des émissions d'ammoniac et d'odeurs par traitement et couverture du lisier.*

**G. Hörnig, W. Berg and U. Wanka**

Institute of Agricultural Engineering Bornim (ATB), Division Engineering for Livestock Management, D-14469 Potsdam, Germany, and Saxon County Institution for Agriculture, D-04886 Köllitsch, Germany  
E-mail : ghoernig@atb.uni-potsdam.de

## Abstract

*We tested in a practical scale Bentonite as feed additive and lactic acid to reduce the pH-values of liquid manure. An algal material and lactic acid for slurry treatment are investigated in lab-scale, just as stone granules, chopped straw and rape oil as covering of storage tanks. Bentonite reduces both the odour and the ammonia flow rate by 33 % and 25 %, respectively. The algal substance reduces the odour emission but not the ammonia volatilization. Acidification with lactic acid has a lasting effect on ammonia, methane and nitrous oxide emission but not on odour emission. Granules and chopped straw as covering materials reduce both the odour and the ammonia release by about 80 %.*

Keywords : Odour, ammonia, emission, slurry treatment, covering

## Résumé

Nous avons testé, à l'échelle de la ferme, la Bentonite en tant qu'additif alimentaire et l'acide lactique pour réduire le pH des lisiers. Un produit à base d'algues et d'acide lactique pour le traitement du lisier a été étudié à l'échelle du laboratoire, ainsi que des granules, de la paille chopée et des tiges de colza pour la couverture des fosses. La Bentonite permet une réduction des odeurs et de l'ammoniac de l'ordre de 33% et 25% respectivement. Le produit à base d'algues réduit les émissions d'odeurs mais pas la volatilisation de l'ammoniac. L'acidification à l'aide d'acide lactique a un effet retard sur les émissions d'ammoniac, du méthane et de protoxyde d'azote mais pas d'effet sur les odeurs. Les granules et les substrats chopés utilisés pour la couverture réduisent à la fois les odeurs et les émissions d'ammoniac de 80%.

Mots-clés : odeurs, ammoniac, émission, traitement lisier, couverture.

# 1. Introduction

Farms with animal husbandry have to protect the neighbours against nuisance caused by odours, and the nature against harmful gas emissions e. g. ammonia, methane and nitrous oxide.

The required distance between odour emitting animal production facilities and residential areas is regulated by the so-called "Distance regulation" enclosed in the VDI-guideline "Emission control - Livestock farming". If this distance is not sufficient additional measures are necessary to reduce emissions. For the limitation of noxious gas emission there are no instructions. Only the decrees for the keeping of pigs and calves contain a limit of 20 ppm for ammonia.

Emission reduction from the stables is attainable by measures of feeding, animal keeping and ventilation, not least by a good management regarding dry and clean surfaces. The emissions from the storage containers may be reduced by the constructive design, low temperatures (e.g. shady location) and coverings.

Our research work aims to control the emissions by material and process engineering measures. In this paper it will be reported on the interaction between harmful gases and odour under use of feed and slurry additives as well as of alternative coverings for storage tanks.

# 2. Materials and methods

The already tested materials and those now being tested are shown in Table 1.

Material group	Material	Feed additive (F) Slurry additive (S) Covering (C)	Scale
Clay minerals	Bentonite	F	on-farm
Plant extracts	Algae	S	lab-scale
Organic acids	Lactic acid	S	lab-scale, on-farm
Swimming layers	Chopped straw	C	on-farm, lab-scale
	Stone granules	C	on-farm, lab-scale
	Rape oil	C	lab-scale

*Table 1  
Tested feed and slurry additives as well as swimming covers*

Two groups of growing pigs (390 pigs in control group, 367 in trial group) were kept under almost identical conditions in a forced ventilated stable. The pigs of the trial group received 2 % **Bentonite** with feed during 10 weeks.

Treatment of pig slurry with a **algal material** was investigated in Perspex containers on a 50 litres scale. The DM content of slurry was to 8.0 %, the addition range 0.02 %. The investigation covered a period of eight weeks.

Acidification of pig and cattle slurry with **lactic acid** was carried out in a 75 litres

scale. Adjusted pH values came to 3.8, 4.3 and 4.8. The dry matter content was between 5.5 % and 10.4 %. The slurries were stored over a period of 183 and 190 days, respectively.

**Chopped straw** and **floatable stone granules** were investigated in comparable pig breeding farms in 16 m-diameter storage containers. Chopped straw in a quantity of 4 kg/m<sup>2</sup> was spread with a blower and then mixed with the slurry. The used granules called "PEGÜLIT R" and "PEGÜLIT M" consist of a white floatable natural stone with different processing. The layers with an intensity of 10 cm were spread with a blower and mixed with the slurry.

Pig slurry covered with **rape oil** was investigated in a 65 litres scale too. The investigations were carried out in transparent Perspex containers to observe and register the swimming behaviour of the coverings.

According to the test objectives the measured parameters were :

- ammonia, methane and nitrous oxide concentration (photoacoustic gas monitor),
- odour concentration (olfactometer),
- sedimentation, and flow properties (rotational-type viscometer).

### 3. Results

#### Bentonite

Bentonite with its main component montmorillonite as a feed additive affects the excrements by cation exchange and adsorption. So ammonia is bound in gastrointestinal tract. As a result the ammonia emission is influenced. Ammonia concentrations in the air in the trial compartment ranged between 5.9 and 10.7 mg/m<sup>3</sup> and in the control compartment between 4.9 and 13.9 mg/m<sup>3</sup>. This is the normal range for fattening pigs. NH<sub>3</sub>-flowrates, calculated from concentration and ventilation rate, were lower by 10 to 33 % for the experimental group than for the control group (Figure 1). The effect of emission reduction turned out even better as regards odour. An emission reduction by 26 to 37 % was observed (trial: 19 to 43 odour units/s × livestock unit, control: 32 to 59 odour units/s × livestock unit).

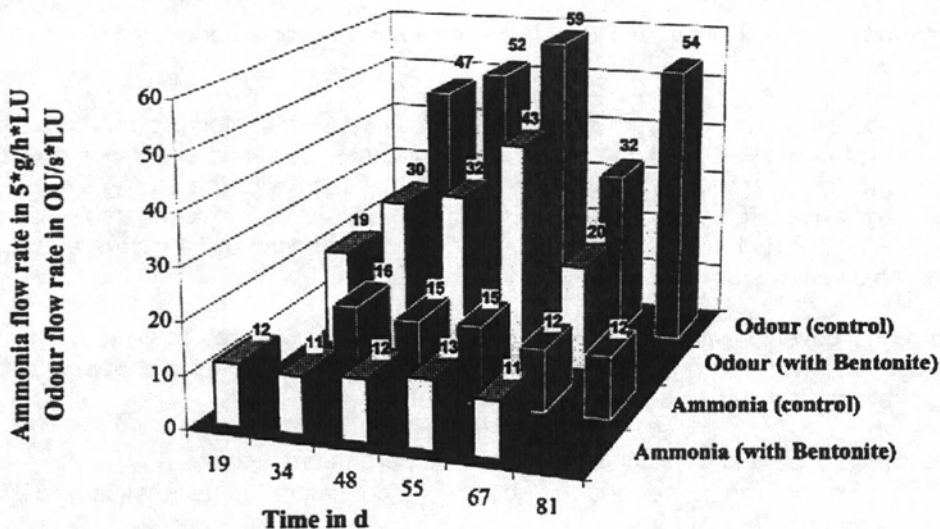

Figure 1

Ammonia and odour flow rate under use of BENTONITE as feed additive (investigations in a stable with growing pigs)

The ratio of ammonium to total nitrogen content in slurry of pigs fed with Bentonite was 15 to 20 % higher despite higher pH values (control: 0.34 to 0.44, trial: 0.45 to 0.53).

#### Algal material

The use of algae aims to increase of bacterial activities in the slurry. Our test results show different effects on ammonia and odour emission (Figure 2). Whereas at the beginning of the test period odour concentration of the trial samples was higher than of the control samples, the trend was turning back after one week. Then the odour emission reduction for the trial samples ranged between 35 and 55 % compared with the untreated slurry. In contrast to this no differences were ascertainable regarding the ammonia emissions.



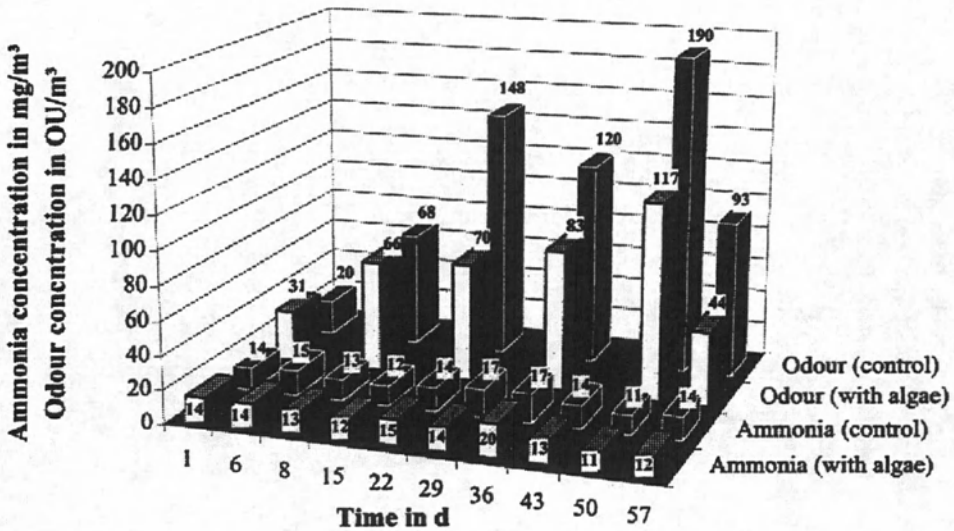

Figure 2

Ammonia and odour concentration under use of an algal material as slurry additive (pig slurry, DM = 8.0 %)

### Lactic acid

As reported in former times pH values under 4.5 must be reached to reduce the noxious gas emissions noticeably. The supply of acid depends on the kind and dry matter content of slurry. Acidifying of cattle slurry at pH = 4.5 requires a lactic acid addition of about 4 % by volume. The addition rate must be little higher for pig slurry. During storage lower pH values were more steady than higher ones. To keep the pH at the desired value of 4.5 lactic acid had to be added four times. To the sample with the desired pH value of 4.0 lactic acid had to be added only one time (shortly before the end of storage time). The weekly measurements of gaseous emissions confirmed the influence of temperature, pH value and the condition of the slurry surface. So the ammonia concentration of control sample was strongly decreased by encrustation of its surface. Simultaneous with encrustation nitrous oxide emissions were detected. But even compared with encrusted control sample the reduction of pH value by acidifying with lactic acid caused a decrease of ammonia emission (Figure 3) and also of methane emission (Figure 4). Nitrous oxide emission was measured at non-acidified encrusted samples only.

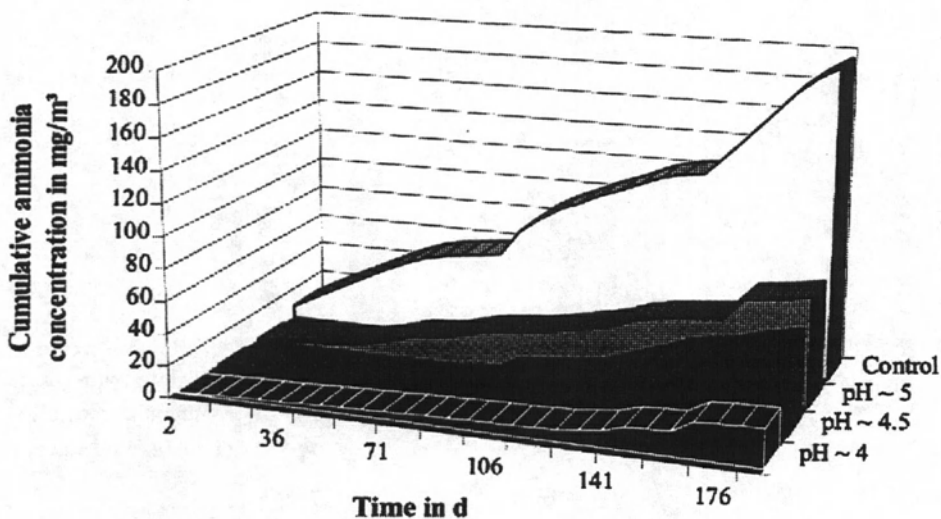

Figure 3

Cumulative ammonia concentration above cattle slurry acidified with lactic acid (DM = 7.8 %)

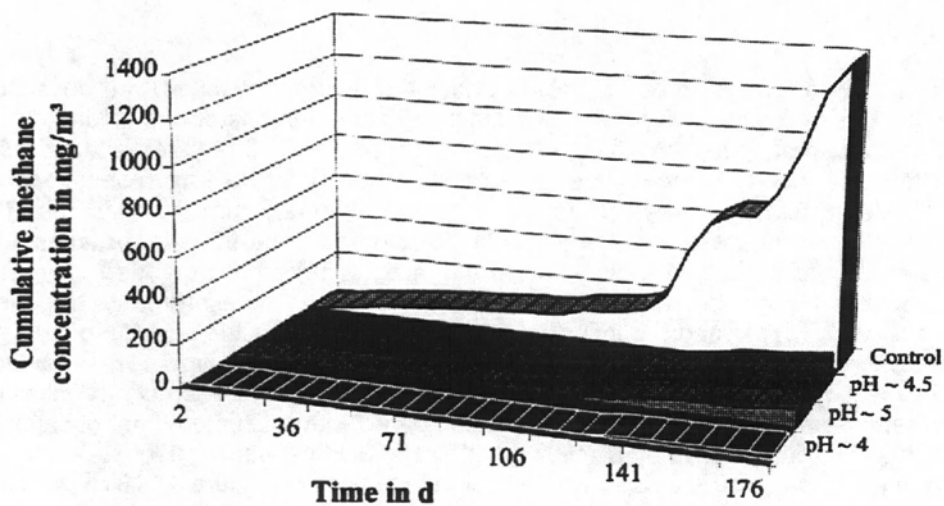

Figure 4

Cumulative methane concentration above cattle slurry acidified with lactic acid (DM = 7.8 %)

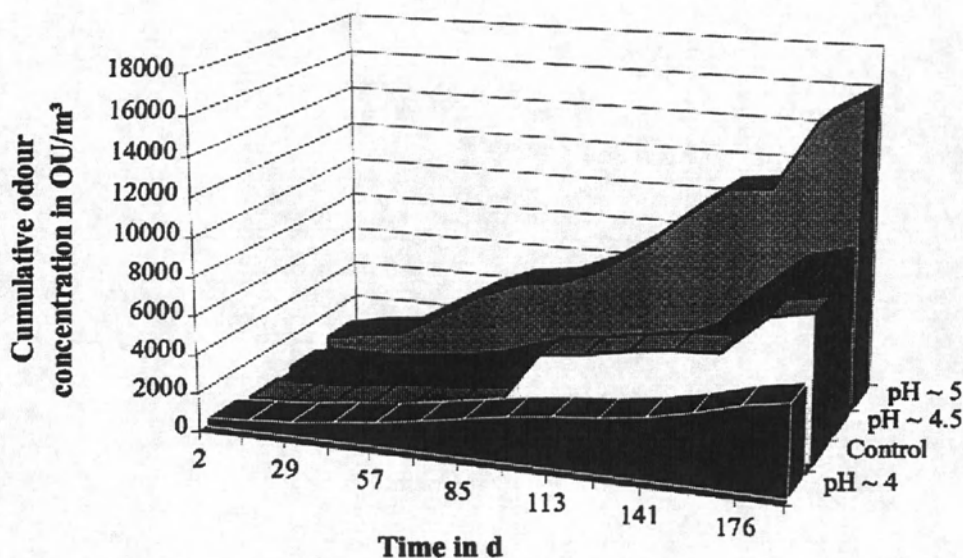

Figure 5  
Cumulative odour concentration above cattle slurry acidified with lactic acid  
(DM = 7.8 %)

The cumulative odour concentration for the slurry with pH  $\cong$  4 was lower than for the control, but it was a little higher for pH  $\cong$  4.5 and considerably higher for pH  $\cong$  5. A different kind of odour was ascertainable: approximately like grass silage.

It is concluded that the acidification of slurry with lactic acid offers advantages concerning the reduction of environmentally relevant gases. The odour emission is rather higher compared with untreated slurry.

#### Chopped straw and stone granules

The straw layer varied depending on measuring point between 5 and 15 cm. A thicker straw layer caused a higher ammonia reduction rate. The ammonia and odour emissions were reduced by about 80 % (Figure 6), the methane and nitrous oxide volatilization by 45 % and 13 %, respectively.

There were considerable differences between the two 10 cm thick granules layers (Figure 6). Pegülit M held back more  $\text{NH}_3$  and odour than Pegülit R. The cause for that were clefts in the Pegülit R-cover caused by motion of the surface during slurry refilling. Altogether high emission reduction rates are available with coverings consisting of floating stone granules. Similar results are reported by other authors.

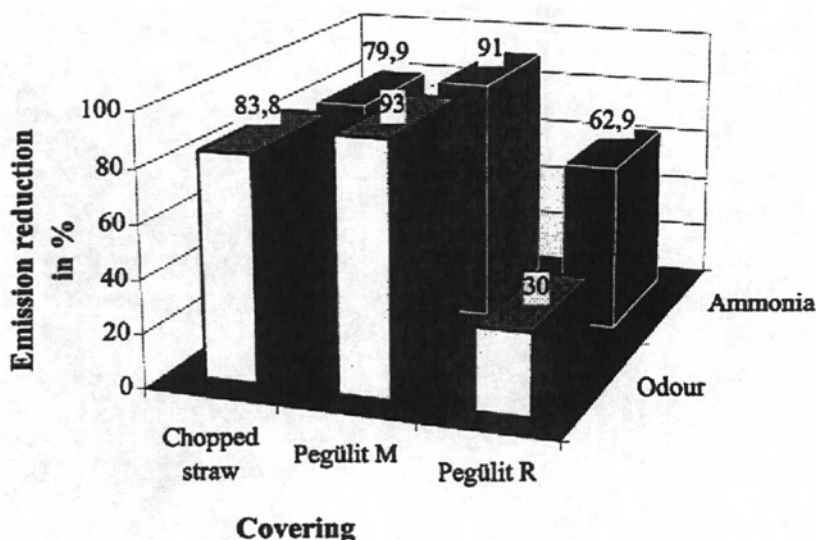

Figure 6

Emission reduction rates of different swimming covers (pig slurry, on-farm study)

### Rape oil

The rape oil was applied with a thick of 3 mm and of 6 mm. The slurry in one of two containers covered with a 6 mm rape oil layer was homogenized three times.

A 6 mm rape oil layer reduced the ammonia flow rate from the slurry surface by about 85 %. There were no differences between homogenized and not homogenized slurry. The reduction rate of a 3 mm rape oil layer amounted to at least over 50 %.

An important aspect concerns the floating behaviour of such coverings after mechanical strain. Straw mixed with slurry made a compact floating layer infiltrated with gas bubbles. After homogenization the covering material went up to the surface completely in the course of a few hours. Pegülit went up to the surface very quickly, even though slurry particles were included in the covering layer.

Rape oil as a 3 mm or 6 mm layer rose to the surface during a period of several days also after repeated homogenizations. It formed a closed layer again, but was infiltrated with manure particles. The sealing against emitting gases was very effective. But the mixture from oil and slurry caused odour (Figure 8). So the cumulative odour concentration for the test period of 12 weeks was two times higher than for the control sample. This is an evident disadvantage of rape oil covering.

## **4. Conclusion**

**4.1.** Measures of slurry treatment and covering do not have an equal effect on noxious gas and odour emission. Lactic acid as material for the slurry treatment take up the first place in reducing ammonia, methane and nitrous oxide emission, but the odour emission was rather higher compared with untreated slurry. On the other hand algal substances reduced the odour emission but not the ammonia volatilization.

**4.2.** Bentonite as feed additive reduced both the odour and ammonia flow rate. The same also applies to the tested granules and chopped straw. Because rape oil was mixing with slurry particles during the storage time the air pollution by odour was higher than by uncovered slurry. While a rape oil layer caused a decrease of  $\text{NH}_3$  emission by about 85 %.

**4.3.** Very complex chemical and physical as well as temporally changing processes are the causes for such an irregular behaviour. This means that material and process engineering measures must be used selectively for improving of environmental situation in livestock husbandry.



# Human urine and effluents from digestion of food refuse as a fertiliser to barley - crop yields, ammonia emission and nitrate leakage

*Utilisation de l'urine humaine et d'effluents issus de la digestion de déchets alimentaires en tant que fertilisant pour l'orge, émissions d'ammoniac et pertes nitriques.*

**Elmsquist H\*, Rodhe L., Blomberg M., Steineck S\***

Dept. of Soil Sciences, Swedish.  
University of Agricultural Sciences,  
Box 7014. S-750 07 Uppsala. Sweden.  
Tel : +46 18 67 18 55.  
Fax : + 46 18 67 18 88.  
E-mail : helena.elmquist@mv.slu.se

**Lindén B.**

Swedish University of Agricultural  
Sciences, Box 234. S-532 23 Skara.  
Sweden.

\* Swedish Institute of Agricultural  
Engineering. Box 7033.  
S-750 07 Uppsala. Sweden

## Abstract

*A field trial investigating the fertilising effect of stored human urine, effluents from digested food refuse and mineral fertilisers applied to barley was performed in 1997 on a farm south of Stockholm. Nitrogen efficiency and influence on yield and grain quality was studied. Ammonia emissions were measured after application of human urine. The risk of nitrate leakage was just as high from organic as from mineral fertiliser used. A nutrient balance of nitrogen added and nitrogen removed from the fields by the crops verifies that large inputs increases residual nitrogen. These are results from just one year of field trials and more experiments are needed to study plant nutrient efficiency and to measure nitrogen losses. The study will continue in 1998.*

*Keywords : human urine, ammonia emission, barley yield, nitrogen utilisation, nitrogen balance, nitrate leakage.*

## Résumé

Un essai au champ a été réalisé pour déterminer l'effet fertilisant, de l'urine humaine stockée, d'effluents issus de la digestion de déchets alimentaires et d'engrais minéraux, épandus sur orge, en 1997 dans une exploitation située au sud de Stockholm. L'efficacité azotée et l'influence sur le rendement en grains et sur la qualité, ont été étudiés. Les émissions d'ammoniac ont été mesurées après épandage de l'urine. Le risque de pertes sous forme d'azote nitrique est aussi important à partir des apports organiques que des engrais minéraux. Un bilan azote entre les entrées et les sorties confirme que les apports massifs augmentent la teneur en azote résiduel. Ce sont des résultats préliminaires tirés de la première année d'expérimentation, qui nécessitent d'être vérifiés par d'autres essais. Nous étudierons notamment l'utilisation d'azote par la plante et les pertes azotées.

Mots-clés : urine humaine, émissions d'ammoniac, rendement orge, utilisation azote, bilan azoté, fuits nitriques.

## 1. Introduction

The Swedish society strives towards sustainable living with integrated solutions between consumers and producers of food. Clean refuses from restaurants and households are possible sources for energy and plant nutrients. The new challenge is to find hygienic and "environmentally sound" solutions for recycling plant nutrients in food back to agricultural land where air and water quality is improved at the same time as nutrient resources are recycled back to the farmers as organic manure.

Swedish agriculture annually produces living animals, milk, eggs, vegetables and grain containing 65 000 tonnes of nitrogen and 11 000 tonnes of phosphorus out of which 20 per cent is lost in the food processing industry (Claesson & Steineck 1996). The food is consumed and energy is used by man, but most plant nutrients pass the human body right into the toilet. The plant nutrients are collected in waste water treatment plants and a large part enters the environment depending on the system used.

Today, many private households lack a purification system or have a deficient system. Aaltonen & Andersson (1995) showed that sand filter beds in Sweden have deficient purification efficiency. After 13 years the sand filter has become a source instead of a sink for nutrients.

Separating urine from faeces directly in the toilet is one of many solutions of making recycling of nutrients possible without unwanted pollutants. The nitrogen content in human urine in Sweden is equivalent to one fifth of nitrogen in mineral fertilisers sold in 1995. There is an interest from ecological farmers in Sweden to use human urine as liquid manure because of the content of easily soluble nitrogen, phosphorus and the low heavy metal content (Lindén, 1997). Effluents from digestion of food refuse is another example of a new organic fertiliser rich in plant nutrients. During the digestion energy is captured in methane gas. Leftovers are suitable for using as fertiliser since all plant nutrients are retained in the residual effluents.

There is a need for research on efficiency and environmental impact from new organic fertilisers. Humans excrete a larger proportion of their nitrogen and phosphorus intake in the urine than pigs. Most of the nitrogen, N, in human urine is in plant available form as ammonia nitrogen (Kirchmann & Pettersson, 1995; Claesson & Steineck, 1996). The nitrogen content in stored human urine depends on the toilet flushing capacity by dilution.

Stored human urine normally has a higher pH - 8.6-9.2 - than animal urine with a pH value of 8.4-8.8. A high pH increases the risk for ammonia losses during storage and after spreading. Ammonia emissions are both a resource problem and an environmental problem (Löfgren et al. 1998). The high pH in human urine may have a positive effect in killing infectious bacteria and virus (Höglund et. al., 1997). Effluents from digestion has a high pH 8-9 as well.



The material for digestion is pasteurised one hour in 70° C before treatment in a digestion chamber. The content of nutrients in effluents from digestion depends on the material and the process. In most cases the nutrients are the same as in animal slurry.

The objective of the study was to determine the effect of application rate on grain yield, nitrogen utilisation and ammonia emissions after spreading human urine and effluents from digestion of food refuse compared to mineral fertiliser and to estimate the risk of nitrate leakage based on nitrogen in the soil in late autumn.

## **2. Materials and methods**

Fertiliser value of human urine and effluents from digestion of food refuse was studied in a field trial with barley 1997. The experimental design was randomised blocks with three replicates. Organic manure and mineral fertiliser were applied on 21 May, and on the following day barley was sown. Human urine and effluents from digestion of food refuse were applied with a plot spreader with trailing hoses (0.25 m apart). Incorporation into the soil with a light harrow was done four hours after spreading. Eleven treatments were included in the trial. Human urine was banded to barley before sowing at four different rates, 8, 21, 28 and 59 tonnes per hectare. A control treatment with no fertiliser and treatments with mineral fertiliser, NPK, were included at the rate of 0, 30, 60, 90 and 120 kg nitrogen per hectare. Applications of effluents from digestion of food refuse were done at 22 tonnes per hectare in the spring and 28 tonnes per hectare in the summer when the barley was 10 cm.

Ammonia emissions from plots treated with urine were measured at the application rates of 8, 21 and 59 tonnes of human urine per hectare. A micrometeorological method of measuring gaseous ammonia (NH<sub>3</sub>) was used based on passive diffusion sampling close to the ground (Svensson, 1994). On each plot, measurements of ammonia emissions were carried out with two chambers to estimate the equilibrium concentration and with one ambient measuring unit to estimate the concentration of NH<sub>3</sub> in the ambient air. The NH<sub>3</sub> emissions were measured during three periods directly after spreading. The periods were 0-1 h, 1-4 h and 4-22 h after spreading. The measurements were followed by harrowing after 4 hours. Climatic conditions were registered in the field during the measurements of ammonia. Air temperature was 7.3 °C in average. Soil surface temperature was 8.8 °C and wind velocity 3.6 meters per second.

The barley was harvested at maturation, (11 September) and the weight was registered. The grain was analysed for volume weight, content of dry matter and total nitrogen. Sampling and analysis of the soil was made in the spring before sowing (4 May), before maturation (15 August) and late in the autumn (28 October) to decide nitrogen mineralisation and estimate the risk of N leakage.

The stored human urine originated from people living in ecological villages in Stockholm. They have installed urine separating toilets separating urine from faeces in the toilet (Jönsson et. al., 1997). The effluents from digestion of food refuse came from a project "From dining table to soil", recycling food refuse in Stockholm. Samples of urine and effluents from digestion were taken at spreading for analyses of dry matter (DM), pH, ammonia-nitrogen, total nitrogen, phosphorus, potassium and ashes. See table 1.

The field trial was located south of Stockholm. The soil in the field is a clay loam with 2.8 % soil organic matter (SOM) and with a pH 6.6.

	Dry matter content %	Ashes % of dry matter	pH	Nutrient content, kg/tonnes			
				NH <sub>4</sub> -N	Tot-N	P	K
Human urine	0,74	83	8,9	3,4	3,7	0,3	1,0
Effluents from digestion, spring application	1,8	39	8,6	2,2	3,6	0,19	0,99
Effluents from digestion, summer application	2,3	43	8,0	2,3	3,5	0,20	0,8

*Table 1.*

*Content of dry matter, ashes, in percent, and ammonia-nitrogen, total nitrogen, phosphorus, potassium in kg per tonnes and pH-level in human urine and effluents from digestion of food refuse.*

Grain yield data were analysed by a polynomial regression model with polynomial curves with a common intercept. Significant tests were conducted for differences in the shapes of the curves.

### **3. Results and discussion**

The yield response curves with the amount of nitrogen as dependent variable were significantly different both in the x-term ( $p < 0.001$ ) and in the  $x^2$ -term ( $p < 0.004$ ) for human urine compared to mineral fertiliser.

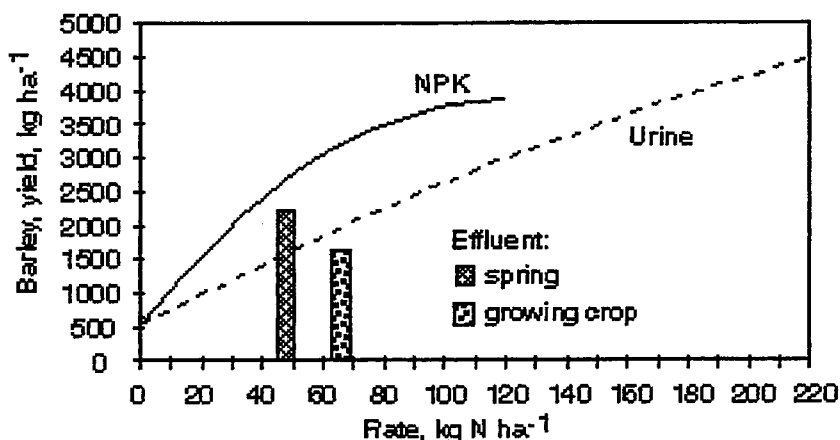

Figure 1.

Yield of barley with 15% water content after application of human urine, mineral fertiliser and effluents from digestion of food refuse. The regression polynomial is for human urine  $y = 588 + 22.6 * x - 0.022 * x^2$  and NPK  $y = 588 + 54.6 * x - 0.226 * x^2$ . The bars show yield response for effluents applied at two different times.

An application of human urine containing 100 kg per hectare of total nitrogen yielded 2 600 kg barley per hectare. It was 32 percent less barley than the same amount of nitrogen in mineral fertilisers yielded. A spring application of effluents from digestion of food refuse containing 48 kg nitrogen per hectare yielded 2 210 kg barley. Compared to the same amount of nitrogen in mineral fertilisers the yield was 18 percent lower. In the beginning of July when the crop was 10 cm, an application of effluents from digestion of food refuse with 66 kg nitrogen per hectare yielded 1 660 kg barley per hectare. It was 48 percent lower yield than for the same amount of nitrogen in mineral fertilisers applied at sowing.

An application of 100 kg of nitrogen in mineral fertilisers yielded 3 780 kg grain per hectare. It is lower than normal due to the weather and also the to the fact that the field was sown two weeks after normal sowing time. Excessive rain in April and May resulted in a slow drying up process of the soil. June was wet and July was extremely dry and warm. (Elmqvist et al, 1998). The normal reference yield of barley for this area is 4 510 kg per hectare (SCB, 1997a). Barley yields in the trial were lower than normally thanks to the late sowing time but differences in nitrogen response in the yields were still quite evident. The field trial in 1997 was the first year of trials and results from just one year can not be used for advice. Weather conditions are dominating yields of all crops and more trials are necessary.

In the field trial as well as in pot experiments using the same human urine no toxic effects were visible in the crops (Kvarnmo, 1998).

In figure 2 the accumulated nitrogen losses of ammonia after application of human urine are shown. The highest ammonia losses occurred after the highest rate

applied, 59 tonnes of human urine per hectare, and was 8.9 percent of N applied. Corresponding ammonia losses for 8 tonnes per hectare was 6.3 percent and for 21 tonnes per hectare 5.5 percent of N applied in human urine.

For the two lower application rates, the losses were small after incorporation of the urine in the soil four hours after spreading (Malgeryd, 1996). At the highest rate, ammonia emissions continued to occur in spite of incorporation into the soil, but at a lower rate.

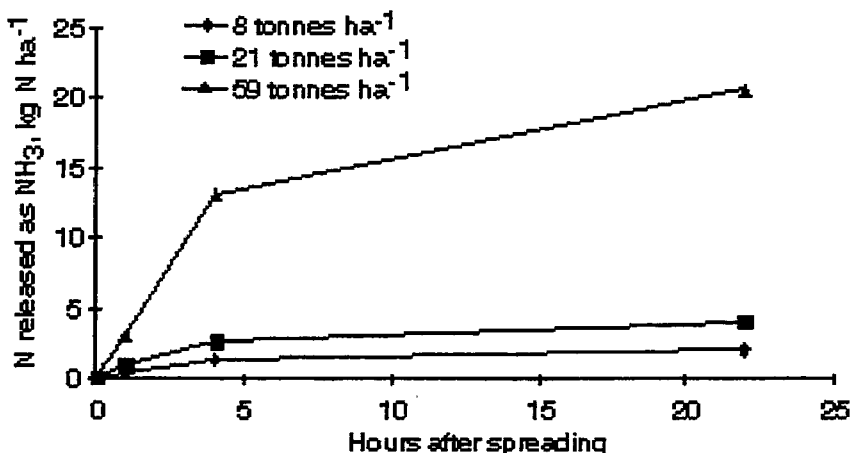

Figure 2.

*Accumulative nitrogen losses as ammonia after spreading of human urine. Four hours after spreading the urine was incorporated into the soil by a light harrow and after 22 hours the measurements were finished, since it was time to sow the barley.*

A comparison of ammonia emission from swine urine (Rodhe & Johansson, 1996) and human urine (Johansson, 1997) both applied in the spring before sowing, shows that losses were about the same and less than 10 percent of total nitrogen applied. Another study where cattle urine was applied to ley resulted in much higher losses, 20-86 percent of total nitrogen, depending on application time and technique (Rodhe et al, 1997).

A nitrogen balance is a useful tool to evaluate the efficiency of nitrogen when using different kinds of fertilisers and amounts of nitrogen (SCB, 1997b). The net mineralisation of soil nitrogen during the season is calculated from the control to 35 kg nitrogen per hectare, see table 2. It is calculated from nitrogen in the grain, root and straw of the barley just before harvest, plus mineral nitrogen in the soil at spring, minus mineral nitrogen in the soil before harvest.

	Applica- tion rates of mineral nitrogen	Import of total nitrogen, (mineral and organic nitrogen)	Net minerali- sation of soil nitrogen	Import of nitrogen via depositio n (S.J.V, 1997)	Export of nitrogen in barley yield	Calculated rest of nitrogen (import minus export)	Measured rest of nitrogen in the soil 0-90 cm (autumn)
	kg/ha	kg/ha	kg/ha	kg/ha	kg/ha	kg/ha	kg/ha
Control		0	35	10	12	33	35
Human urine	26	28	35	10	13	60	34
Human urine	69	74	35	10	24	95	35
Human urine	98	105	35	10	40	110	35
Human urine	212	230	35	10	71	204	37
NPK	30	30	35	10	29	46	33
NPK	60	60	35	10	39	66	34
NPK	90	90	35	10	55	80	31
NPK	120	120	35	10	61	104	33
Effluents spring appl.	48	79	35	10	30	94	37
Effluents summer appl.	66	101	35	10	26	120	45

*Table 2.*

*Nitrogen balance indicating import and output of nitrogen in the field trial in 1997  
(total nitrogen in kg per hectare)*

The nutrient balance of added nitrogen and nitrogen removed from the field by the crop verifies that large inputs increases residual nitrogen. It is not found in the soil as mineral nitrogen in the autumn.

According to measurements of the content of mineral nitrogen in the soil (0-90 cm) before freezing in the autumn (table 2) the risk of nitrate leaching after application of stored human urine and effluents from digestion is just as high as from mineral fertilisers.

Results from just one year of field trials are insufficient and more experiments are needed to study plant nutrient efficiency and to examine nitrogen losses. This study will continue in 1998.

In developing future systems for recycling of nutrients from the society changes have to be based on local conditions and seen in a long perspective of time.

#### **4. Conclusions**

1. Stored human urine and effluents from digestion of food refuse can be used as fertiliser in grain cultivation.
2. An application of human urine containing 100 kg per hectare of total nitrogen yielded 2 600 kg grain of barley per hectare. It was 68% of what the same amount of nitrogen in mineral fertiliser yielded.
3. Application of effluents from digestion of food refuse at sowing time in spring yielded a higher harvest than application later in the summer.

4. An application of 48 kg nitrogen in effluents from digestion of food refuse, applied in spring, yielded 82% of the yield at the same rate of nitrogen in mineral fertilisers. A summer application of 66 kg nitrogen yielded 52 % of the harvest yielded at the same rate of nitrogen in mineral fertilisers.
5. Nitrogen lost as ammonia was in the range of 5.5-8.9 percent of nitrogen applied in stored human urine. Highest ammonia losses occurred after applying 59 tonnes per hectare. Differences in percentage losses between 8 and 21 tonnes per hectare were small.
6. According to measurements of the content of mineral nitrogen in the soil before freezing in the autumn, the risk of nitrate leaching after application of stored human urine and effluents from digestion is just as high as from mineral fertilisers.
7. The nutrient balance of added nitrogen and nitrogen removed from the field by the crop verifies that large inputs increases residual nitrogen.

The study was financed by Stockholm Water AB and SLF, SKAFAB/SRV.

## 5. References

- Aaltonen J. & Andersson P.** 1995. Durability and maintenance of ecotechnological wastewater treatment plants. Paper presented at the International Symposium Ecotechnics 95. March 29-31, 1995. Östersund. Proceedings from the MidUniversity. Sweden.
- Claesson S. & Steineck S.** 1996. Plant Nutrient Management and the Environment. Special reports NR 41. Swedish University of Agricultural and Science, SLU. Uppsala.
- Elmquist H., Rodhe L. Steineck S., Lindén B. & Blomberg M.,** 1998. Human urine and effluents from digestion of food refuse as fertiliser to barley - crop yields, nitrogen utilisation, ammonia emissions and nitrate leakage, a field trial in 1997. Swedish Institute of Agricultural Engineering, JTI, Uppsala. (In Swedish). Ms
- Höglund C. Stenström T.A., Jönsson H. & Sundin A.,** 1997. Evaluation of faecal contamination and microbial die-off in urine separating sewage systems. Swedish Institute for Infectious Disease Control, Department of Agricultural Engineering, Swedish University of Agricultural Sciences, Uppsala.
- Johansson, S.** 1997. Urine from an ecological village tested in field trials. Incorporation in the soil increases the harvest. *Biologik 2*. 1997. (In Swedish)
- Jönsson H., Stenström T.-A. & Sundin A.** 1997. Source separated urine-Nutrient and heavy metal content, water saving and faecal contamination. *Wat. Sci. Tech.*, 35(9):145-152.

**Kirchmann H. & Pettersson S.** 1995. Human urine - chemical composition and fertiliser use efficiency. *Fertiliser Research* 40: 149-154.

**Kvarnmo P.**, 1998. Human urine as a nitrogen fertiliser to cereals. Thesis for Master of Science in Agriculture. Swedish University of Agricultural and Science. Uppsala. (In Swedish).

**Lindén B.**, 1997. Human urine as a nitrogen fertiliser applied during crop growth to winter wheat and oats in organic farming. Department of Agricultural Research Skara. Serie B Crops and Soils Report 1. Sweden. (In Swedish).

**Löfgren S., Steineck S. & Jakobsson C.** 1998. Model analysis of environmental impact from two hypothetical agricultural production systems in Sweden, Denmark and Lithuania in the years 2010 and 2030. *Baltic Sea Agenda* 21. JTI-report, nr 243, Institute of Agricultural Engineering, Uppsala. Sweden

**Malgeryd J.**, 1996. Measures to reduce ammonia emissions following application of animal manure. JTI -report nr 229, Institute of Agricultural Engineering, Uppsala. Sweden. (In Swedish).

**Rodhe L., Salomon E. & Johansson S.**, 1997. Spreading of Cattle Urine to Ley: Techniques, Ammonia Emissions and Crop Yields. In: *Gaseous Nitrogen Emissions from Grasslands*. Editors Jarvis S.C. & Pain B.F. pp. 109-114.

**Rödhe L. & Johansson S.**, 1996. Urine - application technique, ammonia emission and utilisation. JTI-report nr 217. Swedish Institute of Agricultural Engineering, Uppsala. (In Swedish)

**SJV**, 1997. Stank. SJV advisor programme for fertiliser use on farms in Sweden. Swedish Board of Agriculture, Jönköping.

**SCB**, 1997a. Standard yields for yield survey districts, counties and the whole of Sweden in 1997. J15 SM 9701. Statistics Sweden. Örebro.

**SCB**, 1997b. Nitrogen and phosphorus balances in arable land and the agricultural sector in Sweden 1995. Na 40 SM 9701. Statistics Sweden. Stockholm.

**Svensson L.**, 1994. A new dynamic chamber technique for measuring ammonia emissions from land-spread manure and fertilisers. *Acta Agriculturae Scandinavica Section B*, 44(1).





**Chairman's summary of part 3 bis**  
**Measurement, modelling and control of gaseous emissions**  
**Günter STEFFENS**

During this poster session papers, the authors mainly focused on ammonia, but also on methane, nitrous oxide and odour emissions. Measurements were taken from animal buildings, during storage and after land application. The organic residues investigated were slurry, farmyard manure, composts, sewage sludge, and human wastes. One paper dealt with ammonia deposition in forests.

The posters offered a comprehensive overview on the ongoing research work in the field of gaseous emissions from handling and utilisation of organic residues in agriculture. They presented a lot of new research activities, results and recommendations and showed from where emissions originate and how they can be reduced. It became clear that a lot of interactions occur between emissions of various gases and that it will be necessary in the future to look at the whole production cycle to keep emissions as low as possible. Some work is already going on in this direction and has been presented in some of the posters.



**Part 4 bis**

**Processing and handling of wastes.**

**Chairman : C.H. BURTON (U.K)**



## **Aeration of cattle slurry at low or high temperature in finish climate.**

*Aération du lisier bovin à basse ou haute température en climat finlandais.*

**Helvi Heinonen-Tanski**

Department of Environmental Sciences, University of Kuopio,

POB 1627, FIN 70211 Kuopio, Finland.

Email : heinotan@uku.fi

### **Abstract**

*The farms can produce up to 2 500 m<sup>3</sup> of slurry in Finnish climate with 7-9 months indoor feeding period the slurry must be spread as fertilizer in May or June onto grass if the cultivation of cereal is unprofitable. The hygienization in an individual farm has been done as farm size scale both at low temperature or at higher temperature. The aeration at low temperature has been done as batch process of 200-700 m<sup>3</sup> beginning often from 0°C and ending to 20-30°C. The aeration at high temperature has been done as continuously operating processes at 30-45°C in aeration units of approximately 10 m<sup>3</sup> with theoretical retention time of 5 days. The hygienization has been improved although missfunctions have been found to happen. The hygienization at high temperature may have also some inhibitory effect against clostridia.*

Keywords : butyric acid, clostridia, enteric microorganisms, grassland, hygiene, manure

### **Résumé**

Une exploitation peut produire jusqu'à 2500 m<sup>3</sup> de lisier. Dans les conditions climatiques finlandaises, avec des périodes de stabulation de 7 à 9 mois, ce lisier sera épandu en mai ou juin, sur prairie si les cultures de céréales ne sont pas rentables. L'hygiénisation dans une ferme individuelle a été effectuée, en conditions grandeur réelle, à la fois à basse température et à température plus élevée. L'aération à basse température a été testée en processus discontinu (batch) de 200-700 m<sup>3</sup> commençant à 0°C et pour finir à 20-30°C. L'aération à température élevée a été effectuée en procédé de traitement continu à 30-45°C, dans des unités d'aération de l'ordre de 10 m<sup>3</sup> avec un temps de rétention nominal de 5 jours. L'hygiénisation a été améliorée en dépit de dysfonctionnements. L'hygiénisation à température élevée s'accompagne d'une inhibition de Clostridia.

Mots-clés : acide butyrique, clostridia, microorganismes entériques, prairie, hygiène, déjections.

## 1. Introduction

Cattle slurry formed during an indoor feeding period of 7-9 months should be utilized as fertilizer for grass because cereal production is very limited in Finnish cattle breeding areas. Grass with two harvests in a growth season is usually cultivated 3-4 years in the same plot. Thus about 1/3 or 1/4 of grassland area are renovated annually and, if slurry is used only on ploughed area, the farmers have difficulties to find place for slurry in spring or summer. The difficulty is still culminated by two facts: first the too early transport with heavy tractor and slurry wagon on agricultural fields, which are very soft in late May - early June after melting of snow, would cause long-lasting damages by compaction the soil and thus high reductions of yields and, secondly the farmers are very busy due to the short possible sowing time.

The farmers would like to spread slurry therefore also on growing grass after the first harvest on cut silage grass (in late June), if it would be possible and acceptable hygienically. The hygiene of treated slurry as grass fertilizer has been doubted due to butyric acid producing clostridia, because hard cheeses (mainly Swiss and Edam cheese) fermentation is very important for Finnish dairies and butyric acid producing clostridia destroy very easily the propionic acid fermentation. In addition, extra care for hygiene should be paid because many farms use own wells for drinking waters and sanitary waste waters are often led to slurry tanks and the enteric microorganisms may survive better in Finnish cold and rainy climate.

Hygienization of slurry was studied by aeration done either at low or high temperature with the aim to see if slurry could be used as fertilizer for grassland. Grass is then made for silage and this for hard cheese milk. The possibility to use anaerobic process was rejected because anaerobic process at mesophilic area may not reduce enteric microorganisms effectively (Martens et al., 1998). This may be because, the enteric microorganisms must have a special survival in anaerobic environment because their natural place, the intestinal channel, is highly anaerobic. In addition, anaerobic process at thermophilic area in farm size tanks would need much of extra heating because temperatures such as - 35°C are usual during Finnish winter and very large tanks common to many farmers are not easy because Finnish farms often situate far from each others and transporting of slurry in winter (through ice and snow) would not be easy.

## 2. Materials and methods

Aeration processes have been tested in farm scale either as batch aerations in open tanks of 200-700m<sup>3</sup> the temperature beginning often from 0°C and ending typically to 20-30°C or as continuously operating processes at 30-50 °C in aeration units of about 10 m<sup>3</sup> with theoretical retention time of 5 days. Aerations were done by propeller aeration pumps 2.2-2.5 kW with axis lengths of about 2.5 m. If large

aeration tanks were used, there were 1-3 pumps in a tank according to the size of tank. The pumps used were usually from Hesver, Finland or Pakola, Finland. The aerations at high temperature were done with the pumps of Hesver. A foam cutter (Hesver, Pakola or farm-own-constructions) about 0.1 kW has found to be needed. Most of the batch aerations at low temperature were carried by private farmers (together more than 20 farms) and some by experimental farms. Batch aerations took usually 3-4 weeks. The continuous processes in thermoisolated and covered tanks were carried in two private farms. The slurry samples were send to laboratory with an express coach, so that the laboratory analysis work could be started in the same or next day.

A laboratory test at high temperature was done in water bath and using aquarium pump.

Hygienization has been followed by determination of DNA- and RNA-coliphages (*E. coli* ATCC 13706 and 15597 as hosts) according to the method of Adams (1959) with modification of Rajala-Mustonen and Heinonen-Tanski (1994), total coliforms were cultivated on m-ENDO-agarLES (Difco 0736-17-2; Finnish standard SFS 3016), faecal coliforms on mFC-agar (Difco, 0677-17-3; Finnish standard SFS 4088), enterococci on KF-streptococcus agar (Oxoid CM701) and colonies confirmed with 3 % H<sub>2</sub>O<sub>2</sub> and on bile-aesculin-azid agar (Difco 0525-17; Finnish standard SFS 3014), sulphite reducing clostridia according to European Norm on media self-made (EN 26461) but incubated in Oxoid anaerobic jar and butyric acid producing clostridia with the method described by Jonsson (1989). The Finnish standard methods used base on international water hygiene methods.

### 3. Results

Hygienization in some aeration processes can be seen in the Table 1. The results of batch aeration describe one aeration process made in an experimental farm. In this case the temperature increased from 0 to 19°C. Many other aeration processes, where temperature increased from 0 to 20-30°C, would have given similar results (all data not shown) with 1-3 log reductions for non-sporulating microorganisms.

The continuous processes were followed during two winters in indoor feeding periods of the calendar year 1997. The results are geometric means of six or three determination times in farms 1 and 2, respectively. The temperatures in aeration tanks varied from 32 to 50 °C (farm 1) and from 25 to 33°C (farm 2). The flow in the farm 1 was much more laminar and more successful (fewer interruptions) than it was in the farm 2.

Microorganism	Batch aeration		Continuously processes			
	before	after	Farm 1		Farm 2	
			before	after	before	after
DNA-coliphages	$3.2 \cdot 10^5$	$1.2 \cdot 10^3$	130	13	$3.4 \cdot 10^4$	$3.1 \cdot 10^3$
RNA-coliphages	$2.6 \cdot 10^5$	$2.3 \cdot 10^3$	410	15	700	200
total coliforms	$2.7 \cdot 10^5$	$9.3 \cdot 10^3$	$7.0 \cdot 10^4$	$1.7 \cdot 10^3$	$1.2 \cdot 10^6$	$4.6 \cdot 10^4$
faecal coliforms	$3.2 \cdot 10^4$	$2.1 \cdot 10^3$	$1.2 \cdot 10^5$	$1.6 \cdot 10^3$	$1.0 \cdot 10^6$	$5.1 \cdot 10^3$
enterococci	$1.5 \cdot 10^5$	$1.0 \cdot 10^4$	$9.7 \cdot 10^5$	$4.2 \cdot 10^4$	$8.3 \cdot 10^4$	$2.9 \cdot 10^4$
SRC	$3.8 \cdot 10^4$	$1.9 \cdot 10^4$	$4.6 \cdot 10^3$	$1.3 \cdot 10^3$	$1.5 \cdot 10^4$	$2.6 \cdot 10^4$
BPC	$4.5 \cdot 10^6$	$3.5 \cdot 10^5$	$1.6 \cdot 10^4$	$1.1 \cdot 10^4$	$3.2 \cdot 10^4$	$2.0 \cdot 10^4$

Table 1.

The numbers of DNA- and RNA-coliphages, total coliforms, faecal coliforms, enterococci, sulphite reducing clostridial spores (SRC) and butyric acid producing clostridial spores (BPC) in three aeration processes.

Parameter	Aeration 1	Aeration 2
Temperature °C	50-59	56-66
Mean temp. °C	53.6	60.5
Redox potential mV	104	104
Clostridial density at the start	$8.6 \cdot 10^4$	$6.8 \cdot 10^4$
Clostridial density at the end	$3.6 \cdot 10^4$	780

Table 2.

The number of butyric acid producing clostridial spores in 3 days' laboratory test with temperatures and redox potential in two high-temperature aerations.

## 4. Discussion

The results suggest that farm scale aeration could improve the hygiene of slurry. Some risks caused by enteric, non-sporulating microorganisms can be reduced already if aeration is done at low temperature (less than 30°C) to save nitrogen - and aerations costs. The costs in this decade including capital for aeration apparatus and electricity at low temperature would be about 1.2 - 1.5 ECU/m<sup>3</sup> slurry (Haataja, 1998). The nitrogen losses typically have been about 10% (Leinonen *et al.*, 1998). Slurry could thus be used for fertilization of growing grass and spreading done either in spring for first harvest or in summer for second harvest. In both of these cases the sun radiation may still hygienize the grass during the growth.

The aeration at high temperature may destroy also spores of butyric acid producing clostridia so efficiently that the further contamination for silage or milk could be reducing. The temperature and other environmental factors destroying butyric acid producing clostridia would be important. The aeration at temperature, 56-66 °C, which reduced 2 log *Clostridium tyrobutyricum* and related bacteria should be still so low that according to the review of Mitcherlich and Marth (1984) it should not yet destroy the spores of this bacterial group. Therefore the reduction of this group was not only caused by warm temperature, although the heat has some



effect as seen the results of Table 2. The high redox potential may also be an important factor at least for anaerobic clostridia. Therefore it might be important to study the combine effect of aeration, oxidative chemicals and temperature so that the theory for clostridial death could be better understand.

In practice the aeration of slurry at high temperature may be an alternative. The flow should be laminar and all bypasses avoided. Theoretically (calculated from BOD-reductions), more energy should be forming from heat than what is needed for electricity, but still this theory has not yet been vital. The heat formed could be utilized for instance for pre-heating drinking water of cows, which would allow the cows to drink more and thus to give more milk. We should have more experience so that the missfunctions or surface cover could be avoided. The possible nitrogen losses from aeration could be reduced by using acid peat as biofilter. The theoretical retention time truly needed should also be further studied, especially if sanitary waste waters are also led to slurry tank.

## 5. Conclusion

**5.1.** It is possible to begin the aeration of cattle slurry in large storage tanks also in winter or early spring. The heat formed will melt the ice on the large slurry tank and heat the slurry up to 20-30°C. The reductions of 90-99.9 % for many non-sporulating micro-organisms can be found. The spreading of aerated slurry would be more safe than that of non-aerated, fresh slurry for farmer's occupational health and for public health of the people living in neighbourhood.

**5.2.** The hygienization is still more effective if the aeration of slurry is done in small reactors as continuously operating process and the anaerobic butyric acid producing clostridia dangerous for hard cheese fermentation can also be controlled. The techniques is not yet ready and it would be very important to develop it, so that the flow is laminar in spite of the daily and weekly unevennesses of the load of slurry and the waste waters. This may be very important if the animal breeding units are coming larger as it may be in the future.

## 6. References

**Adams, M. H.** 1959. Bacteriophages. With chapters by E. S. Anderson (and others) Electron micrographs by E. Kellenberger. pp. 592. New York: Interscience Publicers.

**Haataja, K.** 1998. Karjanlannan käytön kannattavuus. (The economy for utilization of animal manure). Maatalouden taloudellisen tutkimuslaitoksen tutkimuksia. (In Finnish) 227, 107-121.

**Jonsson, A.** 1989. Enumeration and confirmation of *C. tyrobutyricum* in silage using neutral red, D-cycloserine and lactate dehydrogenase activity. *J. Dairy Res.* 73, 719-725.

**Leinonen, P., Heinonen-Tanski, H. & Rinne, K.** 1998. Nitrogen economy of cattle slurry aeration and spreading onto grasslands. *Acta Agric. Scand. Sect. B. Soil and Plant Science.* Accepted.

**Martens, W., Fink, A., Philipp, W., Winter, D. & Böhm, R.** 1998. Inactivation of viral and bacterial pathogens in large scale treatment plants. Management strategies for organic waste use in agriculture. *Ramiran 98. Abstract papers.* p. 89

**Mitcherlich, E. & Marth, E. H.** 1984. *Microbial survival in the environment: Bacteria and Rickettsiae important in human and animal health.* pp 802. Berlin: Springer-Verlag.

**Rajala-Mustonen, R. L. & Heinonen-Tanski, H.** 1994. Sensitivity of host strains and host range of coliphages isolated from Finnish and Nicaraguan wastewater. *Wat. Res.* 28, 1811-1815.

## Treatment of animal wastewater in constructed wetlands.

*Traitement des effluents d'élevage à l'aide de zones humides construites.*

**P. G. Hunt, A. A. Szogi, F. J. Humenik, and J. M. Rice.**

USDA-ARS/NCSU, Coastal Plains Soil, Water and Plant Research Center.

2611 W. Lucas St. 29501-1242 Florence, South Carolina. U.S.A.

E-mail : [hunt@florence.ars.usda.gov](mailto:hunt@florence.ars.usda.gov)

### Abstract

*Swine production is a major enterprise in the USA that has monumental waste treatment problems. These problems are related to confined, high density production, flushing of waste to anaerobic lagoons, and the subsequent land application of wastewater. With this treatment method, it is easy to overload an area with nitrogen. One of the alternative treatment methods is the use of constructed wetlands. Our research had two objectives: 1) to better understand the function of constructed wetlands in a total swine waste management system and 2) to assess the ability of wetlands to remove nitrogen and thereby decrease the required land application area. The treatment wetlands consisted of six 3.6-m x 33.5-m cells. Three systems comprised of two cells connected in series were evaluated. A nitrogen loading rate of 3 kg ha<sup>-1</sup> day<sup>-1</sup> was used during the first year of operation, but the rate was increased up to 25 kg ha<sup>-1</sup> day<sup>-1</sup> in the subsequent three years. At the low loading rate, 94 % of the nitrogen was removed, but at the higher loading rates, 80 to 90% was removed.*

Keywords: nitrification, denitrification, soybean, swine, pre-wetland treatment

### Résumé

La production porcine est une industrie majeure aux USA et qui présente de colossaux problèmes de traitement des effluents. Ces problèmes sont liés notamment à la production hors-sol intensive, avec « flushing » des effluents vers des lagunes anaérobies et épandage de ces effluents. Avec ce mode de traitement il est aisé de surdoser les terres en azote. Notre recherche poursuit deux objectifs : (i) mieux comprendre les fonctions de zones humides aménagées dans un système total de gestion des effluents porcins et (ii) évaluer la faisabilité de zones humides à éliminer de l'azote et ainsi à réduire les surfaces nécessaires pour l'épandage. Les zones humides construites consistent en six unités de 3,6 m x 33,5 m. Trois systèmes comprenant ainsi deux unités connectées en série ont été étudiés. Une charge en azote de 3 kg ha<sup>-1</sup> j<sup>-1</sup> a été appliquée la première année de fonctionnement mais ce taux a été augmenté à 25 kg ha<sup>-1</sup> j<sup>-1</sup> au cours des 3 années suivantes. Aux doses d'apports faibles, plus de 94% de l'azote est éliminé, alors que pour les doses plus importantes, 80 à 90% de l'azote est éliminé.

Mots-clés : nitrification, dénitrification, soja, porc, pré-traitement zone humide.

## 1. Introduction

Swine production is an important part of the US agricultural economy that has shifted from small private production to large, confined, corporate production. This industrial production of swine generates large amounts of waste. Currently, most enterprises apply both solid and liquid waste to forage and crop land. Land application of waste becomes a problem when more manure nitrogen is produced than crop or forage land can assimilate. Consequently, public concern and changing environmental regulations are stressing the need for alternative treatment methods that require less land area for manure treatment. These alternative methods include constructed wetlands (Hunt et al., 1995b).

Wetlands have been successfully used for advanced treatment of municipal and residential wastewaters in the USA and around the world for over three decades (Kadlec and Knight, 1996). Compared to conventional systems, they have 1) less - construction, operation, and energy costs and 2) more - flexibility in pollutant loading. They can be built on aerated upland soils; the necessary hydric soil conditions and aquatic plant life will develop when the soils are flooded. Two types of wetlands are typically used: subsurface and water-surface-flow (Hammer, 1989). Subsurface systems are subject to clogging and limited oxygen diffusion. Consequently, research on constructed wetlands for animal waste treatment in the USA has focused on water-surface-flow systems with emergent plants (Cathcart et al. 1994; McCaskey et al. 1994; Payne Engineering and CH2M Hill, 1997).

Our research had two objectives: 1) to better understand the function of constructed wetlands in a total swine waste management system, and 2) to assess the ability of wetlands to remove nitrogen and thereby decrease the required land application area.

## 2. Materials and Methods

The research site, a 2,600-pig nursery (average weight = 13 kg) in Duplin Co., NC, USA, used a flushing system to recycle liquid from a single-stage lagoon. The average liquid volume of the lagoon was 4,100 m<sup>3</sup>. Typically, the lagoon liquid contained 365 mg L<sup>-1</sup> TKN (> 95% NH<sub>3</sub>-N), 93 mg L<sup>-1</sup> TP, and 740 mg L<sup>-1</sup> COD.

Six 3.6- by 33.5-m wetland cells were constructed adjacent to the treatment lagoon in 1992. The wetland cells were built by soil excavation. Cell bottoms were graded to a 0.2% slope and sealed by a compacted clay liner. The clay liner was covered with a 0.25-m layer of loamy sand soil.

Wetland cells were planted either to a polyculture of natural wetland plants or to water-tolerant agronomic plants. Three systems were evaluated; each consisted of two cells connected in series. System 1 contained rush (*Juncus effusus*) and

bulrush (*Scirpus americanus*, *Scirpus cyperinus* and *Scirpus validus*); system 2 contained bur-reed (*Sparganium americanum*) and cattails (*Typha angustifolia* and *Typha latifolia*). System 3 consisted of one cell that contained soybean (*Glycine max*) grown in saturated-soil culture connected to a second cell that contained flooded rice (*Oryza sativa*). Six soybean cultivars were planted in replicated microplots within system 3 each year (1993 - 1996).

Water level at the end of each cell of the two wetland plant systems and the flooded rice cell was maintained at about 150 mm. In system 3, soybean in saturated-soil culture was planted on 1.4-m-wide beds that were surrounded by approximately 100 mm-deep ditches. Water level in the ditches was held at about 50 mm below the bed surface.

Flow was measured by use of six V-notch weirs and six ultra-sonic flow meters at the inlet and outlet of each system. In addition, tipping bucket flowmeters with mechanical counters were used on the inflow as a backup to the ultra-sonic flow meters. Seven automated water samplers were installed. One sampler took samples of the wastewater inflow, and the other six sampled the water at the end of each single cell. The water sampler combined samples into three-day composites. A data logger with three multiplexers was installed for hourly acquisition of weather parameters and soil redox potential (Eh) data. Soil redox potential was monitored with a total of ninety Pt electrodes. Electrodes were arranged in clusters of five electrodes; three clusters were installed per cell with one Ag/AgCl reference electrode per cluster.

In order to prevent potential damage to wetland plants, wastewater was initially diluted with fresh water and applied at a N rate of  $3 \text{ kg ha}^{-1} \text{ day}^{-1}$ . This low, daily, N application rate required a high dilution rate (1:15) in order to maintain the hydraulic conditions of a wetland (i.e., wastewater diluted to  $25 \text{ mg L}^{-1} \text{ N}$  provides  $3 \text{ kg ha}^{-1} \text{ day}^{-1}$  of N with a loading depth of only  $12 \text{ mm day}^{-1}$ ). Since 6-mm hydraulic loading would not meet evapotranspiration demands during the summer months, the fresh water dilution and hydraulic loading were increased as needed to maintain the wetland outflow and the  $3 \text{ kg ha}^{-1} \text{ day}^{-1}$  N application rate. The dilution rates were decreased when higher N loading rates were applied in subsequent years. The N loading rates were increased to 8, 15, and  $25 \text{ kg ha}^{-1} \text{ day}^{-1}$  in the subsequent three years. Wastewater was not applied to the soybean and rice cells after grain maturity.

Wetland plants were sampled each month, during the growth season, from three  $0.25\text{-m}^2$  quadrats chosen at random along each wetland cell. Samples were transported in plastic bags to the laboratory where living and dead tissues were separated within 24 hrs. Plant materials were oven-dried at  $60^\circ\text{C}$  to constant weight. Oven-dried weights of living and dead tissues were used to estimate the net dry matter productivity according to Kirby and Gosselink (1976). Soybean and rice were harvested at maturity, oven-dried, threshed, and weighted for grain yields.

Plant material subsamples were ground and digested using a block digestion technique. Digestates were analyzed for nitrogen using a TRAACS 800 Auto-Analyzer<sup>1</sup>. Water samples were analyzed for NO<sub>3</sub>-N, NH<sub>3</sub>-N, and TKN in accordance with the USEPA recommended methodology by use of a TRAACS 800 Auto-Analyzer (Kopp and McKee, 1983).

Denitrification enzyme assays were done on disturbed soil samples by the acetylene blockage method (Tiedje, 1982). Measurements were made on soil samples that were both unamended and amended with nitrate, glucose, or nitrate plus glucose. They were incubated under both aerobic and anaerobic conditions.

A microcosm wetland study with 18 cells was established to assess pre-wetland nitrification. Each of the 18 microcosm cells had a surface area of 1 m<sup>2</sup> (2.0 m x 0.5 m). Each cell was lined with PVC film, filled with sandy loam topsoil to a depth of 22 cm, and planted to a mixture of *Scirpus validus* and *Juncus effusus*. The treatments were three C sources: soil with wetland plants, soil with no plants (control), and soil + C source (glucose amended) with no plants. Nitrified wastewater was applied at full strength and 50 % diluted. The experiment was a 3 x 2 factorial (six treatments) in a randomized block design with three replications per treatment. Wastewater enriched with nitrate was applied to the microcosm wetland units at a rate of 190 kg nitrate-N/ha with a retention time of four days.

### 3. Results and Discussion

Growth was good for wetland and agronomic plants (Table 1). Although the > 200 kg ha<sup>-1</sup> yr<sup>-1</sup> of N accumulated by plants would be significant for the nutrient balance of an agronomic system, it was a relatively small portion of the total nutrient load to the wetlands. Nevertheless, plants were vitally important in the treatment wetland systems. Their stems transported oxygen into sediment; their residues contributed organic carbon and surfaces for microbial process.

Soybean seed yields ranged from 0.8 to 4.4 Mg ha<sup>-1</sup> during 1993 -1996 for the cultivar 'Young.' These yields were low compared to the > 5 Mg ha<sup>-1</sup> soybean yields obtained in Australia using saturated-soil culture (Lawn and Byth, 1989). Rice yields were similarly moderate with a mean of 3.7 Mg ha<sup>-1</sup>. At the 3 and 8 kg N ha<sup>-1</sup> day<sup>-1</sup> loading rates, N reduction by the soybean-rice system was comparable to the wetland plants. However, once they were mature, they required dry conditions for harvest. Weed invasion during the off season was also a problem. Nonetheless, the results show that the saturated-soil culture soybean and rice system can be used in the treatment of swine wastewater.

---

<sup>11</sup> Mention of a trademark, proprietary product, or vendor is for information only and does not constitute a guarantee or warranty of the product by the U.S. Department of Agriculture and does not imply its approval to the exclusion of other products or vendors that may also be suitable.

Plants	Dry matter	N uptake
	Mg ha <sup>-1</sup>	kg ha <sup>-1</sup>
<i>Scirpus/Juncus</i>	19	338
<i>Typha/Sparganium</i>	23	428
Soybean*	7	222
Rice	10	216

\*Soybean and rice total dry matter production at harvest = grain + stalks.

Table 1.

*Dry matter and nitrogen uptake for plants in the wetlands during 1993 and 1994.*

Nitrogen removal efficiency was similar in both rush/bulrushes and cattails/bur-reed plant systems (Table 2). At a N loading of 3 kg ha<sup>-1</sup> day<sup>-1</sup>, a mass N reduction of 94% was obtained. During the second year, the N loading rate was increased to 8 kg ha<sup>-1</sup> day<sup>-1</sup>, and mass N reduction was 87%. In the third year, the loading rate was doubled to 15 kg N ha<sup>-1</sup> day<sup>-1</sup>, and removal efficiency was 83%. During 1997, the removal rates did not decrease even though the application rate was 25 kg N ha<sup>-1</sup> day<sup>-1</sup>. At this rate and 300 application days, wetlands could remove >6 Mg N ha<sup>-1</sup> yr<sup>-1</sup>. These high rates of nitrogen removal were likely due to denitrification of NO<sub>3</sub>-N that was formed in the upper portion of the liquid layer (Szogi and Hunt, unpublished data). However, some loss of NH<sub>3</sub>-N by volatilization cannot be disregarded.

Nitrogen Load kg ha <sup>-1</sup> day <sup>-1</sup>	System	
	Rush/bulrush Mass Removal, %	Cattails/bur-reed
3	94	94
8	88	86
15	85	81
25	90	84

% Mass Removal = % mass reduction of N (NH<sub>3</sub>-N + NO<sub>3</sub>-N) in the effluent with respect to the nutrient mass inflow.

Table 2.

*Mass removal of N in constructed wetlands, NC, USA (June 1993–November 1997).*

Anaerobic conditions were prevalent in the wetland soils. We found Eh at the 20-mm soil depth in the first cells to be consistently below 100 mv (Fig. 1). The second cells were similarly reduced except on the occasions when the hydraulic load was limited. This indicated that nitrification was likely limited and that denitrification was predominant. However, the main form of N in the wastewater is ammonia, which requires nitrification before denitrification. The lack of ammonia-N removal via nitrification has been identified as the cause of failure for many municipal wetland systems (Reed, 1993). Thus, it would be likely to find that denitrification was nitrate limited. This assumed limitation was tested by Denitrification enzyme assay (DEA) in order to ascertain that nitrate was the most limiting factor for denitrification in the wetland cells.

DEA results were as expected; the wetlands were nitrate limited (Fig. 2). Denitrification was greatly increased by additions of nitrate-N. Conversely, it was not greatly increased by glucose addition. Thus, it is reasonable to expect that the overall rate of N removal could be increased by pre-wetland nitrification. This nitrification would also eliminate the need for dilution in order to avoid ammonia-N damage to wetland plants and potential losses by ammonia volatilization. We are currently investigating several promising approaches to nitrification of swine wastewater (Vanotti et al., 1998; Vanotti and Hunt, 1998).

We confirmed the hypothesis that large amounts of nitrogen ( $49 \text{ kg ha}^{-1} \text{ day}^{-1}$ ) could be removed from wetlands if pre-nitrified wastewater was added (Fig. 3). The nitrate-N application rates of 26 and  $49 \text{ kg ha}^{-1} \text{ day}^{-1}$  are very high application rates relative to those possible with agronomic crops. We also confirmed the hypothesis that wetland plants would be required to provide the carbon for denitrification. Both the wetland and carbon-amended soil treatments were very effective in the mass removal of N; 80% of the applied N was removed. In contrast, the control (soil) treatment with no plants was very ineffective; only 14% of the applied N was removed.

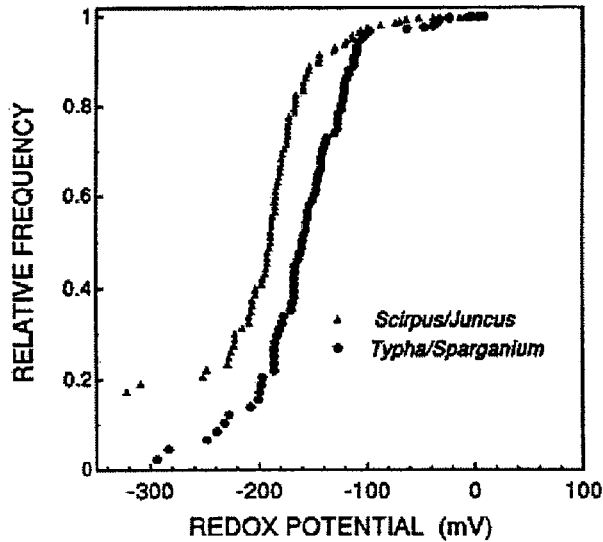

Figure 1  
Relative frequency of daily redox potentials at 20 mm depth in soils of constructed wetlands during growing season.



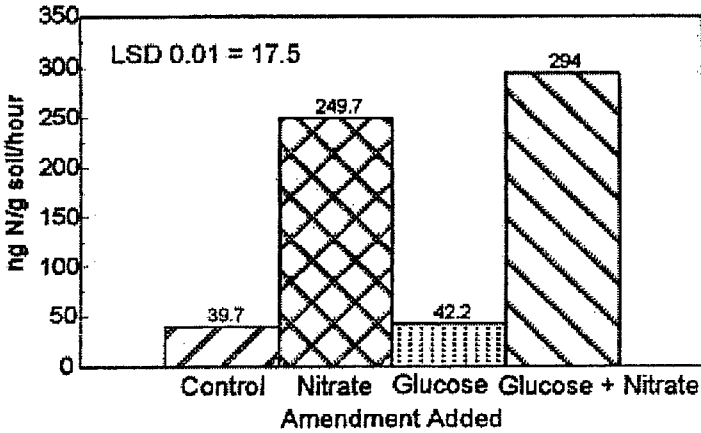

Figure 2  
Mean denitrification potential as influenced by soil amendment.

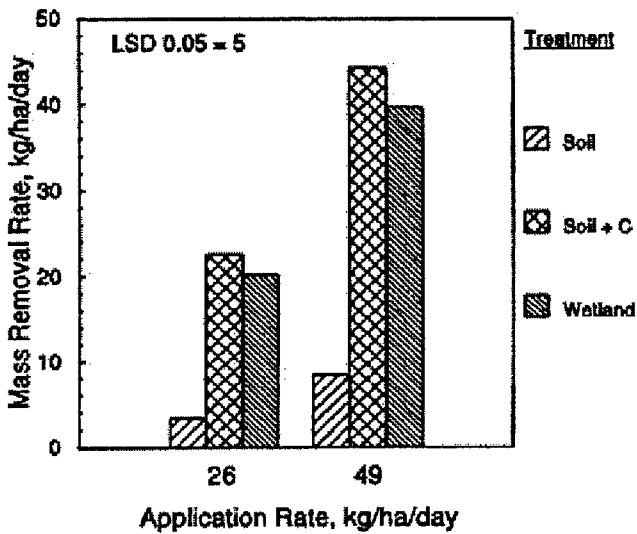

Figure 3  
Nitrogen removal from wetlands microcosms with three types of carbon regimes and batch wastewater applications every four days.

#### **4. References**

- Cathcart, T.P., D.A. Hammer, and S. Triyono.** 1994. Performance of a constructed wetland-vegetated strip system used for swine waste treatment. p. 9-22. In P.J. DuBow and R.P. Reaves (eds.) *Constructed Wetlands for Animal Waste Management*. Purdue Research Foundation, West Lafayette, IN.
- Hammer, D.A. (ed.)** 1989. *Constructed Wetlands for Wastewater Treatment: Municipal, Industrial, and Agricultural*. Lewis Publishers, Chelsea, MI. 831 p.
- Hunt, P.G., W.O. Thom, A.A. Szögi, and F.J. Humenik.** 1995b. State of the art of animal wastewater treatment in constructed wetlands. p. 87-97. In C.C. Ross (ed.) *Proceedings of the Seventh International Symposium on Agricultural and Food Processing Wastes (ISAFPW95)*. June 18-20, 1995, Chicago, IL. ASAE Publication 7-95, St. Joseph, MI.
- Kadlec, R. H., and R. L. Knight.** 1996. *Treatment wetlands*. Lewis Publishers, Boca Raton, FL. 893 p.
- Kirby, C.J., and J.G. Gosselink.** 1976. Primary production in a Louisiana gulf coast *Spartina alterniflora* marsh. *Ecology* 57:1052-1059.
- Kopp, J.F., and G.D. McKee.** 1983. *Methods for chemical analysis of water and wastes*. USEPA Report No. EPA-600/4-79020. Environmental Monitoring and Support Lab., Office of Research and Development, U.S. Environmental Protection Agency, Cincinnati, OH. 521 p.
- Lawn, R.J., and D.E. Byth.** 1989. Saturated soil culture. A technology to expand the adaptation of soybean. p. 576-581. In A.J. Pascale (ed.) *IV World Soybean Research Conference*. Publ. Realizacion, Orientacion Grafica Ed. SRL, Buenos Aires, Argentina.
- McCaskey, T.A., S.N. Britt, T.C. Hannah, J.T. Eason, V.W.E. Payne, and D.A. Hammer.** 1994. Treatment of swine lagoon effluent by constructed wetlands operated at three loading rates. p. 23-33. In P.J. DuBow and R.P. Reaves (eds.) *Constructed Wetlands for Animal Waste Management*. Purdue Research Foundation, West Lafayette, IN.
- Payne Engineering and CH2M Hill.** 1997. *Constructed wetlands for animal waste treatment*. Report prepared for the EPA's Gulf of Mexico Program; pub. Alabama Soil and Water Conservation Committee, Montgomery, AL.
- Reed, S.C.** 1993. *Subsurface flow constructed wetlands for wastewater treatment: Technology assessment*. EPA-832-R-93-001. Office of Water, USEPA, Wash., DC.

**Tiedje, J.M.** 1982. Denitrification. In A.L. Page, R.H. Miller, and D.R. Keeney (eds.) *Methods of Soil Analysis. Agronomy 9 (Part 2):1011-1026.*

**Vanotti, M.B., A.A. Szögi, P.G. Hunt, F.J. Humenik, and J.M. Rice.** 1998. Nitrification options for swine wastewater treatment. *Proc. Animal Production Systems and the Environment: An International Conference on Odor, Water Quality, Nutrient Management, and Socioeconomic Issues.* Iowa State Univ., July 19-22, Des Moines, IA.

**Vanotti, M. B., and P. G. Hunt.** 1998. Ammonia removal from swine wastewater using immobilized nitrifiers. In *Ramiran 98, Proceedings of the 8th International Conference on Management Strategies for Organic Waste Use in Agriculture.* 26-29 May 1998. Rennes. France. Martinez J., Maudet M.N. (eds). *FAO-Cemagref Editions.* 427-432.



## **The new ABS composting process : application to the pilot unit of stan at Castelnaudary (France).**

*Le nouveau procédé de compostage ABS : application au pilote industriel de Stan à Castelnaudary (France).*

**O. Leclerc, J.L. Martel, I. Vendevre**

SITA group. Technopôle CNPP. BP 2265. Route de la Chapelle-Réanville.

27950 - SAINT MARCEL. France

Tel : 02 32 53 63 40. Fax : 02 32 53 63 44.

E-mail : Jean-Luc\_MARTEL@sita.fr

### **Abstract**

This paper describes the industrial pilot unit of Castelnaudary, built in 1997, and gives the main characteristics of the ABS composting process that was developed by the SITA group through the EUREKA VALORBIO program and with financial assistance of ADEME. The structure of the pilot unit and the three different phases of processing (initial mixing, fermentation, refining) are described. The technical ratios of the process : minimal dry matter content of input products, minimal batch quantity treated per solt, mixing ratio with bulking agents, temperature evolution and monitoring etc... are given. Results of the scientific monitoring on urban sludge and pig-manure sludge are briefly shown. The agronomical, environmental and sanitary qualities of the refined composts are given and compared to those of the input products. The different liquid and gaseous (before and after biofiltration) fluxes produced by the pilot plant have been studied.

### **Résumé**

Cet article décrit le pilote industriel de Castelnaudary, construit en 1997 et décrit les principales caractéristiques du process de compostage ABS développé par le groupe SITA dans le cadre du programme de recherche EUREKA VALORBIO et avec la participation financière de l'ADEME. La structure de l'unité pilote et les différentes phases de mise en oeuvre du process (mélange initial, fermentation, affinage) sont décrits. Les ratios techniques du procédé : taux minimal de matière sèche des produits à traiter, quantités minimales traitées par lot, ratio de mélange avec les agents structurants, évolution et contrôle de la température sont indiqués. Les résultats du suivi scientifique opéré sur les boues urbaines et sur les boues de lisier de porc sont brièvement décrits. Les qualités agronomiques et environnementales ainsi que le niveau d'hygiénisation des composts produits sont fournis et comparés à ceux des produits bruts initiaux. Les condensats et les différentes émissions gazeuses (brutes ou épurées par biofiltration) ont été étudiés et analysés.

## **Introduction**

This paper describes the characteristics of the ABS composting process that was developed by the SITA group through the EUREKA VALORBIO program with financial contribution of ADEME.

The pilot unit of CASTELNAUDARY, first application of the ABS process, is operated by STAN, a regional subsidiary of SITA France. Some results of the scientific follow up lead on sewage and pig manure sludges are given

### **1. Objectives**

The SITA group, first european and third world waste operator, is strongly involved in biological treatments development.

It launched in 1993 the VALORBIO european research program; this program was dedicated to the co-composting and anaerobic fermentation of different wastes like biowaste, sewage and industrial food sludges, grease, agricultural waste and green waste.

Sludge and various waste mixing and co-composting trials and market studies on industrial food waste have been realized in 1994 and 1995.

According to the lack of processes being able to answer to the needs of the SITA group and of its customers, it was decided to developpe a new corridor process giving all the garanties on traçability from the input products to the end products, on effective pathogens reduction, and on delivery of an odorless, biologically dried and good looking screened compost.

So, the first industrial pilot unit applying the new process ABS has been designed in 1996 and built in 1997 at CASTELNAUDARY, in the department of AUDE, eighty kilometers away from TOULOUSE.

### **2. Description of the ABS process**

This process alternates long periods of static composting with forced ventilation controlled sytem and short periods of quick turn over and move of mixed materials along one corridor that is dedicated to the treatment of one kind of waste.

It can be divided into three phases:

a) initial mixing between input waste and bulking agents

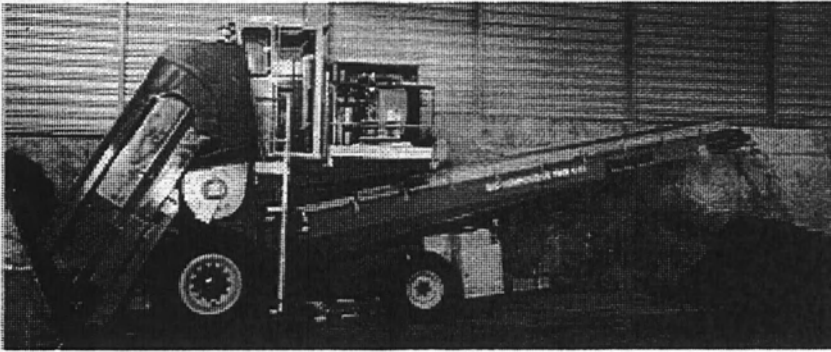
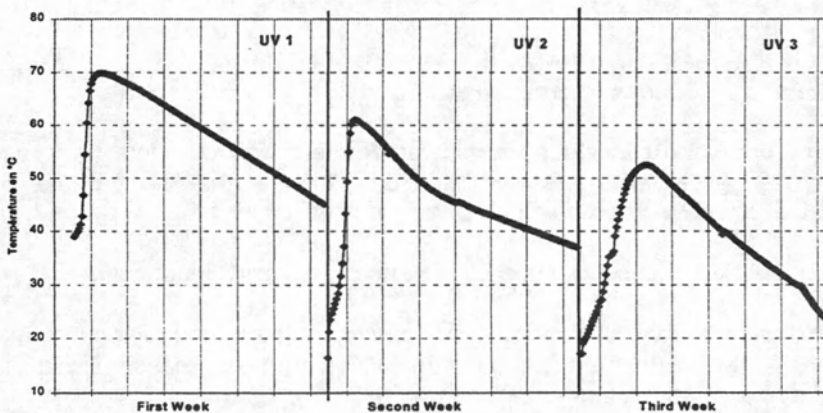

*photo1*

The special machine, called a “biocomposteur”, and shown on photo1, is used for initial mixing by running through a mixing corridor where successive beds of sludge and bulking agents have been previously laid down by a front loader.

b) Active fermentation period under controlled ventilation

After initial mixing, the industrial batch of 120 m<sup>3</sup> is picked up and laid down into the first part of a fermentation corridor for a first week of active composting. Temperature of the mixed materials increases first quickly then decreases slowly, as showed on graph 1. After one week, the “biocomposteur” runs through the corridor and moves the batch to the following part of the corridor



*Graph1 : Evolution of exhaust air temperature*

c) refining period

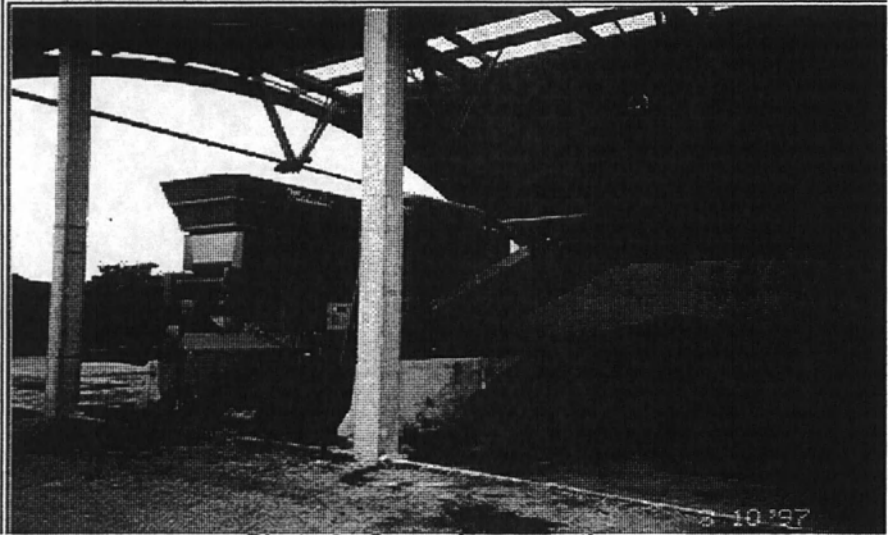

**Photo 2 : Screening operation**

After three weeks or more of active fermentation, the output products are biologically dried and can be immediately screened after the last passage of the "biocomposteur".

Fine compost enters the maturation phase of, at least, forty five days and coarse materials are reused as bulking agents .

### **3. Presentation of the pilot unit of Castelnaudary**

The pilot unit has a treatment capacity of 6,400 tons of input waste per year (4,000 tons of sludge and 2,400 tons of green-waste).

One mixing corridor and two sludge dedicated fermentation corridors have been built indoors, one green waste fermentation corridor and the two process and ambient air biofilters have been built outdoors.

The sludge reception and mixing areas have been closed and deodorized.

The future expansion, that will be able to treat more than 24,000 tons of input waste per year, will have thirteen fermentation corridors, three process air biofilters and four ambient air biofilters, as shown on photo 3.



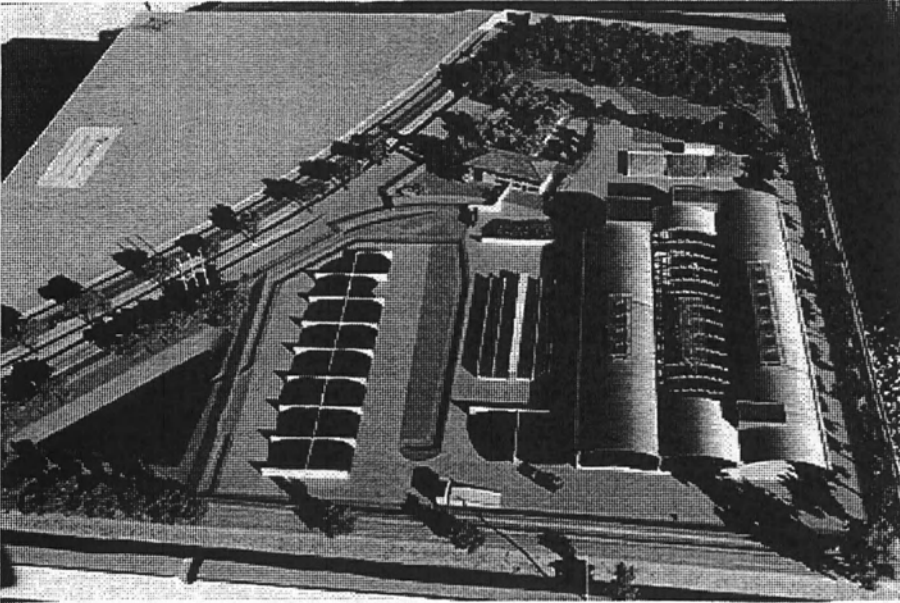

*Photo 3 : global view of the future expansion*

#### **4. Application to the treatment of sewage and pig manure sludges**

Among the different wastes treated in the pilot unit, Castelnaudary sewage sludge and local pig manure sludge have been composted several times. The main results collected by the scientific follow up are shortly reported.

##### **a) Fermentation parameters**

- The treatment capacity for such sludges is 1,800 to 2,000 tons of wet product per year and per corridor, that is to say that each week, one corridor can enter a batch containing 40 tons of sticky sludge and treat it in three weeks.
- High temperatures (above 60°C) are reached and lead to an important decrease of microbiological pathogenic population in the composted products. Results obtained with sewage sludge are shown in Table 1.

Parameter	Units	Sewage sludge	Sludge compost	Reduction	Arrêté 8.01.98
Enterovirus	/100 g DM	20	2	1 log	< 30 NPPUC/100 g
Streptococcus (D group)	/g DM	400 000	2 000	2 log	
Total coliforms 30°C	/g DM	2 000 000	1 000	3 log	
Fecal coliforms 44°C	/g DM	1 000 000	< 10	5 log	
Escherichia coli	/g DM	400 000	< 10	4 log	
Staphylococcus	/g DM	< 10	< 10		
Clostridium perfringens	/g DM	200 000	100	4 log	
Salmonella	/25 g DM	Absence	Absence		< 8 NNP / 10 g
Nematodes larvae	/g DM	Absence	Absence		
Nematodes viable eggs	/g DM	Absence	Absence		< 3 / 10 g

**Table 1**  
*Evolution of microbiological populations from sewage sludge to compost*

b) refining parameters

With mesh screen of 8 millimeters, it is possible to obtain a low quantity of sewage sludge compost, by evaporating an important part of water hold in sludge. Technical ratios are shown in table 2.

	Sewage sludge	Pig manure sludge
Compost production/ton of sludge	230-270 kg	430-530 kg
Bulding agents mass recycling rate	65-76%	70-80%
Water quantity removed/ton of sludge	550-650 l	500-550 l

**Table 2**  
*Technical ratios about mass balance*

c) agronomic qualities of composts

We can see on graphs 2 and 3, the evolution of rough wastes to composted products:

The dry matter content moves from 17% to 55% in sewage sludge compost and from 25% to 55% in pig manure compost.

50% of nitrogen are lost during sewage sludge composting, the important loss of phosphorus in pig manure compost must be attributed to a false analysis (we dispose of one only).

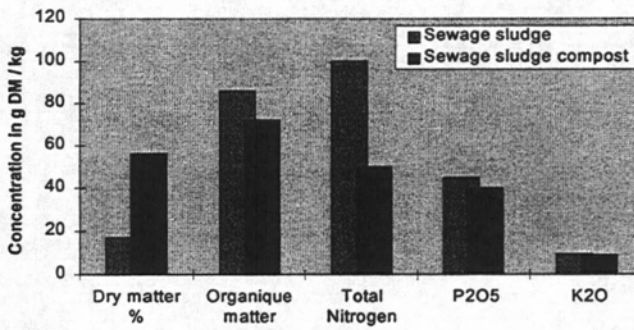
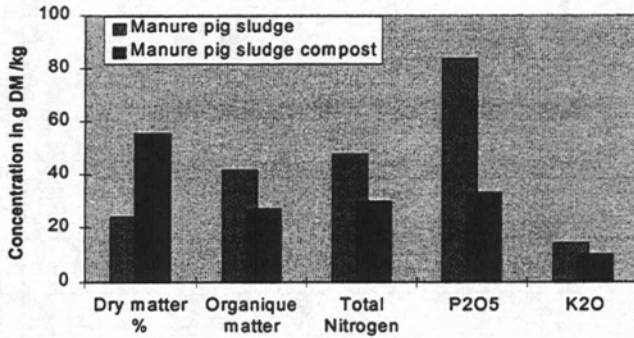

*Graph 2 and 3  
Evolution of sewage and pig manure sludges to compost*

The heavy metals concentrations in sewage and pig manure compost are very low as shown in Table 3.

		Sewage sludge	Pig manure	Arrêté
		Compost	Compost	08/01/98
Cd	mg/kg	0,7	0,4	10
Cr	mg/kg	74,4	12,7	1000
Cu	mg/kg	156,5	100,3	1000
Hg	mg/kg	1,0	<0,32	10
Ni	mg/kg	19,2	< 10,7	200
Pb	mg/kg	53,1	9,2	800
Se	mg/kg	1,3	1,5	100
Zn	mg/kg	396,1	446,7	3000

*Table 3  
Heavy metals concentration in final products (/DM)*

## 5.Environmental impact of the pilot unit

### a) liquid effluent production

The production varies between 25 and 50 liters per ton of sludge, it is equivalent to 125 to 250 liters per day and per corridor, this important difference can be explained by variation of climatic conditions that influence condensation of water vapour inside the ventilation system.

The average effluent COD squares with 0,8 to 1,5 equivalent habitant per fermentation corridor.

### b) gaseous effluent production

The NH<sub>3</sub> concentration in exhaust air varies from 300 to 600 ppm, this concentration is reduced by 90% through biofilter.

Some air analysis that have been sampled at the limit of the pilot unit give the following results :

	NH <sub>3</sub>	H <sub>2</sub> S	RSH
Maximal value Under wind (mg/Nm <sup>3</sup> )	< 0,0038	< 0,012	< 0,003
Maximal value Allowed by order of the Prefect	< 5	< 0,1	< 0,07

## 6. Conclusion

Initial objectives are achieved by delivering an odorless, dried and good looking product only after 3 weeks of treatment through the ABS process.

Low environmental impact of the pilot plant unit has been demonstrated and allows future expansion.

Agronomic quality of the refined composts has to be tested by growing trials. These trials will begin in June with pots growing tests and will be completed by plots growing tests in association with local partners.



## Liquid pig manure treatment in a farm plant : fate of polluting elements before and during storage in a shallow lagoon.

*Traitement du lisier de porc à la ferme : devenir des éléments polluants avant et au cours du stockage en lagunes peu profondes.*

**L. Senez, Y. Couton, C. Devroe, J.C. Germon**  
INRA-CMSE,  
Laboratoire de Microbiologie des Sols,  
17 rue Sully, 21034 Dijon Cedex

**J.P. Lemièrre, J.C. Coquille**  
ENESAD, Laboratoire des Agro-  
équipements et des Procédés,  
Bd O. de Serre, 21800 Quétigny

### Abstract

*The treatment scheme is based on centrifuge sieving, decantation-biodegradation in two shallow lagoons and finally land spreading. The fate of potentially polluting elements (organic carbon, nitrogen, phosphorus, Zn and Cu) was studied all along the treatment process. Centrifuge sieving capacity is 22.4 m<sup>3</sup>.h<sup>-1</sup> and is able to remove 42.9% of the dry matter and 26.5% COD, but only 4.8 % total N and 9% of P, Cu and Zn. From the 38.4 t N year<sup>-1</sup> entering in the first lagoon, 6.3 t settle in the sediment and 7.6 t are eliminated by ammonia volatilization and/or nitrification-denitrification ; the respective part of each mechanism is not defined. The sediments collected in the lagoon contained, on average, 3.3 % N, 5.5 % P on dry matter basis. However Cu and Zn contents are higher than 0.1 and 0.3%, values considered as maximal admissible concentrations.*

*Keywords : Liquid pig manure, lagoon storage, organic matter, nitrogen, phosphorus, copper, zinc, biopurification*

### Résumé

La filière de traitement comprend un tamis centrifuge, une décantation-biodégradation dans deux lagunes peu profondes et se termine par un épandage agricole. Le devenir des éléments polluants (carbone organique, azote, phosphore, zinc et cuivre) a été étudié au cours du processus de traitement. La capacité du tamis centrifuge est de 22.4 m<sup>3</sup>.h<sup>-1</sup> et permet l'enlèvement de 42.9 % de la matière sèche et 26,5% de la DCO, mais seulement 4,8% de N total et 9% de P, Cu et Zn. En ce qui concerne l'azote, 38.4 t an<sup>-1</sup> entrent dans la première lagune, puis 6.3 t décantent dans les sédiments et 7.6 t sont éliminées par volatilisation d'ammoniac et/ou nitrification-dénitrification ; la part respective de chaque mécanisme n'est pas définie. Les matières sèches des sédiments collectés dans la lagune contiennent, en moyenne, 3.3% de N et 5.5% de P. Cependant les teneurs en Cu et Zn sont supérieures aux concentrations maximales admissibles qui sont respectivement de 0.1 et 0.3%.

Mots-clés : lisier porc, stockage lagune, matière organique, azote, phosphore, cuivre, zinc, méthane, bio-traitement.

## 1. Introduction

Animal manures represent very large volumes of waste. They are traditionally used for landspreading in agriculture and provide important sources of organic matter and fertilisers. In France such manures represented in 1990 32.6 % of the nitrogen and 30 % of the phosphorus used in agriculture (IFEN, 1994-95). Pigs produce 116000 t of nitrogen and 51000 t of phosphorus annually (Théobald, 1997; from Leroy, 1994).

A slurry-treatment plant has been in operation for several years on a pig farm in the Dijon area. It is based on phase separation by centrifuge sieve and storage in shallow basins. The resulting slurry is then spread on the arable land on the farm.

An experimental nitrogen-treatment unit, consisting of a trickling filter on a gravel bed (Senez et al., 1997) and a denitrification reactor has been added to this system following laboratory studies (Boiran et al., 1996). Definition of the best way of integrating this experimental system into the other steps of the operation, necessitates a thorough understanding of the existing treatment system, especially of the changes occurring in the slurry in the shallow basin.

This study was therefore aimed to assess the current system and, more especially, to i) calculate the piggery effluent fluxes, ii) measure the efficiency of phase separation, and iii) determine the fate of the products during lagoon storage (sedimentation and biopurification). These assessments concern the organic matter or COD, nitrogen and phosphorus. The fate of other elements (K, Na, Cl, Cu and Zn) was also investigated.

## 2. Material and methods

### 2.1. The piggery and system of treatment

This pig farm is associated with large-scale arable cropping. There are three types of activities: breeding to obtain reproducers, piglet production and fattening of pork pigs. 7300 pork pigs are produced and 400 sows and boars are present throughout the year. The estimated effluent produced by the piggery is equivalent to that of a pig farm with an annual production of 10760 pork pigs.

Figure 1 shows the different stages of slurry treatment. The pigs are reared on a slatted floor. A 152 m<sup>3</sup> pit collects the manure and waste water and is emptied twice a week after forced recirculation of the slurry. A centrifuge sieve (Demoisy, 21200 Beaune) fitted with grid of 100 µm mesh retains a part of suspended particules ; the collected material is composted. The slurry moves by gravitational flow towards the lagoons which consist of two water-tight basins, each 3180 m<sup>2</sup> and 6000 m<sup>3</sup>, placed in series and allowing storage for more than six months. The slurry from the second basin is then spread on the soil by specially adapted sprinklers, if necessary after dilution. In summer when the liquid phase has been emptied, the sludge that has accumulated in the first lagoon is then removed for spreading.



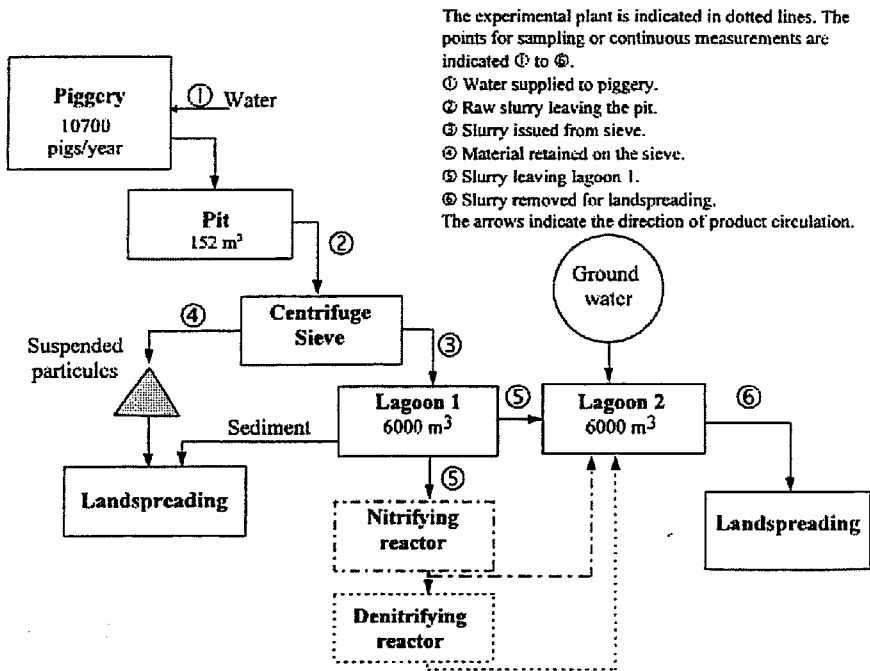

Figure 1  
Diagram of slurry treatment operations.

## 2.2. Measurements of liquid fluxes

The levels of dilution in the different parts of the system are determined by monitoring the concentrations of chloride tracers.

### 2.2.1. Slurry produced in the piggery and processed on the sieve

The water consumption is measured by meters and the amounts of slurry produced by the piggery calculated in two ways : i) from the sieving time and the mean flow rate at the sieve outlet, ii) from variations in the liquid volumes measured with limnimeters in the lagoons and after correction for rainfall. In both cases, the solid material refused by the sieve is taken into account.

Efficiency of the sieve separation was measured on four different days (13-2-96; 29-3-96; 28-6-96 and 25-3-97) from the mean flow-rates. These were calculated by measuring the volume variations in the collecting pit on the one hand, and the filling times of a calibrated container placed at the sieve outlet on the other hand, and by weighing the retained solid material. Weekly samples were taken of slurry from the collecting pit, after homogenisation, and of the slurry passing through the sieve.

### *2.2.2. Evolution of the slurry in the first lagoon*

The slurry entering the lagoon came directly from the sieve. The liquid flux across the first basin was evaluated as previously indicated. Samples of slurry were taken at the lagoon outlet at least once a week.

The measurements of flux were completed with two series of samples to determine the state of the first lagoon in winter and summer, on February 1<sup>st</sup> and July 25<sup>th</sup> 1996. The volumes of liquid and sediment were calculated using the Simpson formula (Saïac, 1989) from topographic readings at the bottom of the basin based on 55 points and measurement of the height of the liquid with a probe applying a pressure of 1000 Pa to the top of the sediment at 134 points.

### **2.3. Elements monitored and analysed**

The dry matter and total concentrations of the different elements were measured in the raw slurry samples, whereas the soluble elements and the suspended matter were determined after centrifugation (1000 G, 20 min). The COD was determined by AFNOR NF T 90 101 method, total nitrogen by the Kjeldahl method where necessary after nitrate reduction with iron. The mineral forms of nitrogen, orthophosphate and chloride were determined by colorimetric analyses in continuous flux (APHA, 1985). After mineralisation of the dry matter at 450°C and taking up the ash in acid medium the total phosphorus was determined by continuous flux analysis, the magnesium, copper and zinc by atomic absorption spectrometry, and the calcium, potassium and sodium by flame photometry.

## **3. Results and discussion**

### **3.1. Overall liquid and solid phase assessment**

#### *3.1.1. Feed input and slurry production*

Between March 1<sup>st</sup> 1996 and February 28<sup>th</sup> 1997, the piggery consumed 19000 m<sup>3</sup> of water and 2390 t of feed with a 12 % moisture content, which provided 65 t of nitrogen, 28 t of calcium and 16.8 t of phosphorus. The mean consumption of 52 m<sup>3</sup> of water per day was associated with a slurry production of 47 m<sup>3</sup> day<sup>-1</sup> (measured at the pit outlet) i.e. 1.6 m<sup>3</sup> of slurry per pig equivalent. This is a much higher value than the values of 0.7 to 0.8 m<sup>3</sup> habitually quoted in France. These slurries are highly diluted.

#### *3.1.2. Centrifuge sieve*

The mean flow-rate measured at the outlet of the centrifuge sieve on 4 different days was 22.4 m<sup>3</sup> h<sup>-1</sup>. The sieve retained 42.9 % dry matter and 47.9 % of the suspended matter in the refused solid with an initial moisture content of 75 %.

### 3.1.3. Lagoons

The liquid flux within the lagoon calculated from the volume variations measured throughout the year and corrected for precipitation was 17466 m<sup>3</sup>, which in view of the relative uncertainty of the measurements corresponded, more or less, to the volume of slurry (16475 m<sup>3</sup>) leaving the sieve.

Comparison of the loads at the inlet and outlet of the first basin showed that 248 t of dry matter per year could be retained by decantation and purification. The sludges deposited at the bottom of the basin had dry matter contents of 256 g.l<sup>-1</sup> in winter and 231 g.l<sup>-1</sup> in summer and were highly mineralised, with an average ash/dry matter ratio of 64 %.

In winter the separation between supernatant and decanted phase was clearly defined. On February 1st 1996 the first basin contained 4036 m<sup>3</sup> of liquid resting on 1463 m<sup>3</sup> of sediments. It was less obvious in summer. On July 25th 1996 this same basin contained 1228 m<sup>3</sup> of sediments and 3711 m<sup>3</sup> of supernatant liquid in which 2 strata could be distinguished. The first, to 50 cm in depth, was a highly decanted liquid whereas the second, between -50 cm and the sediment surface, was an intermediate zone with an increasing gradient of suspended matter corresponding to resuspension of the sediments.

## 3.2 Fate of the products in lagoon

### 3.2.1. Organic matter (COD)

The liquid manure leaving the piggery represents an annual effluent of 643 t of COD i.e. on average 59.7 kg COD per pig-equivalent, which is similar to the reference value of 58 kg per pig (Héduit, 1990). The centrifuge sieve holds back 28.1 % of this organic load i.e. 181 t COD.year<sup>-1</sup>.

Therefore the first lagoon received 462 t of COD for one year; assessment of the COD fluxes at the inlet and outlet revealed a reduction of 386 t during lagooning i.e. 83.5 % of the supplied amount. Between February 1<sup>st</sup> and July 25<sup>th</sup> 1996, the increased amount of organic matter in the first lagoon corresponded to a little more than half (53 %) of the difference in load between the input and the output, the other half (47 %) being considered as purified. If these ratios are applied to the entire year, the purified COD becomes 181 t, i.e. a yield of 57 kg COD.m<sup>-2</sup>. year<sup>-1</sup> or 156 g COD.m<sup>-2</sup>.day<sup>-1</sup>, corresponding to 58.5 g C.m<sup>-2</sup>.day<sup>-1</sup>.

In April 1977 we measured 62 g C.m<sup>-2</sup>.day<sup>-1</sup> released as biogas at the lagoon surface (70 % CH<sub>4</sub>-C, 30 % CO<sub>2</sub>-C). This data concurs with the previously estimated purifying capacity and confirms that methanisation is the principal mechanism of organic matter elimination. Application of this level of 70 % to 181 t of purified COD provides an estimate of 63 t of methane released over one year or 76 l.m<sup>-2</sup>.day<sup>-1</sup>. This is double the amount measured by Safley et al. (1989). These methane emissions are

certainly considerable but need to be evaluated over a longer period as methane production is highly dependent on temperature (Safley et al., 1989; Yang et al., 1997).

The amount of organic matter in solution removed for landspreading therefore represents no more than 11.8 % of the organic matter produced by the animals. A greater part was left in the compostable solid material that remained on the sieve (28.1 %) and in the sludges at the bottom of the basin (31.9 %) which are also destined for landspreading but require separate management (table 1).

	t.yr <sup>-1</sup>	% of effluent
annual piggery effluent	643	100.0
retained on the sieve	181	28.1
decanted in the lagoon	205	31.9
purified in the lagoon	181	28.1
removed for spreading	76	11.8

*Table 1  
Fate of the organic matter content (COD) during the treatment operations*

### 3.2.2. Nitrogen

The feeds supply 65 t of nitrogen per year. The nitrogen effluent estimated from measurements at the storage pit outlet was 40.6 t.year<sup>-1</sup>, that is 62.5 % of that supplied, with a low mean concentration in accordance with the diluted nature of the slurry : 2.4 g.l<sup>-1</sup> of total nitrogen with 1.3 g.l<sup>-1</sup> i.e. 54 % in ammoniacal form..

The centrifuge sieve retains little nitrogen: the concentration reduction of the liquid phase was only 2.9 % and when the liquid phase associated with the particles was taken into account, 4.8 % of the nitrogen, that is 2.2 t per year, were found to be retained in the material refused by the sieve, which, prior to composting, is therefore relatively poor in this element.

The nitrogen decanted in the sediments during the year was estimated using P, Cu and Zn as tracer elements : the amounts decanted were determined from the inputs and outputs of these elements, and the mean nitrogen ratios with each of them in the sediment to evaluate the amount of nitrogen retained (Senez et al., 1997): the values obtained varied between 5.3 t and 7.3 t depending on the tracer: the intermediate value of 6.3 t was retained. The difference between the previously indicated 13.9 t and the 6.3 t corresponds to the nitrogen that has been purified or volatilised, i.e. 7.6 t N. year<sup>-1</sup> or 6.55 g N. m<sup>-2</sup>.day<sup>-1</sup>.

A point estimate of the ammonia volatilised in April 1997 indicated 0.58 g.m<sup>-2</sup>.day<sup>-1</sup> of NH<sub>3</sub>-N. This value is low and should be compared with the volatilization values of 1.53 g NH<sub>3</sub>-N.m<sup>-2</sup>.day<sup>-1</sup>, measured by Schilton (1996) and 0.33 to 4.15 g NH<sub>3</sub>-N.m<sup>-2</sup>.day<sup>-1</sup> obtained by Sommer et al. (1996) over basins 20 to 200 cm in depth. In the present

case and in the absence of more numerous measurements, it was not possible to distinguish between the purified nitrogen and the volatilised nitrogen.

The collected data as a whole can be used to tabulate the measurements and estimates of the different transformations. It is apparent that the liquid phase taken from the lagoon and used for spreading only contains 53.8 % of the nitrogen excreted by the animals. When assessing the quantities applied to the land the 4.8 % i.e. the material that did not pass through the sieve and the 13.8 % i.e. the sludge decanted at the bottom of the basin, which require separate management, also need to be included (Table 2).

		t N.yr <sup>-1</sup>	% excreted N
1	nitrogen supplied in the feed*	65.0	
2	nitrogen retained by the animals (30 % of 1)**	19.5	
3	nitrogen excreted by the animals (1-2)**	45.5	100.0
4	nitrogen leaving the storage pit***	40.6	89.2
5	volatilisation under the animals (3-4)**	4.9	10.8
6	retained on the sieve ***	2.2	4.8
7	decanted in the lagoon**	6.3	13.8
8	purified or volatilised in the lagoon **	7.6	16.7
9	removed for landspreading***	24.5	53.8

\* estimated from farmer's data; \*\* estimated from ratios and calculations; \*\*\* estimated from measurements made during this study.

*Table 2  
Fate of the nitrogen content during the treatment operations*

### 3.2.3. Phosphorus

The phosphorus in the slurry is essentially in particulate form : the mean total P concentration at the pit outlet was 850 mg.l<sup>-1</sup> whereas the soluble fraction was only 55 mg.l<sup>-1</sup>, i.e. of the same order of magnitude as in the lagoon supernatant. In spite of this particulate character, little phosphorus (9.1 %) is retained by the centrifuge sieve, thus indicating its presence in the finest particles. Considerable decantation occurs in the lagoon, representing 90 % of the input and 82 % of the excreted phosphorus (Table 3). However the mean concentration in the sediments, 5.5 % of the dry matter, is indicative of the value of the decanted product as a fertiliser.

	t.yr <sup>-1</sup>	% of effluent
annual piggery output	14.2 t	
retained on the sieve	1.3 t	9.1%
decanted in the lagoon	11.6 t	81.7%
removed for land-spreading	1.3 t	9.1%

*Table 3  
Fate of the phosphorus content during the treatment operations.*

### 3.2.4. Other elements

The initial piggery effluent contains 15.5 t of potassium, 26.8 t of calcium, 4 t of magnesium and 3.9 t of sodium. The sodium and potassium do not undergo any transformation during their passage through the system and almost all can be found in the liquid to be used for land-spreading. The calcium and magnesium are decanted in the lagoon where their respective mean concentrations are 13.9 % and 2.3 % of the dry matter.

The concentrations of copper and zinc exhibit the same evolution as phosphorus during their passage through the system. Only 9 % of their mass is retained in the material refused by the centrifugal sieve. Most of these heavy metals, i.e. 82 % of the amounts excreted are decanted in the bassin and only 9 % are removed with the liquid phase for land-spreading. The copper and zinc contents of the sediments are higher than the maximal values admissible for urban sludge (1000 mg Cu.kg<sup>-1</sup> and 3000 mg Zn.kg<sup>-1</sup> on dry matter basis).

## 4. Acknowledgements

This work was financially supported by ADEME (Convention de Recherche 9575007) and by Conseil Régional de Bourgogne (Contrat de Recherche 96/5112/29/00012).

## 5. References

- APHA, 1985.** Standards methods for the examination of waste and wastewater. American Public Health Association, New York.
- Boiran M., Couton Y., Germon J.C., 1996.** Nitrification and denitrification of liquid lagoon piggery waste in a biofilm infiltration-percolation aerated system (BIPAS) reactor. *Biores. Technol.* 55, 63-77.
- Coillard J. 1997.** Procédés de traitements de lisiers de porcs étudiés en France. *Ingénieries EAT*, 10, 17-32.
- Couton Y., Boiran M., Devroe C., Senez L., Germon J.C., Lemièrre J.P., Coquille J.C., 1995.** Epuration de l'azote des lisiers de porcs par nitrification-dénitrification dans un procédé rustique d'épuration dérivé des lits bactériens. *Journées Rech. Porcine en France*, 27, 359-366.
- Hédouit, 1990.** Estimation de la part relative de chaque secteur d'activité dans l'atteinte à la qualité de l'eau. In *Production porcine et environnement*, ITP ed., Paris, 67p.
- IFEN, 1994-1995.** L'environnement en France. Dunod ed., Paris, 399p.

**ITP**, 1996. Le porc par les chiffres. Institut Technique du Porc ed., Paris, 40p.

**Oenema O., Roest C.W.J.**, 1998. Nitrogen and phosphorus losses from agriculture into surface waters; the effects of policies and measures in the netherlands. *Wat. Sci. Tech.*, 37, 19-30.

**Safley L.M., Westerman J., Westerman P.W.**, 1989. Anaerobic lagoon biogas recovery systems. *Biol. Wastes*, 27, 43-42.

**Saïac J.H.**, 1989. L'informatique appliquée au calcul scientifique. Dunod ed, Paris, 84-87.

**Senez L., Couton Y., Devroe C., Théobald O., Germon J.C.**, 1997. Bilan de fonctionnement d'une filière de traitement du lisier à la ferme intégrant un dispositif pilote d'élimination de l'azote. *Journées Rech. Porcine en France*. 29, 327-334.

**Shilton A.**, 1996. Ammonia volatilization from a piggery pond. *Wat. Sci. Tech.*, 33, 183-189.

**Siegenthaler A., Hani H., Stauffer W.**, 1998. Long term effects of excessive organic waste application. *Ramiran 98*, 8th international conference FAO network on recycling of agricultural, municipal and industrial residues. Rennes France 26-29 may 1998 (this volume).

**Sommer S.G., Sibbesen E., Nielsen T., Schoerring J.K., Olesen J.E.**, 1996. A passive flux for measuring ammonium volatilization from manure storages facilities. *J. Environ. Qual.*, 25, 241-247.

**Théobald O.**, 1997. Recyclage des éléments nutritifs issus de déchets et de sous produits en agriculture: perspectives et contraintes . ADEME, Angers, France, 8p.

**Yang P.Y., Kahn E., Gan G., Paquin D., Liang T.**, 1997. A prototype small swine waste treatment system for land limited and tropical application. *Wat. Sci. Tech.*, 35, 145-152.





# **Mineralflow : A model to determine cost efficient strategies to improve pig slurry application under de Dutch MINeral Accounting System**

*Minéral flux : un modèle destiné à déterminer les stratégies les plus efficaces et les moins onéreuses pour améliorer l'épandage de lisier de porc en regard de la nouvelle réglementation Hollandaise sur le système du bilan des minéraux.*

**drs. C.P.A. van Wagenberg and dr. ir. G.B.C. Backus**

Research Institute for Pig Husbandry, PO Box 83, 5240 AB Rosmalen.  
The Netherlands.

E-mail : C.P.A.VAN.WAGENBERG@pv.agro.nl

## **Abstract**

*A deterministic model (MINERALFLOW) was developed to determine the maximum economic performance of an individual pig farm. Decision variables were phosphorus (P) and nitrogen (N) content of the food, the feeding strategy, the slurry treatment system, the amount of slurry treated and the slurry application. MINERALFLOW was developed within the framework of the Dutch MINeral Accounting System (MINAS). At farm level the increase in feeding costs, due to a lower P content of the ration, and the decrease in slurry disposal costs have to be weighed. The decrease in slurry disposal costs depends primarily on the number of hectares own land and the intermediair slurry price.*

## **Résumé**

Un modèle déterministe MINERAL FLOW a été développé afin de déterminer les performances économiques optimum à l'échelle d'une exploitation porcine individuelle. Les variables étaient le phosphore (P), l'azote (N), contenus dans l'aliment, la stratégie d'alimentation, le système de traitement du lisier, la quantité de lisier traité et l'épandage de lisier. MINERAL FLOW a été développé dans le cadre de la nouvelle réglementation sur le bilan des minéraux (MINAS). A l'échelle de la ferme, l'augmentation du coût de l'aliment due à la diminution de la teneur en P dans la ration, et les diminutions du coût de gestion des lisiers doivent être prises en compte. La diminution du coût de gestion des lisiers dépend principalement du nombre d'hectares appartenant à l'éleveur et des coûts intermédiaires du lisier.

## **1. Introduction**

On January 1<sup>th</sup> 1998 a new environmental legislation, the MINeral Accounting System (MINAS), was brought into operation in the Netherlands. With MINAS the

Dutch Government tries to ensure a non excessive use of minerals on the land, thus reducing emission of ammonia and reducing wash out of nitrogen and phosphate. MINAS allows only limited losses of phosphate and nitrogen to individual farms. A loss is determined by a mineral account as the difference between the amount of P and N brought onto the farm and the amount of P and N brought of the farm.

As total space for mineral application tightens by MINAS regulations, pressure on the slurry market increases. This leads to increased prices for slurry and higher slurry costs for animal production farms, thus increasing the financial incentive for these farms to take measures. On farms with intensive animal production this will be noted first and most heavily. In the Netherlands pig farming is intensive. Tight regulations for arable farmers will reduce the application space for minerals even more. By improving the slurry quality the acceptance of slurry by arable farmers can be increased, thus reducing the pressure on the slurry market and decreasing slurry costs.

In this paper a model was presented which determined the optimal mineral strategy for individual intensive pig farms. The impact of differences between individual pig farms on the optimal mineral strategy was described. Furthermore the impact of different autonomic developments on the optimal strategy made by individual pig farms was described.

## **2. Method and materials**

### **Mathematical model**

MINERALFLOW was a deterministic mixed integer programming model. The model calculated results on the individual farm level and maximizes over the period of one year. Continuous decision variables (mineral content of the food, slurry application, the amount of slurry treated) as well as binary variables (feeding strategy, slurry treatment system) were used. All restrictions and the goal function were linear. The model was solved using the Branch and Bound method from the LP-procedure in the SAS package (SAS 1990).

Input variables were the number of pigs and performance of the farm, the number of hectares of land on which slurry can be applied, application time, other costs, type of housing (low emission or not) and the intermediair slurry price. The goal function maximized economic performance. The goal function was :

MAX economic performance =

revenues -/- (housing costs + pig costs + labour costs + health costs + heating costs + electricity costs + water costs + remaining costs) -/- feeding costs -/- slurry treatment costs -/- slurry costs

The decision variables had an impact on the feeding costs, slurry treatment costs and slurry costs. Labour costs, electricity costs and water costs concerning the feeding system and slurry treatment system were counted to the feeding and slurry treatment costs respectively. The other costs and revenues were assumed to be fixed.

The mineral composition of the slurry excreted by the animals was determined through simulation as the difference between the amount taken up with the food and the amount which was taken up by the animals. Slurry volume was determined depending on the amount of drinking and cleaning water.

## Mineral regulations

The application of minerals had to take place within the regulations of MINAS. In MINAS animal production farms with an animal intensity per hectare higher than a proposed standard had to apply a detailed mineral registration system. On these farms only a maximum loss of phosphate and nitrogen was allowed. On farms which had an actual loss that was higher than a standard loss, a levy was imposed. Farms with an animal intensity lower than the proposed standard (mostly arable farms) applied until 2002 only standards for supply of phosphate. From 2002 on for these farms also standards for phosphate and nitrogen losses were introduced. Until 2008 the regulations in MINAS tightened in phases (table 1) (Manure and fertilizing law 1997).

	1998	2000	2002	2005	2008
declaration on from animal intensity (gve <sup>3</sup> /ha)	2.5	2.5	2.0	2.0	2.0
standard for phosphate loss (kg P <sub>2</sub> O <sub>5</sub> /ha) <sup>1</sup>					
grasland, arable land and fallow	40	35	30	25	20
natural terrain	10	10	10	10	10
standard for nitrogen loss (kg N/ha) <sup>2</sup>					
grasland	300	275	250	200	180
arable land and fallow	175	150	125	110	100
natural terrain	50	50	50	50	50
standard for the supply of phosphate (kg P <sub>2</sub> O <sub>5</sub> /ha)					
grasland	120	85	80	80	80
arable land	100	85	80	80	80
fallow	40	35	30	30	30
natural terrain	20	20	20	20	20

<sup>1</sup> The levy on phosphate loss is 10.00 Dutch Guilders (Dfl) in 1998/1999 per kg phosphate per hectare. For the first 10 kg the levy is 2.50 Dfl. From the year 2000 on these levies are doubled to 20.00 Dfl and 5.00 Dfl respectively. From 2005 on the low levy on phosphate loss is only for the first 5 kg.

<sup>2</sup> The levy on nitrogen losses is 1.50 Dfl per kg nitrogen per hectare.

<sup>3</sup> gve is a standard for the number of animals. For example a fattening pig counts for 0.18 gve and a sow with piglets till 25 kg for 0.495 gve. 1 gve corresponds with 1 cow.

*Table 1*  
*Regulations in MINAS*

## Quality of slurry

In this paper, slurry quality was defined by both the ratio of P / N / potassium / organic matter in the slurry and this ratio compared to the ratio of the crop requirements for these components. The better the slurry composition was adjusted to the requirements, the better the slurry quality and the lower the slurry

(disposal) price. The price was determined by the difference between (1) the amount of N, K, and organic matter which maximal could be applied on the land (depending on the regulations) and (2) the amount of effective N, K and organic matter brought onto the land with the slurry by applying as much slurry as the phosphate standard allowed.

Slurry quality could be improved by changing the ratio between P, N, K, and organic matter. A pig farmer could realize this by changing the mineral content of the feed ration or by slurry treatment. Moreover, slurry treatment was used to lower the slurry transporting costs by removing water from the slurry. Most slurry treatments were based on separation of the slurry in a thin watery fraction and a thick fraction. The thin fraction could be used as a N-K fertilizer, the thick fraction as a P-organic matter fertilizer. The qualities of these two fractions were based on their fertilizing values.

### Quantitative assumptions within MINERALFLOW

In table 2, the defined situations at onset for farms with fatteners are presented. The farm situations varied with the number of pigs and performance.

	fav. <sup>1</sup> (1)	unfav.(2)	fav.(3)	unfav.(4)
-				
number of fattener places <sup>2</sup>	435	455	2690	2810
occupancy percentage %	92	88	93	89
daily gain g/day	750	700	760	710
feed conversion ratio kg/kg	2.70	2.90	2.50	2.80
water usage l/kg food	2.10	2.30	2.10	2.30
housing costs <sup>3</sup> Dfl/place	90	90	71	71
slurry treatment costs (centrifuge) Dfl/m <sup>3</sup>	5.95	5.95	5.95	5.95

<sup>1</sup> fav. = favourable performance, unfav. = unfavourable performance.

<sup>2</sup> The number of places is higher on farms with a lower occupancy percentage to reach an equal number of delivered pigs per year.

<sup>3</sup> Excluding slurry treatment, slurry storage outside the pig house, food storage and feeding system.

*Table 2*

### *Main quantitative assumptions within MINERALFLOW*

In the situations at onset the farms had 14.4 hectare of land (8 hectare gras, 3.4 hectare maize and 3 hectare sugar beets). The slurry that was not applied on own land, was sold to an intermediair at an intermediair slurry price of 15.00 Dfl per m<sup>3</sup>. The farms had a low emission pig barn and slurry was applied in spring. Application in autumn decreased the N effectiveness by 50%.

### 3. First results and discussion

#### Tightening regulations

Over time, regulations in MINAS tightened (table 1). It appeared that the phosphate regulations were strict for pig slurry. As a consequence of tightening regulations total application space for P on own land reduced resulting in a higher optimal value of the P content of the ration. In 1998 the calculated optimal P content of the ration was 4.92 g per kg food, in 2000 5.02 g per kg and eventually in 2005 5.12 g per kg. For the larger farm, optimal P content of the ration was the upper value defined, i.e. 5.12 g per kg. The economic performance decreased with 0.04 Dfl on the large farm and 0.30 Dfl on the small farm, each time the regulations tightened. At farm level total decrease in economic performance was almost equal for all four farms.

Due to tightening regulations less slurry could be applied on own land, thus increasing the amount of slurry which had to be sold to an intermediary against a higher price. This increased total slurry costs. A pig farmer had to find the optimal combination of feeding costs and slurry costs. In figure 1 an example is given for the farm with 400 fatteners and favourable performance. In this case the optimal strategy, i.e. the strategy with the minimal sum of feeding and slurry costs, was reached at a P content of the feed ration of 4.92 g per kg.

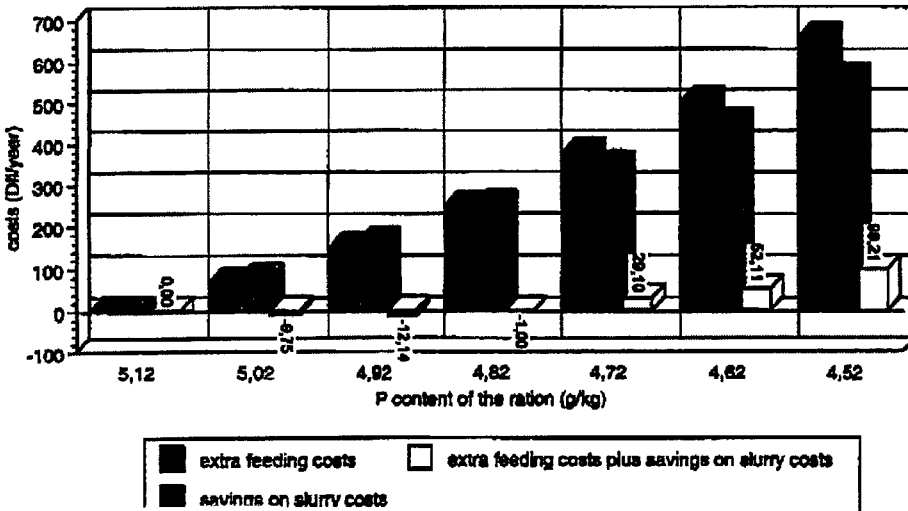

Figure 2

Extra feedings costs, savings on slurry costs and sum of feeding and slurry costs for 400 fatteners in relation to the P content of the ration.

### **Higher pressure on the slurry market**

A higher pressure on the slurry market resulted in higher slurry prices. As slurry prices increased from 15.00 Dfl to 45.00 Dfl, the optimal P content of the feed ration decreased from 4.92 with two phase feeding to 4.05 g/kg with multi phase feeding for the small farms and from 5.12 with two phase feeding to 4.37 g/kg with three phase feeding for the large farms. Three phase feeding was optimal for the large farm, because the additional investment costs could be spread over a large number of pigs. At very high slurry prices, 45.00 Dfl or higher, the optimal strategy for the large farm at onset was reducing the volume of slurry sold to an intermediary by slurry treatment. The thin fraction was applied on own land and the thick fraction was sold to an intermediary. The large farm treated as much slurry, until the total costs of treating 1 m<sup>3</sup> slurry, i.e. treatment costs, application costs of the thin fraction, including a levy, and the selling costs of the thick fraction, were higher than the slurry price.

### **Number of hectares**

The optimal mineral content of the feed ration depended on the amount of hectares own land (figure 2). Only in a small limited number of farm situations, the optimal P content of the ration was lower than the upper content defined in the model. Too little land implied that savings on the slurry costs were too small. The amount of additional slurry that could be spread on own land as the P content in the slurry was lower, was so small for a farm with little own land, that the savings on the slurry costs did not make up for the additional feeding costs. When a farm had enough own land to apply all the slurry, it was not necessary to reduce the level of P produced, because no savings could be made on slurry costs. The small farm had a lower optimal P content in the ration from around 12 to 22 hectares, depending on the performance. An unfavourable performance implied a high P production in the slurry and more own land needed to apply all slurry produced.

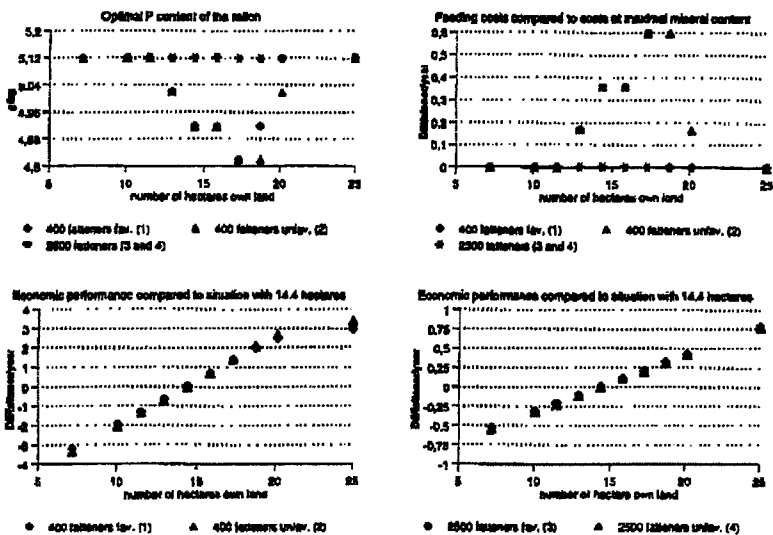

Figure 3  
Optimal P content, extra feeding costs and economic performance in relation to the number of hectares own land.

### Application on arable land with a quality approach

In table 3 the optimal mineral strategy and the slurry price are given when all slurry was applied on one type of crop in spring and in autumn for the farms in the situation at onset with favourable performance.

	Optimal P content				slurry price			
	400 fatteners		2500 fatteners		400 fatteners		2500 fatteners	
	spring	autumn	spring	autumn	spring	autumn	spring	autumn
intermediair	4.92	4.92	5.12	5.12	15.00	15.00	15.00	15.00
gras	5.12	4.82	5.12	4.77	8.49	11.10	8.36	10.98
maize	4.72	4.62	4.77	4.47	11.63	14.18	11.40	13.74
winter wheat	4.72	4.62	4.77	4.47	11.63	13.93	11.40	13.52
sugar beets	4.72	4.62	4.77	4.67	11.63	12.47	11.40	12.67
consumption potatoes	4.52	4.52	4.37	4.37	11.74	16.94	11.38	16.17
industrial potatoes	4.72	4.62	4.77	4.37	11.63	15.88	11.56	14.92
seed-potatoes	4.72	4.62	4.77	4.37	11.63	15.88	11.56	14.92
summer barley	4.72	4.72	4.77	4.77	11.63	11.63	11.40	11.40
seed-onions	4.62	4.52	4.77	4.37	12.86	14.06	12.93	13.28

Table 3  
Optimal P content of the ration (g/kg) and slurry price (Dfl/m<sup>3</sup>) by applying all slurry in spring or autumn on one type of crop for farms with a favourable performance

When slurry quality was taken into account, it appeared that only measures to reduce the P content of the ration were cost effective and measures to reduce the N content of the ration were not. Table 3 shows that the optimal P content of the ration when applying pig slurry to arable land, depending on the type of crop, application time and number of pigs, laid between 4.37 and 4.77 g/kg which was lower than the optimal P content when selling to an intermediair (4.92 to 5.12 g/kg). With application on grasland the optimal P content of the ration laid between these values. For the large farm three phase feeding was optimal with application on arable land, for the small farm two phase feeding on all possible applications.

The intermediair slurry price was fixed at 15.00 Dfl and assumed to be not depending of the slurry quality. The slurry price at application on arable land depended on the type of crop and laid in spring between 11.63 Dfl and 12.86 Dfl for the small farm and between 11.40 Dfl and 12.93 Dfl for the large farm. Application on arable land in autumn raised slurry prices due to the lower N effectiveness. Slurry prices varied in autumn between 11.63 Dfl and 16.94 Dfl for the small farm and between 11.40 Dfl and 16.17 Dfl for the large farm. The slurry price for grasland was about 3.00 Dfl lower than for arable land because application costs were about 3.00 Dfl lower. In general, except for application on seed-onions, the slurry price for the large farm was lower than for the small farm.

The optimal values of the small and large farm with unfavourable performance (situations 2 and 4) were comparable to those of the farms with favourable performance (situations 1 and 3 respectively). In general the optimal P content of the ration was lower and the optimal slurry price higher.

## **4. Conclusions**

**4.1.** With the above presented model of the slurry market and the MINAS legislation, it generally could be said that measures to reduce slurry costs were based on the P excretion. This meant in the first place that measures to reduce the P content of the ration were taken and measures to reduce the N content of the ration were not cost effective.

**4.2.** The amount of reduction of the P content of the ration primarily depended on the ratio of application space for P on own land and the amount of food used. A farm reduced the P content in the ration when the additional feeding costs were smaller than the reduction in slurry (disposal) costs. Slurry costs reduced as the P content of the slurry decreased and a larger volume could be spread on own land, at lower costs than selling to an intermediair. In general a lower P content in the ration was optimal when the total P production in the slurry was just lower than the total application space for P on own land.

**4.3.** A high pressure on the slurry market resulted in a high intermediair slurry price, which led to more incentives to take measures to reduce the amount of P excreted in the slurry by reducing the P content of the feed used or changing to



three or multi phase feeding. A higher level of the intermediary slurry price resulted in a lower optimal P content of the ration.

**4.4.** When slurry quality was taken into account, the optimal P content of the ration when applying pig slurry to arable land was lower than when selling to an intermediary, without slurry quality. Application on grass land implied an optimal P content of the ration in between these values. As the N effectiveness decreased the slurry price increased. Also the optimal P content of the feed was lower when the N effectiveness was lower.

## **5. Literature**

Manure and fertilizing law 1997. *Amendement manure and fertilizing law.* (In Dutch) Staatsblad van het Koninkrijk der Nederlanden, volume 1997, nr. 360.

SAS Institute Inc. 1990. *SAS User's Guide.* Version 6, fourth edition.

Wagenberg, van C.P.A. and G.B.C. Backus 1998. *Model MINERALFLOW.* Research Report (In Dutch) to be published, Research Institute for Pig Husbandry, Rosmalen.



# Effects of an enzymatic additive on ammonia concentration on a broiler farm.

*Effets d'un additif enzymatique sur les concentrations en ammoniac dans un bâtiment de volailles de chair.*

**G.Bonazzi, C.Fabbri, L.Valli.**

Centro Ricerche Produzioni Animali.

Via Crispi 3. Corso Garibaldi 42. 42100 Reggio Emilia. Italy.

E-mail : G.Bonazzi@crpa.it

## Abstract

*Various chemical-biological additives, designed to reduce emissions of harmful gases in poultry housing, are increasingly available on the market. This paper reports a monitoring operation set up to verify the suitability of one of these additives in a broiler production facility. The trial was conducted in a single facility by comparing one building treated with one of the above-mentioned additives with another untreated building. The comparative study was based on detecting the concentration of ammonia at a height of 1.6 metres along the ventilation axis of the building. The monitoring operation lasted for 17 days of the production cycle, for a total of 68 samples/building. With analogous environmental conditions, the ammonia concentration detected was 53% higher in the untreated building.*

## Résumé

Divers additifs chimiques et biologiques, destinés à réduire les émissions de gaz indésirables en bâtiments d'élevages avicoles, sont de plus en plus répandus sur le marché. Cet article rapporte un travail d'évaluation de l'efficacité de l'un de ces additifs testé dans un bâtiment de poulets de chair. L'essai a été mené sur un bâtiment traité avec l'additif en comparaison avec un bâtiment analogue témoin. L'étude comparative a porté sur la concentration en  $\text{NH}_3$  à une hauteur de 1.6 m le long de l'axe de ventilation du bâtiment. La période de suivi de 17 jours au cours du cycle de production a permis de prélever 68 échantillons / bâtiment. Avec des conditions environnementales similaires, les concentrations en  $\text{NH}_3$  détectées étaient supérieures de 53% dans le bâtiment témoin.

## 1. Introduction

To reduce the concentration of harmful gasses inside the broilers housing, the most widespread technology used is that of correct ventilation assisted by a suitable system of control and regulation that makes it possible to achieve the best results while reducing animal discomfort to the minimum.

As an auxiliary aid to the ventilation systems, a number of additives are available on the market that can help to reduce the emission of harmful gasses inside the housing (1, 2). This monitoring project was designed to verify the suitability of one of these products on a broiler farm.

The additive in question is a polyenzymatic compound of biological origin designed for the treatment of organic substances for the purposes of deodorization, metabolization, and humification. The composition of the product is shown in Table 1. It is claimed to synergize and strengthen the action of the indigenous microbiotic flora useful for the transformation of the organic substance into stabilized compounds, without bringing in new species. Ammonia emissions would be limited as a result of nitrogen fixation into proteic compounds.

<i>Lithothamnium calcareum algae</i>	40%
<i>Refermented lavic crushed stone and dolomites</i>	20%
<i>Culture based on vegetal lecithin and organic substrata from fermentation</i>	20%
<i>Macroelements (N-P-K-Ca-Mg) of vegetal origin</i>	7%
<i>Microelements of vegetal origin</i>	3%
<i>Humic acids</i>	3%
<i>Enzymes: amylase, cellulase, lactase, lipase, pancrease, protease, phosphorylase, invertase</i>	2%
<i>Nucleic acids</i>	trace
<i>Low-release organic nitrogen and excipients</i>	to 100

**Table 1**  
*Average composition of the additive*

During the course of 1996-97, two monitoring cycles were carried out on the ammonia concentration of two housings on a broiler farm: the first was treated with the additive in the measure of 2 kg per 1000 m<sup>2</sup> as of the 24th day of age of the broilers; the second was not treated.

## 2. Materials and methods

The comparison between treated and untreated housing was made measuring the ammonia concentration at 1.6 m of height at the centre of the transverse section along the axis of ventilation. The housings are made of prefabricated reinforced concrete of 16 x 150 m (2400 m<sup>2</sup>) each with a total capacity for 29,000 heads (0.083 m<sup>2</sup>/head). The air exchange is obtained by means of a series of 12 axial extractors of 1200 mm diameter situated along the longitudinal side of the housing at a distance of approximately 12.5 metres between them. The air enters from a series of windows that can be regulated in height, which are situated along the entire opposite longitudinal side. This system creates air circulation that is transverse with respect to the axis of the housing. The ventilation is controlled by varying the rotation speed of the fans with 5 speeds based on the information supplied by a pair of temperature probe positioned along the longitudinal axis of the housing.

The flooring is in solid reinforced concrete and covered at the moment of entry of the broilers with a layer of about 5 cm of chopped straw. This operation requires nine 300 kg round bales, approximately 1.1 kg m<sup>2</sup>. Feed produced in the farm mill is used, distributed *ad libitum* during the first 22 days, with a starting mixture containing 23.3% raw protein and 3.1 Mcal/kg of metabolizable energy and, from the 22nd to the 55th day of the cycle, with a mixture containing 21.4% raw protein and 3.2 Mcal/kg of metabolizable energy.

The broilers are admitted with a difference of one day between one housing and the other. During the initial period, the temperature is maintained at 26°C and reduced by 1.5° per week.

The raising cycle lasts for a total of 55 days. At the 40-45th day, the hens (about 30-35% of the head present) are taken away, and the roosters are left to occupy the entire housing. Broiler hens of an average of 1.7 kg/head, and roosters of 2.6-2.7 kg/head are produced, with an average mortality rate of 2.5-3% and a feed conversion index of 0.49 kg of meat/kg of feed. Table 2 summarizes the production parameters of the two cycles. At the end of the cycle, the litter is accumulated at the centre of the housing and transported to a nearby compost and pelletizing centre. The average production is 37 t of litter as is with 23-30% moisture, equivalent to 1.3-1.4 kg/head. Considering 5 fattening cycles, the annual production is about 6.5-7 kg/broiler place-year.

Cycle	Period	No.Head			Meat production [t]	Feeding [t]
		Inlet [n°]	Outlet [n°]	Death-rate [%]		
1st cycle - treated - untreated	autumn	27500	26472	3.7	65.1	130.2
		29000	28205	2.7	70.5	141.0
2nd cycle - treated - untreated	summer	28600	25969	9.2	61.1	126.0
		30050	27884	7.2	64.5	133.1

Table 2  
Animal performance

The following environmental parameters were recorded :

- outside temperature,
- inside temperature,
- inside relative humidity,
- litter temperature,
- ventilation rate (as a percentage of the maximum value),
- ammonia concentration.

Two portable dataloggers were used for the environmental parameters, and two programmable sequential samplers equipped with 8-input solenoid valve unit were used for measuring ammonia concentration. The samplers were programmed to

take air samples at the centre of a section of the housing for 3-6 consecutive hours. The air flow thus measured was scrubbed in a 1% sulphuric acid solution.

During the first production cycle, a total of 9 days were monitored, divided into three sequences of three days each (144 samples total); in the second, 15 days were monitored, with sequential samplings of 6 hours each (120 samples total).

The litter at the end of the cycle was weighed, sampled, and analyzed.

### 3. Results

Table 3 shows the average environmental parameters and ammonia concentration measured during the course of the monitoring period, and Figures 1 and 2 show the respective trends. The ammonia concentration measured during the first cycle monitored was higher in the untreated housing by 46%: 29.4 mg/m<sup>3</sup> (42 ppm) for this housing against 15.8 mg/m<sup>3</sup> (22.6 ppm) for the treated housing. Analogously, during the second experimental cycle, the ammonia concentration of the untreated housing was higher by 58%: 18.6 mg/m<sup>3</sup> (26.6 ppm) for the control housing against 7.6 mg/m<sup>3</sup> (11.1 ppm) for the treated housing.

Cycle	Temperature				Inside relative humidity [%]	Ventilation rate (1) [%]	Ammonia concentration [mg/m <sup>3</sup> ]
	Outside	Inside	Litter	Out-In			
	[°C]	[°C]	[°C]	[°C]			
<i>1st cycle</i>							
- treated	14.7	19.6	24.0	4.9	77.8	n.d.	15.80
- untreated	14.7	20.4	24.1	5.9	75.5	d.d.	29.4
<i>2nd cycle</i>							
- treated	17.3	21.7	26.5	4.5	74.8	52.7	7.6
- untreated	17.3	23.4	28.2	6.1	79.0	52.5	18.6

Note: (1) ventilation rate is expressed as percentage of maximum fan speed

Table 3  
Average ambient data and ammonia concentration during monitoring periods

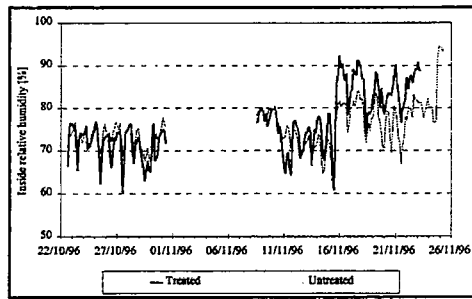
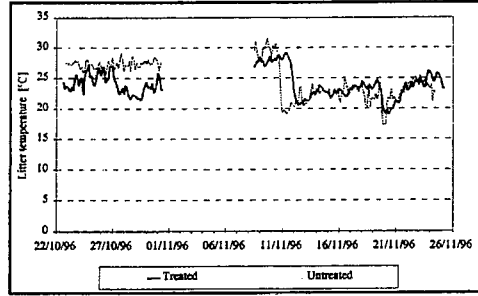
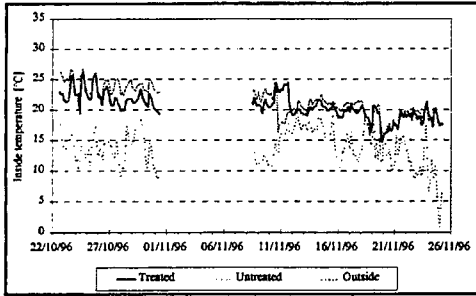

**Figure 1**  
*Monitoring data trend during first experimental period: outside, inside and litter temperature and inside relative humidity.*

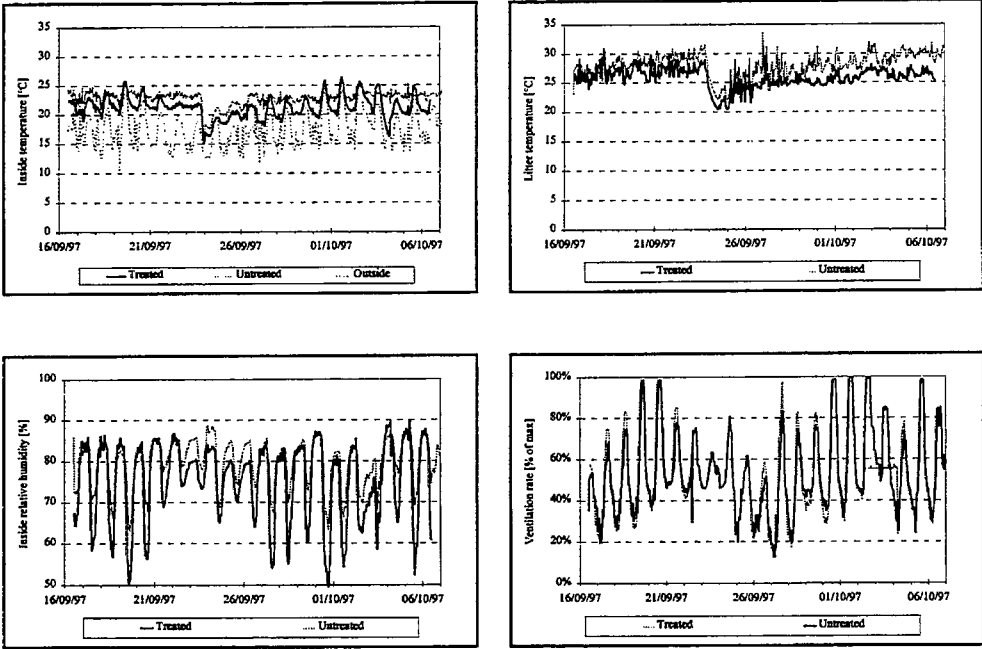
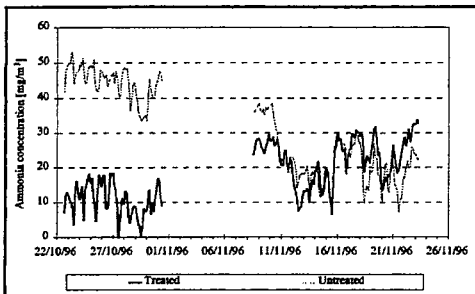

**Figure 2**  
**Monitoring data trend during second experimental period: outside, inside and litter temperature, inside relative humidity and ventilation rate.**

To eliminate the environmental differences of the two housings, the values found were submitted to statistical analysis and the linear interpolation function was identified on the basis of the parameters of outside temperature, inside temperature, litter, relative humidity, live weight present, and ventilation (the latter parameter was used only for the second cycle).

Figure 3 shows the values of ammonia concentration recalculated on the basis of identical environmental conditions. In this case, the average concentration calculated resulted as: 30.4 mg/m<sup>3</sup> for the control housing, and 16.8 mg/m<sup>3</sup> for the treated housing, with an average reduction of 45% for the first cycle, and 21 mg/m<sup>3</sup> and 5.6 mg/m<sup>3</sup>, for the second cycle, with an average reduction of 73%. The difference found in the second cycle between the values of ammonia concentration reduction is due to the different inside temperature conditions of the housings and the litter.





*First cycle : low outside temperature and minimum ventilation rate during starting cycle induced high ammonia concentration in untreated house. During this phase it has been monitored significative additive effect.*

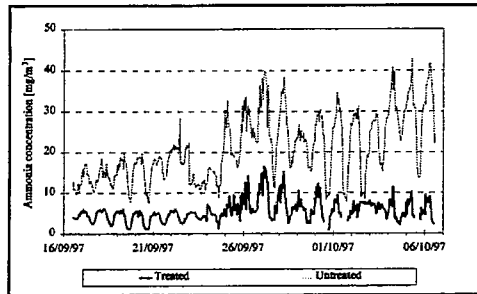

*Second cycle : late summer temperature and high ventilation rate induced low ammonia concentration in both broilers houses. It has been monitored high additive effect also in this period.*

**Figure 3**

*Inside ammonia concentration ( $\text{mg}/\text{m}^3$ ) trend during monitoring periods. Graphs reports elaborated data: multiple linear regression based on temperature (inside and outside), live weight, relative humidity and ventilation rate (only for second period).*

The characteristics of the outgoing litter of the housings (Tables 4 and 5) lead to a number of observations :

- the moisture level of the product is only affected by the treatment in a limited way: 31.5% in the treated housing against 28.2% in the control housing during the first cycle, and 20% vs. 28%, respectively, in the second cycle;
- a higher quantity of nitrogen remains in the treated litter with respect to the untreated litter, 37,600 vs. 37,060 mg/kg for the first cycle, and 48,280 vs. 39,730 mg/kg in the second cycle. In quantitative terms, this is equivalent to 1480 vs. 1409 kg nitrogen content in the first cycle, and 1777 vs. 1557 kg in the second cycle;
- the different quantity of nitrogen that remained bound to the organic substance is clearly shown by the C/N ratio: the analysis showed that it was significantly lower in the treated litter with respect to the control litter: 8.46 vs. 9.56 in the first cycle, and 7.34 vs. 7.6 in the second cycle;
- considering the quantities of nitrogen administered with the feed and those excreted, some evaluations were made regarding the ammonia emissions of the housing: for the control housing, an estimate of 0.30 kg/head/year was made, and 0.24 kg/head/year for the treated housing, with an average reduction of 20%;
- the differences in ammonia emission between the two cycles (-15% for the first and -25% for the second) are in line with the different level of the ammonia concentration reduction found inside the housings, though it was not possible to indicate an exact correspondence.

Parameters		Untreated litter		Treated litter	
		1st cycle	2nd cycle	1st cycle	2nd cycle
pH		8.48	9.18	8.74	8.26
TS	[g/kg]	718.59	719.12	685.43	799.66
VS	[g/kg]	601.8	587.13	569.1	674.02
	[% TS]	83.74	81.65	83.02	84.29
NTK	[mg/kg w.b.]	37060	39730	37600	48280
	[% TS]	5.16	5.52	5.49	6.04
N-NH4	[mg/kg w.b.]	4860	5320	4530	3250
	[% NTK]	13.11	13.39	12.05	6.73
TOC	[% ST]	49.3	41.97	46.06	44.33
C/N		9.56	7.60	8.46	7.34

**Table 4**  
*Litter composition at the end of the cycles*

Parameters		Untreated litter		Treated litter	
		1st cycle	2nd cycle	1st cycle	2nd cycle
N intake	[kg] (1)	4906	4630	4530	4383
N excretion	[kg]	2876	2772	2656	2624
	[kg/head.y] (2)	0.52	0.53	0.53	0.52
Litter	[t]	38.0	39.2	39.4	36.8
	[kg/head.cycle]	1.35	1.41	1.49	1.42
	[SS %]	71.91	71.86	79.97	68.54
N into litter	[kg]	1409	1557	1480	1777
Housing N emission	[kg]	1467	1215	1176	847
	[kg/head.y] (2)	0.27	0.23	0.23	0.17

Note: (1) average protein content: 21,7%; (2) based on 5 cycles/year

**Table 5**  
*Nitrogen balance*

## 4. Discussion and conclusions

The inside temperatures were lower on average in the treated housing than those in the untreated housing, with more accentuated differences in the late summer cycle (2nd cycle) with respect to the autumn cycle (1st cycle). Analogous temperature differences were found on the surface of the litter, with higher average values in the litter of the untreated housing (+1.7 °C in the late summer cycle). Only in the first cycle (autumn) did the difference diminish and then disappear completely in the final phases (Fig. 1).

The trend of nitrogen concentration in the litter clearly reflects the thermal trend of the litter. Nitrogen concentration was always higher in the untreated housing in the presence of higher temperatures of the litter, while the difference in concentration between the treated and untreated housing tended to disappear as the temperature differences between the litters disappeared (Fig. 1).

The reasons for the untreated litter having a higher temperature than the treated litter are not easy to interpret. The effectiveness of the product used to reduce

ammonia emission is confirmed by the data resulting from the chemical analysis made on the outgoing litter (Table 4), which show higher quantities of nitrogen in the treated situation. An attempt to balance the nitrogen which accounts for the amount ingested by the animals, that which is excreted and that which is found in the litter, makes it possible to estimate the ammonia emission and to confirm, also by this means, an appreciable effectiveness of the additive used.

Given the limited number of trials, this result cannot yet be considered conclusive. Nonetheless, further testing would be in order and, if further confirmation is found, the research should be developed in order to better understand the mechanisms that govern the action of this and other biological additives currently on the market.

## **5. References**

1 - **Hendriks J., Berckmans D., Vinckier C., 1997** - Field tests of bio-additives to reduce ammonia emission from pig houses. Proceedings of the International Symposium, Vinkelord, The Netherlands, October 6-10.

2 - **Martinez J., Jolivet J., Guiziou F., Langeoire G., 1997** - Ammonia emissions from pig slurries: evaluation of acidification and the use of additives in reducing losses. Proceedings of the International Symposium, Vinkelord, The Netherlands, October 6-10 1997. Voermans J.A.M. and Monteny G. (eds), Vinkelord, NLD, 485-492.



## **Comparison of the survival of *Salmonella Typhimurium* in the solid fraction from agricultural wastewater treatment plant in summer and winter seasons.**

*Comparaison de la survie de Salmonella typhimurium dans la fraction solide d'effluents d'élevage issus d'un traitement, en été et en hiver.*

**Venglovský, J., Plachá, I.,  
Sasáková, N.,**  
Research Institute of Experimental Veterinary  
Medicine, Hlinkova 1/A, 040 01 Košice,  
Slovak Republic  
Tel. 421 95 6331852. Fax. 421 95 6331853  
E-mail : venglov@tuke.sk

**Para, L**  
University of Veterinary Medicine,  
Komenského 73, 040 01 Košice,  
Slovak Republic

### **Abstract**

*Observations of survival of Salmonella typhimurium in the solid fraction from agricultural wastewater treatment plant was carried out in summer and winter seasons. The Salmonella typhimurium microorganisms tested survived for 26 days in summer and 88 days in winter. In the course of the experiment they decreased by one to two orders of magnitude with the exception of fecal coliform microorganisms which exhibited increase by one order on day 5 of the experiment and subsequent decrease to the original count by day 48 of the experiment. The plate counts of indicator microorganisms in winter were in the range from  $10^2$  to  $10^8$  CFU/g of the sample. In the course of the experiment they decreased by one to three orders.*

### **Résumé**

Les observations sur la survie de *Salmonella typhimurium* dans la fraction solide d'effluents d'élevage issus d'un traitement, ont été réalisées en période estivale et hivernale. Les bactéries *Salmonella typhimurium* testées ont survécé pendant 26 jours en été et 88 jours en hiver.

Les comptages de microorganismes indicateurs en hiver se situaient de  $10^2$  à  $10^8$  UFC / g d'échantillon. Au cours de l'essai, ces microorganismes décroissent d'un facteur 1 à 3.

## 1. Introduction

The occurrence of pathogenic and potentially pathogenic bacteria in an ecosystem is associated mainly with animal production. Especially the farms with literless technology, producing excrements in a liquid form, pose a serious threat in view of the absence of biothermic reaction in the liquid medium, the process which is responsible for devitalization of pathogens in the solid animal manure. An important factor is the high initial count of coliform, mesophilic and psychophilic germs. Of them, for example *salmonellae* have almost ideal conditions in the slurry for their survival.

One of the possibilities how to overcome the problems mentioned are wastewater treatment plants operating at animal farms. They use technology which starts with separation of the solid fraction of slurry on vibrating screens or press belts. The solid fraction of slurry is transported to field heaps or landfills and can be a source of spreading of many pathogens. It is necessary to realize that animal excrements are the biggest source of organic substances that should be returned to soil. This problem was discussed by J u r i š et al. (1993), N o v á k et al. (1994) who arrived to the conclusion that the most suitable way of processing of the solid fraction is its composting by means of biothermic processes that reach thermophilic temperature range which can guarantee devitalization of pathogenic microorganisms. Despite the recommendations mentioned, insufficient attention is paid to manipulation with the solid fraction of slurry. For this reason we investigated the survival of indicator and tested microorganisms (*Salmonella typhimurium*) in the course of storage of the solid fraction. With regard to the fact that the temperature is one of the most important factors affecting the survival of microorganisms, we carried out investigations of above mentioned parameters in summer and winter seasons.

## 2. Material and methods

The solid fraction of slurry was obtained from wastewater treatment plant operating at pig farm in Košická Polianka and stored in a 50 l container. The temperature of the environment and inside the substrate was recorded with a programmable registration thermometer (Commeter) made by COMET System, Roznov p. R., Czech Republic, in 1 hour intervals.

A lyophilised *Salmonella typhimurium* strain SK 14/39 (State Health Institute, Prague) was used as a test strain. The revitalized culture was inoculated to leather squares (4 x 4 cm) and directly to the solid fraction which was transferred to PVC bottles provided with side openings to ensure contact with the environment. Dried-up leather pieces were incubated in a thermostat for 24 h at 37°C to achieve good adhesion of salmonellae to the carriers. Both types of carriers were transferred to the container with the solid fraction and were examined in time intervals specified in Tab. 3 and 6 by the method according to M ü l l e r (1973). By means of sterile equipment we transferred the carriers to a sterile 0,9% saline physiological solution

and after 30 min of shaking and 30 min of sedimentation we prepared decimal dilutions up to  $10^{-10}$ . The dilutions were inoculated to XLD and SS agar (Imuna) and incubated for 48 h at  $37^{\circ}\text{C}$ .

At the same time, we examined the carriers qualitatively for the presence of salmonellae using nutrient broth No. 2 (Imuna) for non-selective pre-enrichment and selenite (Imuna) and Rappaport and Vassiliadis media (Merck, Darmstadt) for selective cultivation.

After the incubation, we transferred the colonies to XLD and SS agar (Imuna) and incubated for 48 h at  $37^{\circ}\text{C}$ . Suspected colonies were examined serologically and biochemically.

A glass vial with No. 2 broth, inoculated with the revitalised culture of *Salmonella typhimurium*, was used as a control. Each sampling consisted of examination of 3 carriers and 3 control vials.

At the beginning of the experiment, we examined the solid fraction for the presence of *Salmonella* spp. by cultivation on XLD and SS agar following the previous pre-enrichment in the broth and selective cultivation on Rappaport-Vassiliadis medium (Merck).

The samples of solid fraction (50 g) intended for determination of dynamics of indicator microorganisms and chemical examinations were taken as average samples in time intervals specified in Tab 1 and 3. The examinations of dynamics of indicator microorganisms were carried out according to CSN 83 0531 and included determinations of numbers of psychrophilic, mesophilic, fecal coliform and coliform microorganisms and fecal streptococci. Samples were diluted in 0,9% saline solution up to concentrations  $10^{-6}$ . The quantitative determinations of psychrophilic and mesophilic microorganisms were carried out on nutrient agar No. 2 (Imuna), of fecal coliform and coliform on Endo agar (Imuna) and of fecal streptococci on the selective agar for isolation of fecal streptococci (Imuna).

The examination of physical-chemical parameters, pH, dry matter, ammonia nitrogen and total nitrogen were carried out according to CSN 83 0540 and those of total phosphorus according to the standard methods APHA (1985).

### 3. Results

At the beginning of the experiment carried out in the summer season (june-august), the numbers of indicator microorganisms in the solid fraction of pig slurry ranged from  $10^3$  to  $10^7$  CFU/g sample. The most marked decrease by two orders was observed in psychrophilic microorganisms while the coliform and mesophilic germs decreased by one order only. Fecal coliform microorganisms and fecal streptococci exhibited no changes except for an increase by one order on days 5 and 26 and subsequent decrease to the original value on day 48 for the fecal coliforms. Fecal

streptococci exhibited the same values throughout the experiment with the exception of day 26 when a decrease by one order was observed followed by subsequent increase to the original value (Tab 1).

days	mesophilous CFU/1g	coliforms CFU/1g	psychrophilous CFU/1g	faecal coliforms CFU/1g	faecal streptococci CFU/1g
0.	3,38E+07	6,92E+05	6,67E+07	9,35E+04	2,37E+04
5.	1,64E+07	6,20E+06	4,88E+05	9,76E+05	1,93E+04
26.	1,57E+06	4,52E+06	2,18E+07	8,51E+05	4,63E+03
48.	3,12E+06	6,11E+04	2,71E+05	8,53E+04	5,00E+04
60.	2,01E+06	3,02E+04	3,51E+05	7,02E+04	3,01E+04

Table 1  
Dynamics of indicator microorganisms in solid fraction - summer.

The *Salmonella typhimurium* microorganisms tested in this summer season were recovered the longest from the PVC carrier, namely for 26 days, when a change of pH from alkaline to acidic value (from 8,08 to 6,5 – Tab 2) was also recorded. The number of *Salmonella typhimurium* microorganisms in the control glass vial remained the same.

days	pH	dry mater (%)	N-total (g/kg)	N-NH <sub>4</sub> (g/kg)	organic matter(%)	inorganic matter(%)	P-total (g/kg)
0.	8,08	21,37	39,56	0,78	93,2	6,8	1 223,50
5.	7,28	20,02	42,99	0,84	92,74	7,26	1 218,60
26.	6,5	20,66	20,2	0,54	91,8	8,2	1 192,30
48.	5,75	14,96	28,21	0,48	90,88	9,12	934,2
60.	5,8	13,81	31,2	0,52	88,02	10,01	980,9

Table 2  
Physico-chemical parameters - summer

The physical-chemical examinations showed marked decrease in pH from the initial value of 8,08 to the final value of 5,80. The values of N-NH<sub>4</sub> showed a decrease with the exception of day 5 of the experiment when a slight increase with regard to initial value was detected. Other values exhibited slight decrease with the exception of inorganic substances the values of which were on slight increase (Tab 2).

The external temperature ranged from 10 to 33°C and that inside the solid fraction from 17 to 26°C.

The numbers of indicator microorganisms in the solid fraction in winter season (january-june) ranged from 10<sup>2</sup> to 10<sup>8</sup> CFU /g sample. During the storage the numbers of psychrophilic and mesophilic microorganisms decreased by one order. The numbers of fecal streptococci and fecal coliforms decreased by two orders and the numbers of coliform microorganisms by one order on day 54 of the experiment, however, the latter increased to the original number by day 120 (Tab 3).



days	mesophilous CFU/1g	coliforms CFU/1g	psychrophilous CFU/1g	faecal coliforms CFU/1g	faecal streptococci CFU/1g
0.	3,01E+07	3,48E+05	2,59E+07	5,32E+05	1,38E+05
4.	5,37E+07	1,58E+05	2,80E+08	7,04E+04	1,80E+05
40.	4,21E+06	2,31E+05	1,87E+08	3,51E+04	1,49E+04
54.	1,73E+05	5,03E+04	7,12E+07	1,29E+04	3,72E+04
76.	6,50E+06	2,55E+04	3,44E+07	1,69E+04	1,50E+04
85.	9,17E+06	3,90E+04	9,64E+06	1,23E+04	2,93E+04
120.	6,32E+05	5,05E+05	9,00E+06	3,00E+02	7,30E+03
137.	3,03E+06	5,19E+05	6,41E+06	5,15E+03	6,85E+03

**Tableau 3**  
*Dynamics of indicator microorganisms in solid fraction - winter*

The *Salmonella typhimurium* microorganisms tested were recovered qualitatively on day 85 from both carriers. Quantitative determination allowed us to recover them up to day 4 on the leather carrier and up to day 54 on the PVC carrier. The number of microorganisms in the glass vial remained the same.

days	pH	dry matter (%)	N-total (g/kg)	N-NH4 (g/kg)	organic matter(%)	anorganic matter(%)	P-total (g/kg)
0.	8,52	16,06	3,49	1,37	91,07	8,93	1 680,22
4.	8,14	15,95	3,67	0,99	89,33	10,67	2 088,22
40.	8,26	13,09	4,54	1,12	89,47	10,53	1 274,66
54.	8,6	15,484	4,97	0,7	91,66	8,34	1 157,89
76.	8,31	15,55	4,11	0,84	89,44	10,56	1 202,11
85.	8,1	15,138	4,41	0,91	87,71	12,29	1 062,67
120.	7,01	15,089	4,75	0,94	87,91	12,09	2 012,42
137.	7,28	16,68	4,49	0,49	88,88	11,12	1 876,32

**Tableau 4**  
*Physico-chemical parameters - winter*

The physical-chemical examination showed 3-fold decrease in ammonia nitrogen in comparison with the initial value. The values of total nitrogen, inorganic substances and total phosphorus showed slightly increasing trend. The value of pH decreased from 8,52 to 7,28 and the values of organic substances also exhibited slight decrease. The dry matter content decreased up to day 40 after which it increased to the original value (Tab 4).

The external temperature in this season ranged from -11 to 48°C and that in the solid fraction from -1 to 30°C.

## 4. Discussion

The results obtained indicate that the temperature has a pronounced effect on the survival of *Salmonella typhimurium* germs. Our results point to the differences in the survival of salmonellae in the summer (26 days) and winter (85 days) periods

which is in an agreement with the data of many authors (D e a n, 1981; S t r a u c h, 1991; A h m e d, 1995 and others) that the temperature is a significant factor of survival of salmonellae. M ü l l e r (1973) stated that the viability of various salmonella species in slurry ranges from 4 to 97 days in summer and up to 87 days in winter which is comparable with results obtained in our study.

In addition to the temperature the dry matter content also affects significantly the survival of salmonellae. M i t c h e r l i c h and M a r t h (1984) compared the survival of *Salmonella typhimurium* in three types of manure with different content of dry matter and arrived to the conclusion that the *S.typhimurium* germs survived for 84 days at 10°C in the manure with dry matter content of 17,3% which is the value comparable with the dry matter content in the solid fraction used in our experiment (Tab 4). The results of authors mentioned above resemble our observations of survival of *S.typhimurium* for 85 days.

S t r a u c h (1991) stated that salmonellae survive the longest at dry matter content above 5% and temperature below 10°C which is in agreement with the results of our experiment in which, in the summer season at higher content of dry matter (Tab 2) and higher temperature, *S.typhimurium* germs survived for shorter period of time (26 days) in comparison with the winter season when the temperatures and the dry matter content were lower (Tab 4) and *S.typhimurium* germs survived longer (85 days).

M í k o v á (1997) stated that the minimum pH for the growth of salmonella is 3.8, optimum 7 and maximum 9. The pH values of the solid fraction used in our experiment were in the range mentioned above therefore this substrate represented a suitable medium for the survival of salmonellae.

The numbers of indicator microorganisms recorded in winter and summer periods are comparable with values reported by O n d r a š o v i c o v á et al. (1994) during the storage of slurry with the difference that the results of the author mentioned showed considerable decrease in the number of coliform and fecal coliform microorganisms during 6-weeks of storage while our experiment showed considerable decrease only in psychrophilic microorganisms in summer and fecal streptococci in winter.

High contamination with indicator microorganisms was recorded by V e n g l o v s k ý et al. (1994) and P l a c h á et al. (1997) who detected higher numbers of coliform and fecal coliform bacteria in the solid fraction of wastewaters than in the inflow to the wastewater treatment plant.

Our results as well as results of other authors - V e n g l o v s k ý et al. (1994); O n d r a š o v i c o v á et al. (1994); P a c a j o v á et V e n g l o v s k ý (1997) indicate that the solid fraction of pig slurry can be contaminated with high numbers of pathogenic microorganisms and therefore increased attention should be paid to its handling and processing.

N i e w o l a k (1994) stated that microorganisms (*Escherichia*, *Salmonella*) introduced to the soil by application of contaminated pig slurry can penetrate to

depths of 160-180cm. H e n r y et al. (1995) isolated salmonellae from pasture after 2 months and from soil after 8 months following the application of contaminated pig slurry. For this reason the proper treatment of contaminated slurry before its application on land should be ensured. The most suitable way of treatment of the solid fraction of pig slurry is the composting. N i e w o l a k (1997), N o v á k (1994) and P l a c h ý (1995) stated that the composting results in significant decrease in the number of pathogenic bacteria, fungi and eggs of parasites and in production of high-quality manure with high portion of humic substances.

## 5. References

**AHMED, A.U., SORENSEN, D.L.:** Kinetics of pathogen destruction during storage of dewatered biosolids. *Water Environment Research*, Vol. 67, No. 2, 1995: 143—150

**APHA, AWWA, WPCF :** *"Standard Methods for the Examination of Water and Wastewater"*. Washington, 16th edition, 1985.

**CSN 83 0531:** Microbiological analysis of surface water (In Czech), 1983

**CSN 830540.** Chemical and physical analysis of wastewaters (In Czech), 1982

**DEAN, R.B., LUND, E :** *Water reuse: Problems and solutions*, 1981: 94—99

**HENRY, D.P., FROST, A.J., O'BOYLE, D., CAMERON, R.D.A.:** The isolation of salmonellas from piggery waste water after orthodox pondage treatment. *Australian Veterinary Journal*, Vol. 72, No. 12, 1995: 478—479

**JURIŠ, P., PLACHÝ, P., DUBINSKÝ, P., VENGLOVSKÝ, J., TÓTH F.:** The influence of aerobic stabilisation of pig slurry under laboratory conditions on the survival of *Salmonella typhimurium* and *Ascaris suum* (In Slovak). *Vet. Med. - Czech*, 38, 1993 (9): 553—558

**MÍKOVÁ, K.:** Problems of salmonellas in foods (In Czech). *Náš chov*, 8, 1997: 42—43

**MITSCHERLICH, E., MARTH E.H.:** Special Influences of the Environment. In: *Microbial Survival in the Environment*. Springer-Verlag, Berlin Heidelberg New York Tokyo, 1984: 728—744

**MULLER, W.:** Die Lebensfähigkeit von Salmonellen in belüftem kommunalem Abwasser. *Schlacht und Viehhof Zeitung*, 9, 1973: 332—336

**NIEWOLAK, S.:** The sanitary and Bacteriological Estimation of Surface and Underground Waters in the Region of a Pig Slurry Agricultural Utilization. *Polish*

Journal of Environmental Studies, Vol. 3, No. 1, 1994: 31—37

**NIEWOLAK, S., SZELAGIEWICZ M.:** Sanitary — Bacteriological and Parasitological Estimation of Sewage Sludges from Chosen Sewage Treatment Plants on the Mazurian Lake District and Utilization in Agriculture, Polish Journal of Environmental Studies, Vol. 6, No. 3, 1997: 45—51

**NOVÁK, P.:** Dynamics of indicator microorganisms in the process of composting of agricultural wastes (In Czech). Proceedings "Ecology and Veterinary Medicine", Košice, May 24-25: 69-72

**ONDRAŠOVICOVÁ, O., ONDRAŠOVIC, M., PARA, L., VARGOVÁ, M.:** Changes of some chemical and microbiological parameters of slurry during storage and addition of chemical disinfectants (In Slovak). Zivocíšna výroba, 39, 1994: 365—374

**PACAJOVÁ, Z., VENGLOVSKÝ, J.:** The influence of various doses of zeolites on plate counts of salmonellae, coliform and fecal coliform microorganisms in pig slurry under laboratory conditions. (In Czech) Vet. Med., 42, 6, 1997: 161—164

**PLACHÁ, I., VENGLOVSKÝ, J., LAŠANDA, V., PLACHÝ, P.:** Survival of *Salmonella typhimurium* in the solid fraction from a pig farm waste water treatment plant, (In: Czech), Vet. Med., 42, 5, 1997: 133—137

**PLACHÝ, P.:** Helminths eggs in processes of treatment municipal wastewaters. Phd Habil. Work (In Slovak), Parasitological Institute of the Slovak Academy of Sciences, Košice, 1995

**STRAUCH, D.:** Survival of pathogenic micro organisms and parasites in excreta, manure and sewage sludge. Rev. sci. tech. Off. int. Epiz., 10 (3), 1991: 813 846

**VENGLOVSKÝ, J., JURÍŠ, P., SOKOL, J.:** Survey of the efficiency of some waste treatment plant systems on pig farms in Slovakia (In Slovak). Vet.Med., 39: 677—686

## Adsorption properties of zeolite (clinoptilolite) and bentonite applied to pig slurry.

*Propriétés d'adsorption de zeolite (clinoptilolite) et bentonite apporté à du lisier de porc.*

**Venglovský, J., Sasáková, N., Paèajová, Z., Plachá, I, Juris, P\***

Research Institute of Experimental Veterinary Medicine,

040 01 Košice, Hlinkova 1/A, Slovak Republic. \* Region State Veterinary Doctor.

E-mail : venglov@tuke.sk

### Abstract

*The influence of two natural absorbents, zeolite (clinoptilolite) and bentonite, applied to pig slurry, were studied with regard to physical-chemical and microbiological properties of the mixtures obtained. The investigations were carried out for 14 days and the concentrations of ammonia nitrogen, total nitrogen and phosphorus as well as chemical oxygen demand in the supernatant were determined after 30 min, 2 h, 5 h, 24 h, 7 days of contact. The addition of both natural materials resulted in considerable decrease in the concentration in the supernatant of all chemical parameters studied as early as after 2 hours of contact till the experiment for zeolite (by up to 59% for  $N-NH_4^+$ , 88% for  $COD_{Cr}$ , 61% for  $N_t$ , and 93% for  $P_t$ ) and after 24 h up to the end of the experiment for bentonite (by up to 66% for  $N-NH_4^+$ , 88% for  $COD_{Cr}$ , 58% for  $N_t$ , and 95% for  $P_t$ ), in comparison with the control. The plate counts of the observed groups of microorganisms were also decreased.*

Keywords : zeolite, bentonite, pig slurry, solid fraction

### Résumé

L'influence de deux adsorbants naturels, la zeolite (clinoptilolite) et la bentonite, apporté à du lisier de porcs a été étudiée du point de vue des propriétés physico-chimiques et microbiologiques du produit. L'essai a été réalisé sur une durée de 14 jours au cours desquels la concentration en azote ammoniacal, en azote total et en phosphore, ainsi que la demande chimique en oxygène dans le surnageant, ont été mesurés après 30 min, 2h, 5h, 24h, 7 jours. L'ajout de ces deux produits naturels diminue très rapidement tous les paramètres mesurés et ce deux heures après l'ajout de zeolite : jusqu'à 59% de l' $N-NH_4^+$ , 88% de réduction de la DCO, 61% de l'azote et 93% du phosphore total ; et 24 h après l'ajout de bentonite (réduction de 66% de la teneur en  $NH_4^+$ , 88% de la DCO, 58% de l'azote total et 95% du phosphore total). Les comptages microbiens témoignent également d'une réduction important de tous les groupes de microorganismes.

Mots-clés : zeolite, bentonite, lisier porc, phase solide.

## 1. Introduction

Agriculture and mainly the animal production belong among important sources of environmental pollution in Slovak Republic. Animal farms operating on a large scale, particularly those concentrating on rearing of pigs, produce large quantities of excrements which pose problems with regard to spreading of pathogens and releasing air contaminants and odours. The problems are frequently intensified by unsuitable storage and handling of slurry ( Strauch, 1980, Ondrašoviè et al., 1996).

One of the noxious gases which pollute the environment is ammonia. This gas is produced by bacterial and enzymatic activity in the excrements of animals and is subsequently released into the animal house space and the outer atmosphere. It has toxic effect on housed animals, supports spreading of aerogenic infections and affects directly the immediate surroundings of the farms. In case of its spreading to longer distances it also adds to acidification of soil, eutrophication of water bodies, corrosion of buildings and others. In addition to that its release to the atmosphere means considerable losses of the manuring component of excrements (Amon, 1997).

One of the ways how to decrease the unfavourable effects of excrements on the environment is the construction of water treatment plants on farms with high concentration of animals. This is practised in many European countries in which the quantity of wastes produced by farm animals is higher than the soil purifying capacity can support (Boiran et al., 1996). The wastewater treatment plants which operate on pig farms are based mostly on the aerobical processes of treatment and most frequently comprise mechanical, chemical and aerobic-biological stages.

Problems may also arise in the process of treatment of the solid fraction of pig slurry obtained by separation on vibrating screens. This fraction is important from the epizootiological point of view as it is frequently associated with possible concentration of bacterial and viral pathogens and various stages of endoparasites (Plachý, Juriš, 1994).

Bentonites and zeolites are natural aluminosilicates. The essential component of bentonites is montmorillonite which forms crystals of the smallest size of all clay minerals. Zeolites have three dimensional crystalline structure with channels of molecular dimensions. They exhibit adsorption and ion exchange properties and may find use in the treatment of animal excrements.

The aim of the present study was to investigate the possibilities of utilization of natural zeolite (clinoptilolite) and bentonite from Slovak deposits in the treatment of pig slurry from large-capacity pig farm using literless technology of pig fattening.

## 2. Materials and methods

Zeolite (from Nizný Hrabovec; powder form) and bentonite (from Jelšovský Potok, powder) was added to pig slurry in the amount of  $50 \text{ g.l}^{-1}$ . The mixture obtained was mixed for 10 min and stored at room temperature ( $18\text{-}19^\circ\text{C}$ ). Slurry without any amendment served as a control. Samples for physical-chemical and microbiological examinations were taken from the mixtures in the intervals of 30 min, 2, 5 and 24 h and 7 and 14 days after adding zeolite and bentonite. Samples were observed visually and examined for pH, dry matter, total nitrogen, ammoniacal nitrogen and COD according to Slovak standard STN 83 0540 and Sedláček et al. (1978), and for total phosphorus according to the standard APHA methods (1985). The methods and results of microbiological examination were published elsewhere.

## 3. Results and discussion

Efficient management of animal wastes involves maximum recycling of nutrients and avoidance of air, soil and water pollution (Svoboda, 1989). The optimum utilization of pig slurry and evaluation of its quality and manuring value is based on its chemical parameters which are affected by many factors including the time, temperature and way of storage (Ondrašovičová, 1994).

The results of our chemical examinations are presented in Fig. 1 - 5.

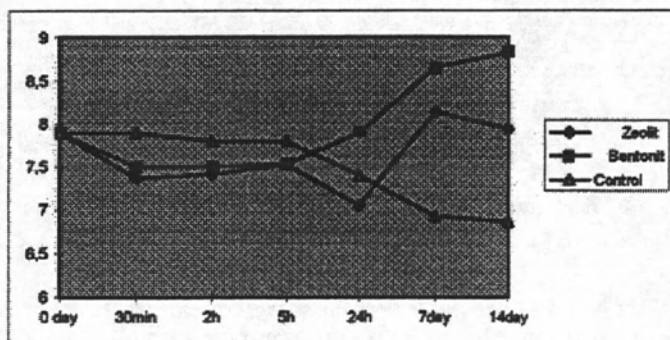

*Figure 1*  
Concentration of hydrogen ions in pig slurry treated with zeolite Z ( $50 \text{ g.l}^{-1}$ ) and bentonite B ( $50 \text{ g.l}^{-1}$ ) in dependence on the time of contact in comparison with the control (K).

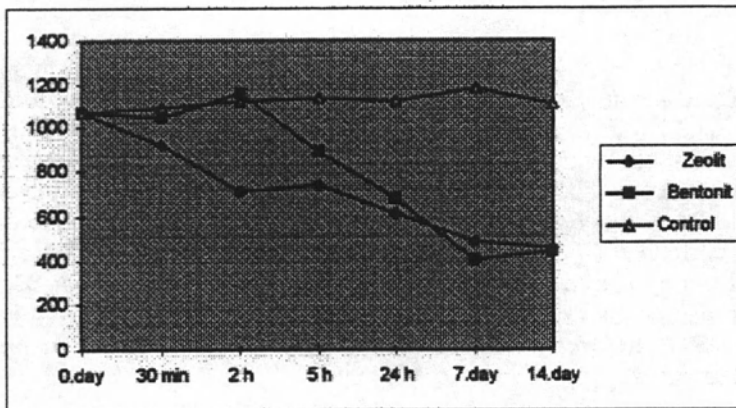

**Figure 2**  
*Concentration of ammonia in mg/l in pig slurry treated with zeolite Z (50 g.l<sup>-1</sup>) and bentonite B (50 g.l<sup>-1</sup>) in dependence on the time of contact in comparison with the control (K).*

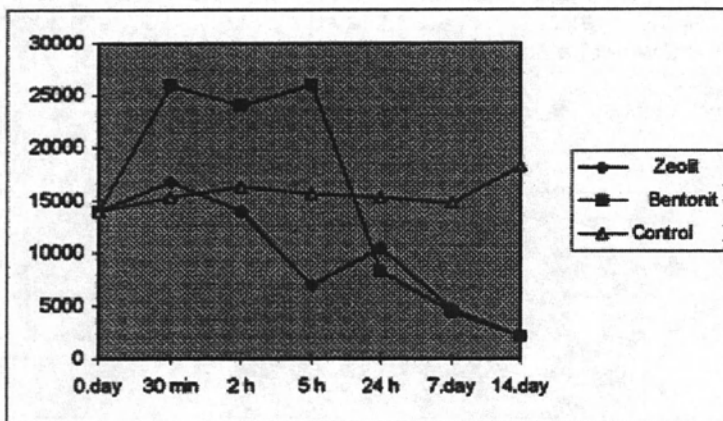

**Figure 3**  
*Concentration of chemical oxygen demand in mg/l in pig slurry treated with zeolite Z (50 g.l<sup>-1</sup>) and bentonite B (50 g.l<sup>-1</sup>) in dependence on the time of contact in comparison with the control (K).*



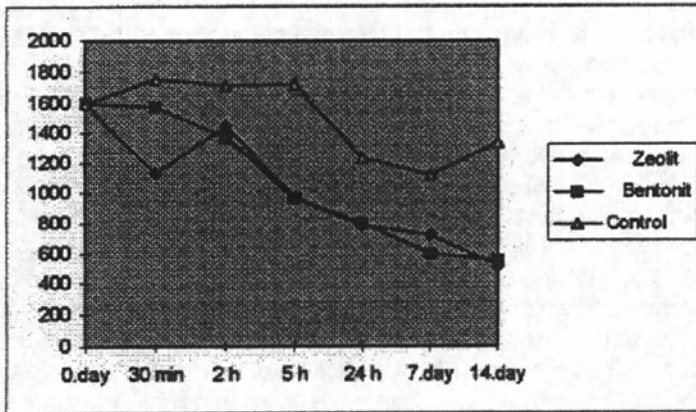

Figure 4

Concentration of total nitrogen in mg/l in pig slurry treated with zeolite Z ( $50 \text{ g.l}^{-1}$ ) and bentonite B ( $50 \text{ g.l}^{-1}$ ) in dependence on the time of contact in comparison with the control (K).

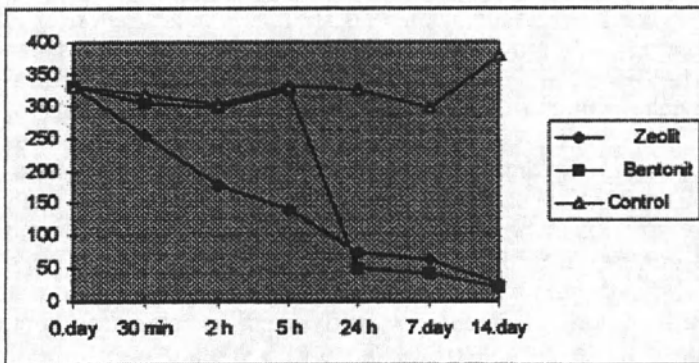

Figure 5

Concentration of total phosphorus in mg/l in pig slurry treated with zeolite Z ( $50 \text{ g.l}^{-1}$ ) and bentonite B ( $50 \text{ g.l}^{-1}$ ) in dependence on the time of contact in comparison with the control (K).

Visual observations showed that the mixture of zeolite and slurry sedimented in a similar way as was described by Vargová et al. (1995) while the mixture containing bentonite formed almost homogeneous gelatinous mass without any supernatant. Separation of this mixture to solid and liquid fractions occurred in the course of 24 h.

Figure 1 shows the changes in pH after the addition of zeolite and bentonite in comparison with the control. The differences between the values of pH for the zeolite and bentonite mixtures and the control increased gradually and were the highest at the end of the period of observation.

Significant differences between experimental mixtures and the control slurry were

observed in the concentration of ammoniacal nitrogen (Fig. 2). The mixture of slurry and zeolite exhibited significant decrease in the concentration of  $\text{N-NH}_4$  in the supernatant in comparison with the control as early as after 30 min of contact and the effect of this adsorbent was observed till the end of the period of observation. The effect of bentonite on this parameter became evident after 5 h of contact reaching maximum effectiveness (66%) after 7 days. The addition of either zeolite or bentonite resulted in almost 50 % decrease in  $\text{N-NH}_4$  concentration as early as after 24 h of contact with the slurry.

The values of COD in the supernatant also showed significant differences in comparison with the control (Fig.3). The efficiency of removal of COD by zeolite and bentonite reached 67 and 69 % resp. after 7 days of contact and 88 % for both adsorbents after 14 days of contact. The effect of bentonite was delayed due to poor separation of phases in the first hours of observation.

The effect of bentonite and zeolite on the decrease in total N in the supernatant appeared almost immediately after adding these materials to the slurry and persisted throughout the experiment copying more or less the behaviour of concentrations of ammonia (Fig.4).

Very interesting were the results obtained for the concentration of total P in the supernatant (Fig. 5). We may speculate that the decrease in this parameter was related to better sedimentation of the solid portion of slurry after the addition of sorbents, particularly zeolite.

Our results support the findings of V a r g o v á (1994) about the prospective use of zeolite in the treatment of excrements of farm animals already in the initial stages of the treatment process when this material can contribute to better sedimentation of suspended particles and decrease in ammonia nitrogen, COD,  $\text{N}_t$  and  $\text{P}_t$  in the supernatant. The sediment can be combined with the solid fraction obtained in the first mechanical stage of treatment and used in plant production. Similar considerations apply to bentonite. Zeolite and bentonite amendment of soil can have favourable effect on structural properties of soil, retaining of moisture and balance of nutrients. Simultaneous use of very small quantities of both materials appears promising, especially in countries which have deposits of these sorbents, and deserves further testing.

#### 4. References

**American Public Health Association (APHA)** : Standard Methods for the Examination of Water and Wastewater. 16th edition, Washington, 1985.

**Amon, M., Dobeic, M., Sneath, R.W., Phillips, V.R., Misselbrook, T.H., Pain, B.F.**: A Farm-scale study on the use of Clinoptilolite Zeolite and De-Odorase for reducing odour and ammonia emissions from broiler houses. In: : Bioresource Technology 61 (1997) 229-237.

**Boiran, B., Couton, Y. Germon, J.C.:** Nitrification and denitrification of liquid lagoon piggery waste in a biofilm infiltration-percolation aerated system (BIPAS) reactor. In: *Bioresource Technology* 55 (1996) 63-77.

**Ondrašoviè, M., Para, ¼., Ondrašovièová, O., Vargová, M., Koèišová, A.:** Veterinary care about the environment (In Slovak). Košice, 1996.

**Ondrašovièová, O., Ondrašoviè, M., Para, ¼., Vargová, M.:** Changes of some chemical and microbiological parameters of slurry during storage and after addition of chemical disinfectants (In Slovak). *Zivoèišná výroba*, 39, 1994 (4): 365-374.

**Plachý, P., Juriš, P.:** The risk of spreading of helminths with sludges to agricultural soil (In Slovak). *Slov.vet.èas.*, 19, 1994: 15-18.

**Sedláèek, M.:** Methods of analysis of sludge and solid wastes (In Czech). Státní zemìdìlské nakladatelství, Praha, 1978.

**Strauch, D., Baader, W., Tietjen C.:** Wastes from animal production (In Slovak, transl.). *Príroda*, Bratislava, 1980.

**STN 83 0540 :** Chemical and physical analysis of wastewaters (In Slovak), 1982.

**Svoboda, I. F.:** A Computer program for farm waste management. In: *Wat. Sci.* Vol.21, Brighton, pp. 1865-1868, 1989.

**Vargová, M., Venglovský, J., Paèajová, Z., Chandoga, P., Plachá, I., Koloušek, D.:** The possibilities of utilization of natural and synthetic zeolite in the treatment of pig slurry (In Slovak). In: *Proc. " Ecology and veterinary medicine "*, Košice, 1994: 101-107.



# Hygienic requirements in aerobic and anaerobic treatment of biological wastes

*Besoins en hygiénisation lors du traitement aérobie et anaérobie de déchets biologiques.*

**Böhm, R.**

Universität Hohenheim, Institut für Umwelt- und Tierhygiene - 460  
D-70593 Stuttgart. Germany.

## Abstract

Biological wastes generally contain various bacteria, fungi and viruses which are obligatory or facultative pathogens for man and animals or plants.

A strategy will be presented which will lead to a safe product from the point of view of human, animal and plant health as well as of undesired product side effects. The main elements of this strategy are :

- validation of the aerobic and anaerobic process concerning the inactivation of representative bacterial, fungal and viral pathogens as well as weed seeds,
- continuous control of main process parameters leading to the inactivation of the pathogens and seeds, e.g. temperature, pH-value, exposure time.
- regular control of the final product for the occurrence of representative indicator organisms like Salmonella.

Keywords: Biowastes, hygienic requirements, process validation

## Résumé

Les déchets biologiques contiennent généralement diverses bactéries, champignons et virus qui sont des pathogènes stricts ou facultatifs pour les humains, les animaux et les plantes.

Une stratégie est présentée qui conduit à un produit sain du point de vue des individus, des animaux et des plantes. Les éléments principaux de cette stratégie sont :

- validation des procédés aérobie et anaérobie du point de vue de l'inactivation des bactéries, champignons et virus pathogènes, ainsi que des graines de mauvaises herbes.
- contrôle continu des principaux paramètres du procédé conduisant à l'inactivation des pathogènes et des graines, tels que la température, le pH, le temps d'exposition.
- contrôle régulier du produit final par rapport à la présence de microorganismes indicateurs tels que les salmonelles.

Mots-clés : biodéchets, besoins en hygiène, validation procédés.

# 1. Introduction

The origin and nature of organic wastes is always causing a hygienic risk in storage, collection, handling, processing and utilization. Those risks are existing either if the organic wastes are collected and processed source separated (biowastes) or if they are collected together with other wastes from households or processing industries. Due to the fact that most organic materials collected from households or processing industries may contain pathogenic microorganisms which can affect the health of man, animals or plants as well as seeds or parts of plants which will cause undesired side effects in agricultural or horticultural use. Hygienic principles must be followed in collection, transport, processing, storage and distribution of raw materials as well as the final product.

- Three main types of risks mainly related to pathogens for man and animals have to be considered in collection and processing of organic wastes (BÖHM et al., 1996, BÖHM, 1995)
- occupational health risks
- environmental risks
- risks concerning the product safety.

## 2. Hygienic risks connected with products from biological wastes.

A compilation of bacterial, fungal, parasitic and viral pathogens for man and animals which may be present in organic wastes are given in Tab. 1. With regard to plant pathogens an extensive list of viruses, bacteria, fungi and seeds is given by MENKE (1992).

Bacteria	Citrobacter, Clostridia, Enterobacter, Escherichia coli, Klebsiella, Proteus, Pseudomonas, Salmonella, Serratia, Staphylococci, Streptococci, Yersinia
Fungi	Aspergillus-species, e.g. <i>Aspergillus fumigatus</i>
Viruses	Adenovirus, Coxsackievirus, ECHO-Virus, Enterovirus, Hepatitis A-Virus, Herpesvirus suis, Paramyxovirus, Parvovirus, Pestivirus, Poliomyelitisvirus, Reovirus

Table 1

*A survey on obligatory and facultative pathogens for man and animals which had been isolated from biological and household wastes*

Since it is impossible to supervise a product like compost for each of the pathogenic agents which may occur, other strategies have to be used in order to assure the hygienic safety of the processed material. The first step in such a strategy is to find out a representative indicator organism which may be used for checking the hygienic safety of the product as well as for evaluating the anaerobic or composting process for its capability to inactivate pathogens which are of epidemiological relevance. The second step which is necessary in this connection

is to define hygienic requirements for the process itself, since due to the high volume of the product to be controlled as well as to the inhomogeneity of distribution of pathogens in the material only a final product processed in a validated process should be distributed to the consumer. This means, that the following two steps are necessary to assure the hygienic safety of the product:

- hygienic validation of the aerobic or anaerobic process,
- continuous control of main process parameters leading to the inactivation of the pathogens and seeds, e.g. temperature, pH-value, exposure time,
- investigation of the final product for the presence of representative indicator organisms.

### 3. Process validation

The validation of the process for the treatment of organic wastes with respect to hygienic safety for animals, man and plants may be done in several ways. Concerning the process of composting the German LAGA M10 (1995) offers a relatively broad approach in solving this problem, which is as follows:

Process safety concerning the inactivation of relevant transmissible agents for man and animals is validated in two steps. The first step is the validation of the process as designed by the producer of the technical equipment in a basic procedure, the second step is a bringing-into-service validation of a composting plant with the typical input material under practical conditions. In both validation procedures *Salmonella senftenberg* W 775 (H<sub>2</sub>S negative) is used as test organism exposed in specially designed test carriers (RAPP, 1995, BÖHM et al., 1997). The test organisms used with respect to phytohygienic safety are Tobacco mosaic virus, *Plasmodiophora brassicae* and seeds of *Lycopersicon lycopersicum* (L) breed St. Pierre (BRUNS et al. 1994, POLLMANN and STEINER, 1994). Testing is done twice, in summer- and in wintertime. Concerning the phytohygienic validation the bringing-into-service procedure is repeated at least every two years as a consecutive validation.

This is a very complete and safe system designed for voluntary quality assurance. Due to economical considerations an obligatory system should be simplified and only a one step procedure should be the aim, which must be the bringing-into-service validation. Moreover the above mentioned system is limited to the composting process, a comparable procedure has to be invented for biogas-plants. A scheme how this validation could be organized taking into account the annual throughput of material in the plants is given in Table 2 from the draft of the German « Biological Wastes Ordinance ». The validation with pathogens and seeds may be regarded as « direct process validation » and must be accompanied by continuous recording of measurable process-data like temperature, pH-value, humidity etc. In order to detect deviations and disturbances of the process over the whole year, which may result in an insufficient microbicidal effect. The system of process validation has to be completed by a continuous supervision of the final product, at least twice a year.

INVESTIGATED PARAMETER		DIRECT VALIDATION OF THE PROCESS	INDIRECT PROCESS SUPERVISION	SUPERVISION OF THE FINAL PRODUCT
Hygienic safety concerning risks for man, animals and plants		- New constructed plants (within 12 month after opening of the plant) - Already validated plants if new technologies have been invented or if the process has been significantly modified (within 12 months after invention or modification) - Existing plants without validation within the last five years before this validation strategy was invented (within 18 months)	- Continuous registration of temperature at three representative locations in the process, responsible for the inactivation of the microorganisms and seeds - Recording of process data (e.g. turning of windrows, moisture of material, starting and finishing data)	Regular investigation of the final product for hygienic safety <sup>2), 3)</sup>
Number of test trials		2 Test trials, at open air composting plants at least one in wintertime	Continuous data recording to be filed for at least five years	Continuously all over the year at least - semiannual (plants with =3000 t/a throughput) - quarterly (plants >3000 t/a throughput)
Number of test organisms	Human and veterinary hygiene	1 test organism (Salmonella senftenberg W 775, H <sub>2</sub> S-neg.)	-	No salmonella in 50 g product detectable
	Phytohygiene	3 test organisms (Plasmodiophora brassicae, tobacco mosaic-virus, tomato seeds)	-	Less than 2 seeds capable of germinating and/or reproducible parts of plants in 1 L of product
Number of samples Sample per test-trial: Human and veterinary hygiene Phytohygiene		24 <sup>1)</sup> 36 <sup>1)</sup>	-	Throughput of the plants in t/a 1. = 3000 (6 samples per year) 2. > 3000-6500 (6 samples per year plus one more sample for every 1000 t throughput) 3. > 6.500 (12 samples per year plus one more sample for every 3000 t)
Total		60		

**Table 2**

**Example of a validation and supervision strategy for biogas and composting plants and the resulting products**

- 1) At small plants half the number of samples (= 3000 t/a)
- 2) Every statement concerning the hygienic safety of the product is always based on the result of the supervision of the final product together with the result of the validation of the process
- 3) Every sample is a „mixed sample“ (about 3 kg) based on five single samples of the final product

## 4. Hygienic Safety of the Product

As mentioned above, the investigation of the final product in order to detect every pathogen which may be present in the material is impossible, therefore representative indicator organisms have to be determined from the point of view of



human and animal health as well as for the purpose of safe plant-breeding and production. Those indicator organisms must fulfill several requirements :

- they have to be present with a high probability in the raw materials
- the transmission via final product must be a factor in epidemiology
- the indicator should not be involved in the aerobic or anaerobic biotechnological process itself
- the indicator should not be an organism which is generally present in soil and soil related materials
- the method for isolation and identification must be simple, definitely and reliable if applied to a substrate with a complex microbiological matrix which will not be sterile.

With respect to public health and veterinary requirements several indicators and parameters are in discussion :

- *Salmonella* spp.
- Enterococci (Streptococci of group E)
- *Staphylococcus aureus*
- Enterobacteriaceae
- *Escherichia coli*
- *Clostridium perfringens*
- Sulfite reducing Clostridia
- Eggs of nematodes
- Larvae of nematodes.

Since compost for example is a product of a microbial degradation process and the knowledge about the microbiological ecology of compost and compost related materials is still limited, it must be warned to use isolation and identification techniques common in clinical microbiology without careful validation in combination with the involved sample materials. The knowledge about the microbial flora of products resulting from a mesophilic or thermophilic biogas process is even less, especially with respect to the selection of an anaerobic flora and growth inhibiting microbial byproducts. The variety of species to be present in environmental samples and the products of a composting- or biogas-process by far exceeds the limited number of species to be taken into account in se- and excreta as well as in body fluids and the variability in species is high and not yet fully understood. Moreover, microbial parameters which are used in the field of waterhygiene and food inspection are not applicable to substrates like compost because most of those indicators belong to the indigenous flora of agricultural soils (BÖHM, 1995). If the limited reliability and applicability of methods adopted from clinical microbiology and water inspection for the intended field of use is taken into account as well as the fact that the exclusion of organisms which generally may be found in normal soils makes no sense for a substrate and fertilizer resulting from an aerobic or anaerobic biotechnological process, the following microbial parameters are inappropriate: Enterococci, *Staphylococcus aureus*, Enterobacteriaceae, *Escherichia coli*, *Clostridium perfringens* and sulfite reducing Clostridia.

The only parameter which seems to be useful and reliable in this connection is the presence or absence of salmonellas. Salmonellas are found in a rate of up to 90 % in biowaste bins, this means, that due to mixing the content of many sources during transport the waste delivered at the biowaste treatment plant contains with a high probability salmonellas in various concentrations. Since it is known that the probability to identify a positive sample is basically related to the amount of investigated material a compromise between feasibility and reliability has to be found. It is proposed to investigate 50 g of compost for the presence or absence of salmonellas with the method described in principle in the LAGA M10 using a pre-enrichment in buffered peptone water and an enrichment step (EDEL and KAMPELMACHER, 1969, RAPPAPORT et al.; 1956, VASSILIADIS, 1983).

This leads to the problem of indicator organisms from the point of view of phytohygiene. No virus, fungus or bacterium pathogenic for plants has been found until now which is of comparable importance as salmonellas are for the above mentioned purpose. The only indicator which is widely distributed in biological wastes from households are tomato seeds. Even knowing, that this indicator will not cover totally all requirements, it seems to be reasonable and feasible to define the term « phytohygienic safety » of the product as follows: The final product should not contain more than 2 seeds capable to germinate and/or reproducible parts of plants in 1 l. A suitable test-method is described by BUNDESGÜTEGEMEINSCHAFT KOMPOST (1994).

## **5. Final Remarks**

In order to assure hygienic safety of products treated by a biotechnological aerobic or anaerobic process deemed to be applied in agriculture and horticulture a three step control system is recommended which is based on approved methods and which is designed to minimize the costs and labour on one side and allows to come to an optimal product safety by using additive effects on the other side. Fig. 1 summarizes the strategies to be applied in order to reach this aim.

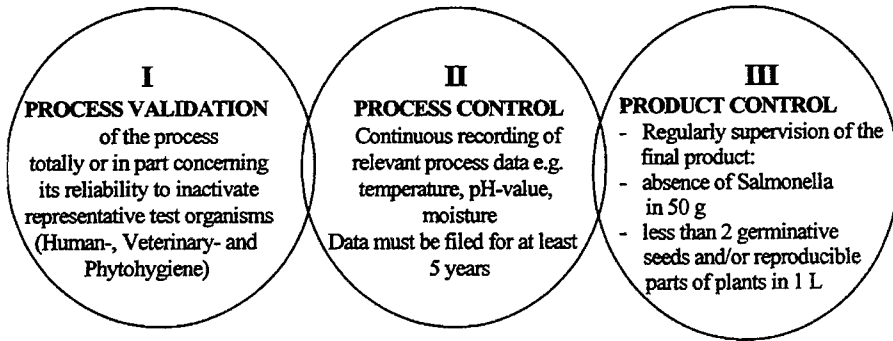

*Figure 1*

*Hygienic requirements for aerobic and anaerobic treatment of organic wastes*

## 6. References

**BÖHM, R.** (1995), Die Problematik der Festsetzung mikrobiologischer Grenz- und Richtwerte in der Umwelthygiene, in: Grenzwerte und Grenzwertproblematik im Umweltbereich (Arndt, V., Böker, R., Kohler, A., Eds.), pp 75-85, Ostfildern: Verlag Günter Heimbach.

**BÖHM, R., FACK, Th., PHILIPP, W.** (1996), Anforderungen an die biologische Abfallbehandlung aus der Sicht des Arbeitsschutzes, in: Biologische Abfallbehandlung III, (Wiemer, K. und Kern, M., Eds.), pp 335-365, Witzenhausen: M.C. Baeza-Verlag.

**BÖHM, R., FINK, A., MARTENS, W., PHILIPP, W., WEBER, A., WINTER, D.** (1997), Abschlußbericht zum Forschungsvorhaben 02-WA 9257/5 "Veterinär- und seuchenhygienische Untersuchungen zur Überprüfung von Gülleaufbereitungsverfahren und der erzeugten Gülleaufbereitungsprodukte", Institut für Umwelt- und Tierhygiene, Universität Hohenheim. D-70593 Stuttgart.

**BRUNS, C., GOTTSCHALL, R., MARCINISZYN, E., SCHÜLER, C., ZELLER, W., WOLF, P., VOGTMANN, H.** (1994), Phytohygiene der Kompostierung - Sachstand, Prüfmethode, F.- und E.-Vorhaben, Tagungsband "BMFT-Statusseminar, Neue Techniken der Kompostierung", pp 191-206, Berlin: Umweltbundesamt, FB III, Postfach 330022, D-14191 Berlin.

**BUNDESGÜTEGEMEINSCHAFT KOMPOST e.V.** (1994), Methodenhandbuch zur Analyse von Kompost Nr. 222, Methode 8. Schönhauser Str. 3, D-50968 Köln.

**EDEL, W. and KAMPELMACHER E.H.** (1969), Salmonella isolation in nine European laboratories using a standardized technique. Bull. With. Health. Org. 41, 297-306.

**GRÜNER, C.** (1996), Gesundheitszustand und Belastung von Beschäftigten im Abfallbereich. Erste Ergebnisse und Schlußfolgerungen für die Praxis, in: Biologische Abfallbehandlung III (Wiemer, K., Kern, M., Eds.), pp 315-334, Witzhausen: Baeza-Verlag.

**MENKE, G.** (1992), Hygienische Aspekte der Bioabfallkompostierung. Teil 1: Phytohygiene, in: Proc. Symposium des Umweltministeriums Baden-Württemberg und der LG-Stiftung "Natur und Umwelt", 26. März 1991 in Stuttgart, "Bioabfallkompostierung - Chance der Abfallverwertung oder Risiko der Bodenbelastung?", pp 68-73 und Tab. 1-5. Stuttgart: LG-Stiftung „Natur und Umwelt, Königstraße 3-5, D-70173 Stuttgart.

**POLLMANN, B. and STEINER, A.M.** (1994), A standardized method for testing the decay of plant diaspores in biowaste composts by using tomato seed, *Agribiological Research* 47, 1, 27-31.

**RAPP, A.** (1995), Hygienisch-mikrobiologische Untersuchungen zum Verhalten von ausgewählten Bakterien und Viren während der längerfristigen Speicherung von Flüssigmist in Güllegemeinschaftsanlagen. Agrarwissenschaftliche Dissertation Universität Hohenheim.

**RAPPAPORT, F., KONFORTI, N., NAVON, B.** (1956), A new enrichment medium for certain *Salmonellae*, *J. Clin. Pathol.* 9, 261-266.

**VASSILIADIS, P.** (1983), The Rappaport-Vassiliadis (RV) enrichment medium for the isolation of *Salmonellas*: an overview. *J. Appl. Bacteriol.* 54, 69-74.

**Chairman's summary of part 4 bis**  
**Processing and handling of wastes**  
**Colin BURTON**

In a poster prepared by Heinonen-Tannski from the University of Kuopio, the results of aerobic treatments of cattle slurry are presented. A key factor is the reduction in pathogens in the slurry that has been collected through the long Finnish winter before it is landspread. The benefits of mesophilic and especially thermophilic treatment are clearly shown, but the final reduction of the process will be if the reduction in specific pathogens is both adequate and reliable.

Hunt of the USDA/ARS presented results from experiments to treat pig slurry using constructed wetlands. Motivating this work is the need to safely remove surplus nitrogen. Nitrification is thus a key part of this work and results were encouraging. In summary, over 10 kg/day of nitrogen can be removed (as denitrification gases) per hectare of wetland. Needless to say, this figure is well in excess of the typical capacity of cropland to take up nitrogen.

A poster for the SITA organisation was presented by Martel. He described a system based on composting to co-process pig slurry with sewage sludge. Of particular importance is the hygienic quality of the product produced.

A poster was displayed on the work of Senez of INRA-CMSE in collaboration with partners at ENESAD. Treatment of pig slurry was again the theme with a process comprising of separation (by centrifuge) followed by lagooning or aerobic treatment by trickling tower technology. The main treatment concerns were both organic matter (ie COD load) and nitrogen. The last poster was prepared by van Wagenberg and Backus of the Research Institute for pig husbandry in Holland. This was closely linked to the mineral book-keeping scheme being pioneered in Holland. The reported work was based around a model to assist in nutrient control around a farm ; unlike the other contributions, treatment did not directly feature in this work.



## **Working Group Reports**

1. Solid manure working group report : a survey by Dr. Harald Menzi (Chairman)
2. Heavy metals working group report : a survey by Mr Roger Unwin (Chairman)





# **Solid Manure in Europe.**

## **Results of a survey by the Working group on solid manure of RAMIRAN**

*Déjections solides en Europe.*

*Résultats d'une enquête d'un groupe de travail du réseau RAMIRAN.*

**H. Menzi<sup>1)</sup>, B. Pain<sup>2)</sup> and K. Smith<sup>3)</sup>**

<sup>1)</sup> Inst. of Environmental Protection and Agriculture Liebefeld (FAL-IUL), CH-3003 Berne, Switzerland

<sup>2)</sup> Inst. of Grassland and Environmental Research (IGER), North Wyke, Okehampton, Devon EX20 2SB, UK

<sup>3)</sup> ADAS, Woodthorpe, Wolverhampton, WV6 8TQ, UK

### **Abstract**

*An ad-hoc working group of the FAO-network on animal waste management conducted a survey on solid manure management in European countries. The questionnaire sent out to experts in 23 countries consisted of the chapters types of solid manure and quantities produced; solid manure composition; solid manure use; nutrient losses; regulations, laws and recommendations; research and literature concerning solid manure. Responses were received from Austria, Belgium, Bulgaria, Czech Republic, Denmark, Finland, France, Germany, Italy, Netherlands, Northern Ireland, Norway, Portugal, Sweden, Switzerland and the United Kingdom. The most important results are:*

- *Solid manure constitutes more than one third of the total manure production in Finland, England and Wales, Sweden, Switzerland, Italy and parts of Belgium.*
- *The data about solid manure production per animal and solid manure content varies considerably between countries, mainly because of differences in housing systems and farm management. An actual comparison between countries is difficult because of the lack of common definitions and terms.*
- *In most countries the most important solid manure category is that produced together with slurry in tied cattle stalls.*
- *Where possible, solid manure is mainly used on arable land, primarily potatoes, beet, maize and in northern countries cereals. Use on grassland is common primarily in mountain regions.*
- *Even though the scientific understanding of solid manure systems is considerable, especially in central and northern European countries, serious gaps remain, e.g. factors controlling solid manure composition, nutrient availability of solid manure (especially for nitrogen), long term efficiency of the nutrient cycle in solid manure farming systems. These gaps are greater than for slurry systems.*

Key words: solid manure, composition, management, utilisation, nutrient losses, survey, Europe

## Résumé

Le groupe de travail ad-hoc du réseau FAO sur la gestion des déjections animales a conduit une enquête sur la gestion des déjections solides (fumiers) en Europe de l'ouest. Le questionnaire transmis à différents experts de 23 pays contenait des rubriques telles que le type de déjections solides et les quantités produites, la composition des déjections, l'utilisation et la gestion, les fuites, les réglementations et recommandations, puis la recherche de références existantes sur les déjections solides.

Les réponses au questionnaire ont été obtenues pour les pays suivants : Autriche, Belgique, Bulgarie, République Tchèque, Danemark, Finlande, France, Allemagne, Italie, Pays-Bas, Irlande du Nord, Norvège, Portugal, Suède, Suisse et Royaume-Uni.

Les principaux résultats sont les suivants :

- Les déjections animales solides représentent plus du tiers des quantités totales de déjections produites en Finlande, Angleterre et Ecosse, Suède, Suisse, Italie et en partie Belgique.
- Les données sur la production de déjections solides par animal et le contenu de ces déjections sont très variables d'un pays à l'autre, dû principalement aux différents types de bâtiments.
- Dans la plupart des pays, les déjections solides les plus importantes sont celles produites en stabulation par les bovins.
- Lorsque cela est possible, les déjections solides sont utilisées sur cultures arables, principalement pommes de terre, betteraves, maïs et sur céréales dans les pays du nord.

L'utilisation sur prairies se rencontre plutôt dans les régions de montagne.

Les méconnaissances sur les facteurs qui conditionnent leur composition, la disponibilité en éléments nutritifs et l'incidence à long terme sur la fertilité des sols, sont encore plus accrues pour les déjections solides comparativement aux lisiers.

Mots-clés : déjections solides, composition, gestion, utilisation, fuites, enquête, Europe.

## 1. Introduction

Solid manure makes up an important part of the organic fertilisers utilised in European countries. For animal welfare reasons its importance is increasing in many countries. Due to variable farm structure and management (housing and storage systems; time, rate and crop of application etc.) the nutrient content and the use of solid manure differs considerably over Europe. This hinders the comparison

and exchange of national data and recommendations. At its last meeting in 1994 the ESCORENA Network on Animal Waste Management therefore established a working group to make a survey about existing knowledge, recommendations and research concerning solid manure in European countries. The working group formulated and distributed a questionnaire to all members of the network. After receiving responses from most central and northern European countries it is possible to make a first summary of the results, to compare national data and recommendations and to identify some gaps of knowledge which should be treated by the network or other multi-national groups of experts.

## **2. Organisation of the survey**

The questionnaire worked out by the working group consisted of six main chapters :

1. Types of solid manure and quantities produced
2. Solid manure composition
3. Solid manure use
4. Nutrient losses
5. Regulations, laws and recommendations
6. Research and literature concerning solid manure

To get as much information as possible in spite of limited scientific or statistical data, the questionnaire encouraged participants to give estimates based on personal experience where necessary. It also asked for existing practical recommendations to farmers and for copies of such documents (in English, German or French).

After presentation at the network workshop in 1996 the questionnaire was sent to about 140 experts in 23 countries (21 European countries, Canada, Israel). Up to date 20 responses from 16 countries were received: Austria (A), Belgium (B), Bulgaria (Bu), Czech Republic (CR), Denmark (DK), Finland (SF), France (F), Germany (D), Italy (I), Netherlands (NL), Northern Ireland (NI), Norway (No), Portugal (P), Sweden (Sw), Switzerland (CH), United Kingdom (UK). While some of the questionnaires were filled out by one expert only, others compiled the information given by several experts from different institutes (e.g. Germany, Switzerland, United Kingdom).

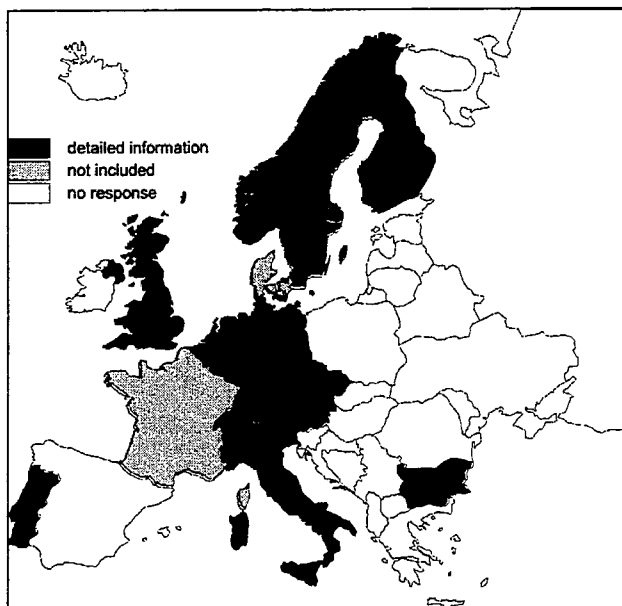

*Figure 1*  
*Countries included in this study*

As expected, some responders did not answer all questions and answers varied in detail. The most detailed information was provided by the UK, Switzerland and Sweden. For some aspects the examples from these two countries are therefore used for a more detailed discussion. From France and Denmark the responses received could not yet be integrated in this report because they did not match the structure of the questionnaire or were incomplete. Unfortunately, only a very limited response was received from Southern or Eastern European countries. It can be assumed, that at least for most countries where no detailed response was received in spite of personal contacts established (e.g. France, Denmark, Hungary, Ireland), either solid manure is of relatively low importance or solid manure management has not yet been a topic of scientific interest.

For practical reasons it was not possible to re-contact responders concerning incomplete answers or confusing data.

### **3. Results**

#### **3.1 Importance of solid manure**

Apparently, solid manure has the greatest importance in the Czech Republic, Finland and in parts of Belgium (Hesbaye region), where about 70% of the total manure production is reported to be solid manure. In Bulgaria up to 80% are

assumed including slurry transformed to solid manure in lagoons. High values are also reported in England and Wales (50%), Austria (40-50%), Sweden (approx. 40%), Switzerland (36%) and Italy (over 50% of cattle manure production). Other values reported are: Norway and Northern Ireland 10%, the Netherlands 6%.

The future development of solid manure production appears to be rather uncertain in most countries. From the Czech Republic the situation is reported to have stabilised after a phase of increasing importance due to problems with the slurry and animal welfare. An increasing importance is anticipated in the UK (mainly for pigs), in Switzerland, Germany, some districts of Norway and for cattle in Austria. In contrast, a decrease is expected in the Netherlands, in Sweden, in Finland and for pigs in Austria. In Italy, two experts expect a decrease, one an increase. The main reason given for an increase is animal welfare and consumers demand. In Italy, other advantages of solid manure mentioned are that it is easier to handle and store and that regulations are less severe than for slurry. The latter point could also apply in Switzerland. The main reason for an expected decrease is that solid manure is mainly produced on smaller farms, a significant number of which will probably close down in the future. From Sweden it is also reported that solid manure systems are not recommended because slurry, if correctly spread, will pose lower risks of environmental impacts. The Swiss example demonstrates that the importance of the two contrary developments can change in rather short time: Between 1960 and 1990 slurry systems replaced solid manure systems in most new buildings; in recent years animal friendliness became increasingly important. Therefore, a drastic change from slurry to solid manure systems is expected in the near future mainly for beef cattle and partly for pigs. Even between experts there is no consensus to the question, if slurry or solid manure systems are more ecologically sound.

According to the information received from Portugal and Bulgaria, the fertiliser value of manure in general has only recently been appreciated. Accordingly, manure management is still difficult to define and a differentiation between solid and liquid manure is very difficult.

### **3.2. Housing systems producing solid manure and their importance**

Housing systems and relevant terminology apparently vary considerably over Europe. It was therefore sometimes difficult to compare responses from different countries. Furthermore, information in some cases lacked detail (e.g. x% solid manure production of cattle with no information of percentage of animals concerned). Therefore, the following overview includes only countries with more detailed information.

The very variable terminology used in different countries, the different way of presenting the information and some misunderstandings concerning the questions clearly showed that the first and probably most important step in reaching an understanding about the importance of solid manure across Europe would be to draw up a common terminology for housing systems and manure types.

## Cattle

Housing systems producing only solid manure seem to be important mainly for beef cattle in the UK (60%), Sweden 10-20%), Finland (40-50%), Switzerland (10%), Germany and Italy. For dairy cows they are reported only from Sweden (5% of cows, 15% of young stock). In the Netherlands, Germany, Norway, Switzerland (15% of young stock) and Italy, whilst such appear to exist, they are of negligible importance only.

Housing systems producing solid manure which contains most of the dung and some urine and slurry were reported from Switzerland (30-70% of cows, 60% of young stock), Sweden (50-60%), Finland (approximately 50%), Italy (approx. 60% of cows) and Austria. In most cases such systems appear to be used in tied stalls with daily removal of the solid manure. The proportion of the excreta collected in the solid manure is variable, especially for urine. In Sweden, Finland and Switzerland differentiated information was given which shows a considerable variability even within the country. In Sweden 30 to 100% of the urine (together with most or all the dung) is collected in the solid manure depending on the type (straw, sawdust) and quantity of bedding material used. In Swiss systems only small proportion of urine and 50-90% of the dung is collected in the solid manure, depending on availability of straw, possibilities to use solid manure in arable crops and regional practice. Systems producing only solid manure on part of the surface and only liquid manure in other parts are reported for dairy cows in the UK (15%) and for beef cattle in Finland (40-50%). In Germany and Switzerland such systems are sometimes used in "Tretmist"-systems for beef cattle, where the bedding area is situated on a slightly inclined plain, such that the lower layers of the manure slowly move to the area without bedding where the manure is removed at regular intervals.

No details about cattle housing systems producing solid manure were received from the Netherlands, Norway and Northern Ireland where solid manure production is uncommon for cattle and from Belgium, Portugal, the Czech Republic and Bulgaria where detailed information on housing systems was apparently not available. Many countries also report significant regional differences in housing systems depending primarily on farm structure. Especially in Switzerland and Sweden differentiated information about manure production exist for the different housing systems.

In most countries only straw is used as bedding material for cattle. In Sweden some systems are also run with sawdust and in Finland peat is sometimes utilised. In most countries the amount used is 1.5-3 kg per cow per day in tied stall systems with solid manure plus slurry production and 5-14 kg per cow per day for solid manure-only systems. For systems producing solid manure on part of the surface values are 3.5-5.5 kg in Italy and 5-10 kg in the UK (depending on animal weight).

## Other herbivores

For horses all reports (CH, D, S, No, Bu) received are based on systems producing only, or primarily, solid manure. The amount of bedding material varies between 2.5 and 12 kg per animal per day. Usually straw is used; in Sweden and Norway also wood shavings or peat.

For sheep and goats reports came from Switzerland, the Netherlands, Norway and Bulgaria. In Switzerland and Norway it is clear that only solid manure is produced,

for the other countries it can be assumed. In Norway a wire mesh floor and wood shavings are utilised, otherwise straw is used as bedding material.

#### Pigs

For sows solid manure systems are important mainly in Austria (65 % of the animals), the UK (45%), Sweden (40-70%) and Finland (80%). They are of lesser importance in Germany (25% of manure production), Switzerland (3%) and Bulgaria (10% of the sows). In Norway, 5%, and in the Netherlands, 1.7%, of the manure production of pigs is in the form of solid manure without differentiation given between sows and fattening pigs. While only part of the urine is collected in the solid manure in the Scandinavian countries, other countries report mainly solid manure only systems. The bedding material apparently is straw, apart from Finland, Norway Italy and the UK where wood shavings or sawdust are also used.

Of the fattening pigs 45% in the UK, about 40% in Austria, 15% in Germany, 20% in Finland, 3% in Switzerland and less than 1% in Italy are kept on solid manure systems.

#### Poultry

Broilers and turkeys are predominantly kept on deep litter systems with wood shavings as bedding material (Germany and UK, straw also). In most countries hens also produce mainly solid manure, be it in deep pit systems where the manure is collected over a longer period or in belt systems (cages or aviary) with more frequent removal. Apparently, laying hen excreta are partly collected in liquid form in Italy (99%), Northern Ireland (50%), Sweden and the Netherlands (approx. 55%).

### **3.3. Solid manure production per animal unit**

#### Cattle

For tied housing systems producing solid manure and slurry the quantity of solid manure produced per dairy cow per year varies between 4.4 and 16 t. If values are standardised at 365 days housing period they still vary between 5.4 and 23.6 t. This wide variability can mainly be explained by the variable proportion of the excreta collected in the solid manure. The lowest values are reported from Switzerland (5.4, 8 and 9 t year<sup>-1</sup> depending on the region; 8 t year<sup>-1</sup> mean guide value) where, together with most of the urine a significant part of the dung is collected in the slurry. The highest values are reported from Sweden where all dung and 25-50% of the urine is collected in the solid manure. Values between 12 and 16 t are reported from Germany, Italy and Finland. From Switzerland and Sweden variable values are reported depending on regional practice, straw availability, utilisation opportunities for solid manure (CH) and proportion of urine collected (S).

For housing systems producing solid manure on part of the surface and slurry on the rest, solid manure quantities of 8 to 15 t per cow per year are reported. In the UK quantities are estimated at between 10 and 15 t according to animal weight (450 to 650 kg). The rest of the variability can probably be explained by the proportion of excrements collected in the solid manure.

In housing systems producing only solid manure, quantities per cow per year (at 365 days housing period) are 18 t in Switzerland, 18 to 21.5 t in Germany (depending on source of information) and 32 t in Sweden. Only part of this

difference can be explained by the higher milk-yield and the higher amount of straw used in Sweden. A possible further source of difference is that animals are also housed for part of the day during the "non-housing" period, without this being accounted for in the questionnaire.

For non-dairy cows and young breeding cattle solid manure quantities vary between 1.6 and 18 t or, standardised at 365 days housing period, 3.2-18 t per animal per year. Comparisons are difficult because of the variable weight of the animals. In general, relations between countries and between housing systems are similar to those for dairy cows.

For beef cattle solid manure production per animal per year (standardised at 365 days housing period) varies between 4 and 15 t. Only for the UK are estimates for different age groups given. The variability is probably due to the production system (e.g. 500 kg end weight: CH with 14 months, UK with >2 years) and to different housing systems. If housing systems producing only solid manure are compared, production per animal per year varies between 7 t (CH, SF) and 14 t (S).

#### Pigs

For sows (including piglets) values for solid manure production vary between 2.7 (CH, No) and 3.7 t year<sup>-1</sup> (UK, D) for solid manure-only systems and from 2 (SF) to 4.7 t year<sup>-1</sup> (S) for other systems. For fattening pigs quantities per place per year mostly vary between 0.8 (S, A) and 1.6 t (UK, CH, D, I, S). Exceptions are values for Bulgaria (3 t), a system with wood shavings in Italy (0.6 t) and a sawdust-compost system (manure accumulated over 1 year) Finland (0.25 t). Differentiated estimates for four animal categories are given for the UK (weaners 0.45 t, "growers" 0.97 t, "cutters" 1.48 t, "bacon" 1.62 t).

#### Poultry

For hens a solid manure production of 0.02 to 0.04 t per animal place per year is reported from most countries. Exceptions are 0.014 t in Bulgaria, 0.048 t in Portugal and 0.065 t in Austria. In most cases differences can be explained by the housing system: deep pit systems which accumulate the manure over a longer time period being higher than belt systems. For broilers values given vary between 0.006 and 0.015 t per animal place per year (exception: P 0.044 t), for turkeys between 0.03 and 0.057 t, if a mean value between males and females is assumed for the UK.

### **3.4. Solid manure content**

For the nutrient content of solid manures nearly all countries reported a system of guide values used by extension services and farmers. These values are based mainly on analysis results from a larger number of samples. From Switzerland and Germany they are reported to be the results of analysis results and balance calculation on animal excreta with standard rations (combined with manure production values).

From the UK, Switzerland, the Netherlands, Germany, Northern Ireland, Belgium, Portugal, Austria, the Czech Republic and Bulgaria phosphorus and potassium contents were reported in P<sub>2</sub>O<sub>5</sub> and K<sub>2</sub>O, from Sweden, Norway, Finland and Italy in P and K. Content values were mostly given per unit fresh material. As a control the



content per unit dry matter was also calculated. Nevertheless, the variability between countries was hardly lower for the content per unit dry matter.

In many countries contents are given for less animal categories than manure production; probably because it is often difficult to make a clear distinction between categories under farm conditions and because contents will also vary within a certain range. Because of the limited number of categories and often limited information which contents match which housing system, only the range and mean values reported are presented in table 1 (more detailed information can be provided by H. Menzi). Within animal species no further differentiation is made. If only ranges were reported, the central value of the range was used in mean value calculations. For all animal categories ranges between values from different countries are considerable. This demonstrates that it is rather unsatisfactory simply to compare manure contents in different countries without better knowledge about feeding practices, housing systems, slurry produced together with the solid manure etc.

#### Cattle

With one exception (suckling cows in Finland) the reported dry matter content of solid manure is between 16 and 30%, with an average value of 22%. The organic matter content is between 63 and 90% of the dry matter. For most countries the  $P_2O_5$  content reported is around  $3 \text{ kg t}^{-1}$ , the  $K_2O$  content around  $7 \text{ kg t}^{-1}$ . The total nitrogen content reported shows a wide variability between 2 and  $7.7 \text{ kg t}^{-1}$ , with a mean value of  $4.8 \text{ kg t}^{-1}$ . The information concerning plant available nitrogen is given in different forms: some countries give values without definition how they are derived, others differentiate between mineral ( $N_{\text{min}}$  or  $N_{\text{NH}_4}$ ) and organic N ( $N_{\text{org}}$ ). If  $N_{\text{min}}$  is assumed to be equivalent to plant available N, plant available N reported varies between 0.5 and  $2\text{-}3 \text{ kg t}^{-1}$  with a mean value  $1.3 \text{ kg t}^{-1}$  or 26% of  $N_{\text{total}}$ . The highest values are reported from Switzerland, where plant available N is defined as N which becomes available within two years under optimal conditions and thus is always higher than the mineral N content at the time of spreading. Low values (10%) are especially used in the UK and for loose housing dairy systems in Belgium.

#### Horses, sheep and goats

According to the information received from seven countries horse manure typically has a dry matter content around 30 %, a  $N_{\text{total}}$  content around  $6 \text{ kg t}^{-1}$  and a  $P_2O_5$  and  $K_2O$  and plant available N content similar to that of cattle manure. Sheep and goat manure generally has a higher nutrient content than horse manure.

#### Pigs

No differentiation between solid manure from sows or fatteners was reported. Pig manure typically has a dry matter content between 20 and 25%. Its N and  $P_2O_5$  content is higher than that of cattle manure. In most countries the proportion of  $N_{\text{total}}$  being plant available is similar as for cattle. Again Switzerland has the highest and the UK the lowest values of plant available N.

		DM %	N <sub>total</sub> kg/t	N plant available		P <sub>2</sub> O <sub>5</sub> kg/t	K <sub>2</sub> O kg/t	Mg kg/t
				kg/t	% of N <sub>total</sub>			
Cattle	range	16-43	2-7.7	0.5-2.5	9-50	1.0-3.9	1.4-8.8	0.7-2.1
	average	22.3	4.8	1.3	26	3.0	5.7	1.1
Horses	range	25-54	5-8.2	0.4-2.1	25-33	1.8-3.2	2.0-9.0	0.8-1.8
	average	32.1	6.1	1.5	28	2.7	5.9	1.2
sheep, goats	range	25-48	6.1-8.6	1.3-2.6	23-31	2.3-5.2	5.7-16	1.1-3.5
	average	30.6	7.8	2.0	26	4.0	9.9	2.1
pigs	range	20-30	4-9	0.7-6	10-50	1.9-9.2	2.5-7.2	0.5-2.5
	average	23.8	6.8	2.4	26	6.3	4.9	1.4
hens	range	22-55	13-45	5.1-25	37-60	8-27	6-15	1.2-6
	average	40.6	23.6	10.9	49	16.6	10.7	3.1
broilers	range	45-85	18-40	2.0-15	24-50	6.9-25	6.7-23	2.5-6.5
	average	60.3	30.0	7.6	34	18.5	17.1	4.2
turkeys	range	54-65	20-33	4.0-16	17.5-50	17-25	6.0-21	2.4-6.3
	average	55.9	24.5	8.0	30	19.9	16.2	3.9

*Table 1*

*Range and average values reported for the nutrient content of solid manure from different animal categories.*

### Poultry

As expected, poultry manure in all countries has a considerably higher nutrient content than cattle or pig solid manure. For broilers and turkeys there is generally good agreement between values from different countries as well as between the two animal types: average values of 55-60% DM, 23-30 kg t<sup>-1</sup> N<sub>total</sub>, 19 kg t<sup>-1</sup> P<sub>2</sub>O<sub>5</sub> and 17 kg t<sup>-1</sup> K<sub>2</sub>O. For hens the variability is much greater because belt and deep pit systems cannot always be differentiated. In general, solid manure from laying hens has a somewhat lower content than that of broilers or turkeys. With average values between 30 and 50% the proportion of N<sub>total</sub> assumed to be plant available is notably higher in most countries than for cattle and pig solid manure.

### Heavy metal content

Only the UK and Switzerland reported about the heavy metal content of solid manure (table 2). The data from the two countries generally agrees well except for somewhat higher copper and cadmium contents of pig and poultry manure in the UK. For copper, these differences can be explained by known differences in the feed content, for cadmium the reason was not yet investigated.

animal type	copper (Cu) µg g <sup>-1</sup> DM		zinc (Zn) µg g <sup>-1</sup> DM		cadmium (Cd) µg g <sup>-1</sup> DM		lead (Pb) µg g <sup>-1</sup> DM	
	CH	UK	CH	UK	CH	UK	CH	UK
dairy cows	23.9	31.4	118	145	0.17	0.42	3.8	2.2
beef cattle	22.0	15.6	91	63	0.15	0.14	2.8	1.4
pigs	66.2	346.0	375	387	0.12	0.68	2.6	2.8
broilers/turkeys	43.8	92.4	349	403	0.29	0.38	2.9	2.9
laying hens	35.2	65.6	425	423	0.31	1.03	2.2	9.8

Table 2

*Copper, zinc, cadmium and lead content per unit dry matter (DM) of solid manure produced by different animal types in Switzerland (CH) and the United Kingdom (UK).*

### 3.5. Solid manure use

#### Crop

Data about solid manure use is available in greatly varying detail. Detailed survey results were reported from Switzerland, Sweden and Finland. Apparently, there is a tendency for solid manure to be used on arable crops in regions where this is possible: UK about 70 % of cattle solid manure and 90% of pig and poultry solid manure, Sweden and Finland about 80%, Switzerland 50%. The main arable crops receiving solid manure in most countries are potatoes and sugar beet. It is also often used on maize in Switzerland, Italy, Austria and the Czech Republic, on cereals in Scandinavian countries and Italy and on oilseed in Norway, Sweden and the Czech Republic. Considerable use of solid manure on grassland is reported from Switzerland (50%; in hill and mountain areas), Austria, Scandinavian countries, the Netherlands (except organic farms), the UK (30% of cattle and 10% of pig and poultry solid manure), Norway and for cattle solid manure in Germany and Italy.

#### Application time

Spring is the most important application time of solid manure in most countries. Only in the Czech Republic autumn application is most important. Detailed figures received are: S 60% in spring, 40% in autumn, SF 35-60% in spring 20-50 in autumn, CH 50% in spring, 15 % in summer and 20 % in each in autumn and winter. Winter spreading is reported to have stopped almost completely in Finland during the past years. No reports on this topic were received from other countries.

#### Application rate

The UK, the Netherlands, Belgium and Austria report cattle and pig solid manure to be used at rates of 20-40 t ha<sup>-1</sup>. Higher rates were reported from Norway (40-60 t ha<sup>-1</sup>), Italy (40-60 t ha<sup>-1</sup>), Finland (average in a 1986 survey 38 t ha<sup>-1</sup> and in Southern Finland in 1995 44 t ha<sup>-1</sup>) and Bulgaria (20-150 t ha<sup>-1</sup>, typical 20-60 t ha<sup>-1</sup>). Lower rates were reported for grassland in Switzerland (10-30 t ha<sup>-1</sup>), from Germany (20-30 t ha<sup>-1</sup>) and from Northern Ireland (20 t ha<sup>-1</sup>). In Switzerland (and one report from Germany) recommendations enclose wider ranges to allow a better

adjustment to prevailing conditions: e.g. 10-40 t ha<sup>-1</sup> on cereals and rape seed and 10-50 t ha<sup>-1</sup> for potatoes and beet. It is interesting to compare these recommendations with actual amounts applied according to a survey on over 100 Swiss farms during the years 1991-96 (about 400-600 ha each year receiving solid manure). The average rate over all crops decreased from 25.6 t ha<sup>-1</sup> in 1991 to 17.2 t ha<sup>-1</sup> in 1996. Average rates for different crops were 14 t ha<sup>-1</sup> on leys, 20 t ha<sup>-1</sup> on maize, 16 t ha<sup>-1</sup> on winter wheat, 19 t ha<sup>-1</sup> on winter barley, 25 t ha<sup>-1</sup> on potatoes and 21 t ha<sup>-1</sup> on beet. Thus, the mean rate actually applied on these farms was always at the lower end of the recommended range and rates clearly decreased in recent years. This can be mainly attributed to a new ecological subsidies programme limiting the amount of nitrogen and phosphate used in fertiliser inputs which was introduced in 1994 and in which over 80% of the farms now participate (1998).

#### Application technique

Few details are given about the spreading equipment in most countries. In Switzerland rear discharge manure spreaders are most common, in the UK side discharge spreaders. In Switzerland, side discharge systems are used primarily in mountain areas, because they allow the application of low rates (down to below 10 t ha<sup>-1</sup>, important for solid manure use on extensively managed grassland) and can be used to spread manure in hilly terrain up to 10 m wide from the roadside. From Sweden side discharge systems are also reported to be used for manure from solid manure-only housing systems. For "semi-liquid manure", a manure containing all dung and 50% of the urine, special systems with "rollers instead of rippers" are reported. Hand spreading was reported for most solid manure in Bulgaria, about 12% in Finland and on some alpine pastures and small mountain farms in Switzerland.

Rapid incorporation (within one day) is reported only from Sweden (73% of the farms), from Bulgaria and on a smaller scale from the UK. In most other countries no special attention is given to this point and the solid manure is usually incorporated after some days in the course of ploughing or harrowing.

### **3.6. Nitrogen losses from solid manure**

The reports about N-losses from solid manure in animal houses, during storage and after application were in variable detail. This information is summarised in table 3; direct comparison of the data is not easy because of the variable basis, units and categories used.

In cattle houses there is obviously a clear difference between tied and loose housing systems, but the greatest difference can be observed for poultry. This is probably due to very different housing systems as well as to uncertainties about ammonia and other N-losses.

For storage losses the information received can be divided into two groups: NL,S, No, SF, Bu with N-losses around 20% of N<sub>total</sub> and UK and CH with ammonia (or gaseous) losses of 3-5% of N<sub>total</sub> for cattle solid manure. These differences probably arise because the figures for the first group take into account total N-losses including those in seepage water while the second group gives only gaseous losses

because it is assumed that seepage water from the solid manure store should be collected in the slurry and thus, is not lost.

For application losses, countries can be grouped in to two groups, The UK, Switzerland and the Netherlands with losses of 60-70 % of the total ammoniacal nitrogen (TAN) applied and the other countries with losses of generally below 20% of total nitrogen applied. Depending on the TAN-content assumed, the two groups might be quite comparable. Assuming a TAN-content of 10-20% of  $N_{total}$ , the approximately 65% of TAN losses reported by the UK, CH and NL would be equivalent to 7-13 % of  $N_{total}$ . Actual measurements of ammonia emissions from solid manure application are only reported from Switzerland and the UK.

	UK	CH	NL	D	S	No	SF	P	CR	Bu	A
<b>houses</b>	kg N per 550 kg LW	% of $N_{total}$									g LU <sup>-1</sup> day <sup>-1</sup>
cows (tied stall)		7%		<5%		6%	3-6%		6.5%	5-10%	5.8 NH <sub>3</sub> , 0.62 N <sub>2</sub> O
cows (loose h.)	5.3 kg	15%		25-50%	20%						
beef cattle	7.08 kg	15%									
pigs	22.2 kg	15%			25%	13%	6-12%				
hens (belt syst.)		60%				7%	5-10%				
hens (deep pit)		20%									
broilers	21.6 kg	20%									
<b>storage</b>	g N m <sup>-2</sup> d <sup>-1</sup>	% of $N_{stock}$	% of $N_{total}$								g LU <sup>-1</sup> year <sup>-1</sup>
Cows	2 g	30%	dep. Duration	25-50%	25%	20%	18-23%		dung 5.8% dungwater 13.5% total 19.3%	35%	stacked: 1040 NH <sub>3</sub> , 1315 N <sub>2</sub> O composited: 6710 NH <sub>3</sub> , 341 N <sub>2</sub> O
beef cattle	0.91 g	30%	2 m. 10-14%	25-50%	25%	20%					
pigs	2 g	30%	4 m. 16-19%	25-50%	25%	20%	17-22%	up to 80%			
poultry	5.5 g	20%	6 m. 21-23%	25-50%	25%	9%	9%				
<b>applicati on</b>	% of TAN applied			% of $N_{total}$	% of N	% of $N_{total}$				g LU <sup>-1</sup> year <sup>-1</sup>	
cattle	65%	60-70%	60%	<5%	5-50% dep. On season, crop,	15-20%	2-18%		dung 6.8% dungwater 3.0% total 9.8%	5-10%	stacked: 1970 NH <sub>3</sub> , 0 N <sub>2</sub> O composited: 0 NH <sub>3</sub> , 0 N <sub>2</sub> O
pigs	65%	60-70%	60%	<5%	incorp.	15-20%	2-18%				
hens		25%	60%	<5%		15-20%	2-24%				
broilers	35%	25%	60%	<5%		15-20%					

Table 3:

Nitrogen losses from solid manure in animal houses, storage and after application as reported from different European countries. (UK-United Kingdom, CH - Switzerland, NL - Netherlands, D - Germany, S - Sweden, No - Norway, SF - Finland, P - Portugal, CR - Czech Republic, Bu - Bulgaria)

If approximate average values from table 3 are used to calculate total N-losses from cattle solid manure management, these can be estimated at 20-40% of  $N_{total}$ . Only from Austria specific information was reported on  $N_2O$  emissions and on differences in emissions between stacked and composted solid manure. These experimental results show that total gaseous nitrogen losses during storage and after application are about 60% higher for composted than for stacked solid manure (5736 and 3313 g N LU<sup>-1</sup> year<sup>-1</sup> respectively), but  $N_2O$  emissions are nearly four times as high for stacked than for composted solid manure.

### 3.7. Other storage losses

To the question of losses other than nitrogen responses were received only from Switzerland, Sweden, Norway, the Czech Republic and Bulgaria (table 4). In CH, S and N it is assumed that no losses of  $P_2O_5$ ,  $K_2O$ , Mg and Ca occur because any seeping losses should be collected in the slurry. In the CR and Bu losses from the solid manure are at least partly counted as actual losses. Losses of total matter are assumed to be at least 25%, dry matter losses at 10 to 30%.

	FM	DM	OM	N	$P_2O_5$	$K_2O$	Mg	Ca
Switzerland: loss in SM (%)	25	10		25	5	15	5	5
of this collected in slurry (%)	25	25		50	100	100	100	100
Sweden source 1)			10-20		insignificant			
source 2)	25-50		25-50					
Norway	29	15			0	0	0	
Austria stacked SM		35		7.5				
composted SM		60		11				
Czech Republic			30-40 and more		dung 10% dungwater 3.6% total 13.6%	dung 8.4% dungwater 14% total 22.4%		
Bulgaria	20-30%; 15-20% collected in slurry if tank available							

Table 4

Losses during storage of solid manure as reported from Switzerland (CH), Sweden (two reports received) and Norway. (FM - fresh matter, DM - dry matter, OM - organic matter, N - nitrogen,  $P_2O_5$  - phosphate,  $K_2O$  - potash, Mg - magnesium, Ca - calcium)

### **3.8. Solid manure "exported" from agriculture**

Apparently, solid manure export from agriculture is of small importance all over Europe. Reported most often is the combustion of poultry, horse or sheep/goat manure (UK, S, I, P, Bu), the use in horticulture (D, SF, S, Bu), the use for mushroom production (CH, NI) and fertiliser production (mainly poultry manure; I, B, NL?, CH). In Portugal poultry manure is also used in animal feed. Even though the information received is not sufficient to the amount of solid manure leaving agriculture, it appears that this "export" is most important in Portugal (20% of sheep and goat manure; sheep and goats are the most important animal category in this country) and the UK (today 340'000 t, later possibly 500'000 t year<sup>-1</sup>; this is approximately 15-20% of the broiler and turkey manure produced).

### **3.9. Regulations, laws, recommendations**

As national legislation can vary in structure and approach and because the questionnaire was organised such that experts could mention legislation and recommendations they judged relevant rather than filling in how specific aspects are treated, this survey can not give a comprehensive overview on the topic. Nevertheless, the results summarised in table 5 can show different interesting aspects :

- Only Portugal and Bulgaria reported that so far there was no legislation with direct impact on solid manure management. Nevertheless, the reports from most countries show clearly that solid manure is much less governed by legislation than slurry management.
- Many countries report about water protection legislation giving guidance for solid manure management. This demonstrates that as for manure in general water protection is the major legislative concern regarding manure management.
- From five countries it was reported that a code of good agricultural practice gives guidance to farmers concerning environmentally friendly manure and nutrient management. It can be assumed that other countries have similar recommendations.
- Switzerland, the Netherlands and Finland appear to have the strongest control on the nutrient and manure management. These countries not only have restrictions about manure application in winter and the maximum application rate, but also clear limits concerning the nutrient balance. In Switzerland and Finland these restrictions are made in the framework of ecological subsidies. In both countries over 80% of the farmers participate in these voluntary programs.
- Only from Switzerland are animal welfare regulations reported to have a strong influence on housing types. Nevertheless, reports concerning the growing importance of solid manure systems (chapter 3.1) indicate that this is or shortly will be the case in other countries too.
- Restrictions concerning solid manure stores near farm building (mainly collection of seepage water) are only reported from the UK, Switzerland and Italy. Minimum storage capacity for solid manure is only prescribed in Sweden and for new buildings in Switzerland.

- Nowhere, at present, is the storage of solid manure in field heaps regulated.
- An obligation to rapidly incorporate solid manure exists only for winter application (December-February) in Sweden.
- Only the UK reports odour regulations concerning solid manure. In Switzerland similar recommendations exist for new animal houses and manure stores.

	UK	CH	NL	D	S	SF	I	B	A	NI
Water Pollution		X		x		x		x	x	x
Code of good practice	x	X			x			x	x	x
Nutrient balance		X	x			x			x	
Application rate		X	x			x	x		x	
Application time		X	x		x	x	x			
Housing systems, animal welfare		X								
Storage near buildings	x	X					x			
Storage capacity		X			x					
Storage in field heaps										
Incorporation					x					
Odour	x	X								

Table 5

*Overview of subjects concerning solid manure treated in laws and regulations in different European countries. (UK - United Kingdom, CH - Switzerland, NL - Netherlands, D - Germany, S - Sweden, NI - Northern Ireland, SF - Finland, I - Italy, B - Belgium, CR - Czech Republic).*

### 3.10. Ongoing research

Because the information concerning ongoing research projects and recent scientific publications on solid manure was variable in detail and because the RAMIRAN-conference in Rennes in May 1998 demonstrated that research on solid manure and other organic solids used as fertiliser is rapidly gaining in importance in different countries, a more detailed survey on this topic will be made by the members of the Working Group on Solid Manure.

## 4. Conclusions

This survey can certainly not claim to give a comprehensive picture of solid manure management all over Europe. If such a task were actually possible, it would require a much greater input than possible for this survey. It could only be done in the framework of a network of several experts from every European country. Nevertheless, the results of this survey, in spite of the remaining gaps and uncertainties, can be a valuable aid for national experts to see how their solid manure management compares to that in other countries and to promote awareness about gaps in knowledge and the potential for improvement.

The first step necessary for a more comprehensive overview of (solid) manure management in Europe would be the establishment of common definitions and terms for housing systems, manure types, farming systems etc.. This will probably



require a close collaboration of experts from as many countries as possible and/or somebody visiting farms in every country and major region to draw up a comprehensive description of systems used in a standardised common terminology.

Even more than for slurry, solid manure management varies considerably over Europe due to differences in natural conditions, farm structure, tradition, policy etc.. The scientific understanding and characterisation of solid manure systems is considerable, especially in central and northern European countries. Nevertheless, there remain serious gaps both in knowledge and technology which are greater than for slurry, for example concerning factors controlling solid manure composition, nutrient availability of solid manure (especially for N), long term efficiency of the nutrient cycle in solid manure farming systems, possibilities for a better control of solid manure quality, practical difficulties in achieving even and accurate spreading of solid manures (particularly important for poultry manures), ecological impacts of solid manure management etc.

Concerted efforts on solid manure by experts from as many countries as possible could be very beneficial for all the participants as well as for policy makers and extension services all over Europe. The Working Group on Solid Manure of RAMIRAN and the EU-Concerted Action "Recycling Organic Solids in Agriculture" can be a good framework for such efforts. Nevertheless, solid manure systems are so complex that the understanding about them will always remain partial and that considerable regional differences will remain.

## **5. Acknowledgements**

This survey was possible only thanks to the considerable efforts of the experts in the different countries that collected the information and filled out the questionnaire. Many thanks therefore to T. Amon, J.C.W. Boxberger (Austria); M. Frankinet, J.P. Destain (Belgium); V. Koutev (Bulgaria); J. Klir (Czech Republic); P. Kapuinen (Finland); H.J. Ahlgrimm, J. Hahne, D. Hesse, T. Hinz, F. Schuchardt, G. Steffens (Germany); G. Bonazzi, U. Chiappini, R. Chiumenti (Italy); J.J. Schröder (Netherlands); E.J. Stevensen (Northern Ireland); J. Morken (Norway); C. M.d.S. Cordovil (Portugal); D. Hagerberg, G. Carlson, L. Rodhe (Sweden); H. Menzi, A. Uebersax, U. Walther (Switzerland); B. Pain, K. Smith, A. Brewer, N. Nicholson (United Kingdom) and all the others that indirectly contributed information.



# **Report of an enquiry of Network members into the status of metals in animal manures.**

*Rapport à la demande des membres du réseau RAMIRAN  
sur l'état des métaux lourds contenus dans les déjections animales.*

**R J Unwin**

Group Chairman

FRCA MAFF, Nobel House, 17 Smith Square.SW1 3 JR. London. UK.

E-mail : [R.J.Unwin@frca.maff.gov.uk](mailto:R.J.Unwin@frca.maff.gov.uk)

## **Abstract**

At the meeting of the Network held in Gödöllő in October 1996, it was agreed each Expert Group should seek to produce a report of the status of knowledge in their area of interest. A questionnaire concerning metals in animal manures was sent to a member of the Network in each country with a request to seek co-operation from other colleagues if they did not have the necessary expertise. This approach produced responses from six countries - Germany, Finland, Italy, Belgium, Switzerland and the United Kingdom. However this does provide a wide geographic coverage and the consistency of the results enables a surprisingly clear picture to be drawn.

## **Résumé**

Lors de la dernière rencontre du réseau qui s'était tenue à Gödöllő en octobre 1996, il a été décidé que chaque groupe d'experts devrait produire un rapport sur l'état des connaissances dans son domaine.

Un questionnaire concernant la teneur en métaux lourds présents dans les déjections animales fut transmis à chaque membre du réseau RAMIRAN dans chaque pays. Cette démarche n'a conduit qu'à 6 réponses de six pays : Allemagne, Finlande, Italie, Belgique, Suisse et Royaume-Uni. Cependant, de façon surprenante, le dépouillement de ces informations conduit à la fois à une couverture géographique importante et à des conclusions relativement explicites.

## **Format of questionnaire**

Members were asked for details of:

- legal controls or official guidance that either directly or indirectly limits the accumulation in soil of metals from animal manures.
- detailed information on actual rates of manure application, background soil metal content and observed problems due to accumulations of metals from manures.
- metal contents of manures and slurries from the main classes of livestock.
- legal limits for metals in feedingstuffs and any data on actual metal content of livestock feeds.

## **Results**

### **Controls on metal additions**

None of the countries currently have general legal limits for directly controlling metals although all have indirect controls through limits on nitrogen and/or phosphorus applications, in at least part of their territories. In addition to incomplete coverage for legal nutrient controls, Italy and the UK have general national guidance concerning nitrogen. (Within the EU the Nitrate Directive requires at least such indirect guidance to be put in place through a general Code of Good Agricultural Practice.) In Italy and Finland there are some minor legal controls relating respectively to processed manures offered for sale and manures imported to ecological (organic) farms.

In the UK direct non-statutory guidance to control metals is given in the Code of Good Agricultural Practice for the Protection of Soil. This recommends that metals from manures should not accumulate beyond the limits that apply for sewage sludge. Returns from each country are summarised in Table 1.

### **Rates of manure application**

Of the respondent countries nobody currently has detailed information on actual field rates of application although some EU states would have such information where more strict controls are exercised on nutrient applications. The UK is working towards such information by linking data on stock numbers and available land area for spreading. Table 2.

## Metal content of soils

All countries had data on background metal contents although in Italy this is more limited than the other three. Nobody appears to have looked specifically at the metal contents on land associated with intensive livestock enterprises. Network members were unaware of adverse effects attributed to metals in practical situations. There is at least one old report in the literature of copper from pig slurry effecting earthworms in The Netherlands and a personal communication to the author has claimed zinc from pig manure has affected maize production on sandy soils in a part of Germany. Table 2.

## Metal content of manures and slurries

The number of samples involved in each of the studies for which data was submitted was small. Some indicated a large range of values but no statistical interpretation was provided. Differences between countries for the major metals zinc and copper, were usually explained by legal differences in allowed metal supplementation of feeds (see below). Care also has to be taken in interpretation of the data because of, sampling errors, metal contents that vary with the age of stock and mixing of manures on farms of stock of different ages. Problems may also arise due to the definitions used for different classes of manures. The results suggest that what the UK reported as pig farmyard manure with large straw addition in Germany and Switzerland at least may have been largely undiluted faeces. Returns are tabulated in Tables 3, 4 and 5.

## Zinc and copper

### Pig manures and slurries

There were few results specifically for young pigs but those there were, confirm an elevated zinc content in weaner slurries presumable due to supplying zinc oxide as a veterinary medicine. Actual values from Germany and Italy were not as high as estimated figures from the UK. Further work to clarify zinc excretion by such young piglets is indicated.

In all countries fattening pigs of mixed age are producing slurries with 600-1000 mg/kg zinc and in EU States copper 300 - 600 according to the permitted level of copper supplementation. In Switzerland where supplementation as a growth promoter is not permitted values are lower.

### Poultry manures

The metal content of poultry manures is very consistent. Between 350-450 mg/kg Zn in all countries and copper in the range 40-100 mg/kg.

## Cattle manures

Apart from Italy where zinc in both beef and dairy slurry is nearly twice that reported elsewhere values are also fairly consistent, somewhat over 200 mg/kg Zn and around 50 mg/kg copper in dairy slurry with slightly less zinc in beef manures. Values in Switzerland were rather lower than this. Concentrations in farmyard manures were on the whole similar to those in slurries.

## Nickel

Apart from values of over 30 mg/kg nickel in some pig slurries, values for this metal was less than 12 mg/kg in manures from all other classes of stock.

## Lead

All lead contents were less 11 mg/kg apart from weaner slurry in Germany (17.6 mg/kg). This was the only report of lead for this class of stock and may be associated with the high zinc content. Lead and cadmium values in Swiss manures were generally lower than elsewhere. However with a recent move away from using bone meal as the main phosphorus supplement to mineral materials in the wake of the BSE situation these are thought likely to have risen since the survey was undertaken.

## Cadmium

Only German weaner slurry (1.5) and UK layer manure (1.1) showed cadmium values above 1 mg/kg.

## Arsenic

Only the UK reported arsenic values and these varied from 1.7 mg/kg in pig slurry to 9 mg/kg in poultry manures.

## Mercury

Mercury data was provided from Finland and the UK. Apart from Finnish pig slurry at 0.21 mg/kg all values were less 0.07 mg/kg.

## Chromium

Chromium data was reported Germany and the UK with values from 1 to 20 mg/kg.

## Metal limits in animal feedingstuffs

All the EU respondents are subject to Community legislation on this topic both in terms of maximum concentrations of contaminants such as lead and cadmium and

of additives such as zinc and copper. The returns reflect this commonality although information was not provided from Finland.

The only significant variation between countries concerns zinc and copper and relates to the UK where because of overall stocking rates a derogation for a higher addition of copper for fattening pigs over 16 weeks of age is still in operation. Table 6.

The Commission has signalled their intention to review the allowed metal contents of animal feedingstuffs and have called for nominations to form an expert group to look into the topic.

#### **Actual metal content of feedingstuffs**

It was hoped to gather actual data on metals in complete diets fed to stock in order to compare with the manure metal information. Only the UK was able to provide such information and it is summarised in table 6. This information was discussed at the last meeting of the Network and has been used subsequently to estimate metal concentrations in manures. Research described elsewhere at this meeting by Chambers et al seeks to confirm the relationship between metal intake and rates of excretion.

Of concern is the fact that whilst all the zinc contents are well within legal limits some are higher than recommended as best practice for necessary mineral supplementation for particular classes of stock. The commonality in manure metal contents reported above suggests there may be a similar situation in other countries represented in the Network.

## **Conclusions**

1. Although the data set is incomplete it provides a useful overall picture of the status of metals from animal manures in the countries of the Network.
2. Legal controls on nutrient (nitrogen and phosphorus) operating through the Nitrate Directive, Agri-Environment Schemes and National laws provide indirect control on metal accumulations but geographical coverage is not complete and non-statutory guidance alone will continue to operate in some countries.
3. The implementation of the Integrated Pollution Prevention and Control Directive in the EU will include intensive pig and poultry units and thus further controls on metal accumulations will be possible in future.
4. This study has not revealed any information on the accumulation of metals that may have already occurred in soils receiving large applications of manure in recent

years. General surveys of background soil metal concentrations have not been of sufficient scale to identify areas of high stock density.

5. The metal contents of manures are similar in different countries and indicate a commonality of feeding practices.

6. The allowable metal content of feedingstuffs, both of contaminants and supplements is the subject of current consideration in the Commission. The reasons for the current levels of supplementation should be re-examined so that all unnecessary additions of metal are removed from the system.

7. There appears to be a major gap in knowledge concerning the actual metal content of animal feeds which would be the easiest way of identifying the load returned to land in manures.



	Do you have legal controls that directly limit metal from manures ?	Do you have guidance aimed to limit metal from manures ?	Do you have legal controls that in-directly limit metal from manures ? (EC Nitrate Directive not included)	Do you have guidance that in-directly limit metal from manures ?
Germany	No . (n.b. proposed Soil Act may have maximum soil metal limits for types of agricultural production)	No	Yes. Various national and regional limits on rates of nutrients	No
Italy	Only for fertilisers for sale produced from manures.	No	National limit for slurry from stock of 4t/LW equated to total N rate. Lower Regional limits down to 170 N in vulnerable areas	Yes N limits in certain Regions
Finland	Only for importation to Ecological farms	No	Limit of 1.5 LU/ha in some areas. Maximum N and P rates under Agri-Environment prog.	No
Belgium	No	No	Yes. Various national and regional limits on rates of nutrients	No
Switzerland	No	?	Yes	Yes
United Kingdom	No	Code of Good Agricultural Practice recommends using same limits as Sewage Sludge Regulations to monitor increases	Limits on manure N in Agri-Environment prog., e.g. 250 kg/ha N in Nitrate Sensitive Areas	Code of Good Agricultural Practice recommends limiting manure N to 250 kg/ha per year or less

*Table 1  
Controls on metal additions to soil in animal manures*

	Do you have information on actual rates of manure application? (Not including data on stock numbers on a Regional basis)	Do you have information on background concentrations of heavy metals in agricultural soil	Do you have comparable data for intensive livestock farms and other units? (Not including experimental monitoring of small areas?)	Has the accumulation of metals from animal manures caused substantiated significant adverse effects?
Germany	No	Yes. Numerous and extensive surveys have been undertaken	No	No? (Contrary information received from UBA re zinc from pig slurry)
Italy	For pig slurry in some Regions	Only in limited data from certain Regions	No	No
Finland	No	Yes. Survey of 2000 fields resampled after 13 years	No	No
Belgium	Yes in some Regions		No	No
Switzerland	No	Yes	No	No
United Kingdom	Studies to be completed will provide data linking stock and total available land.	5 km grid survey of whole country. Also survey of fields randomly selected each year.	No	No

*Table 2  
Rates of manure application and soil metal concentration*

	Dry Matter	Zinc	Copper	Nickel	Lead	Cadmium	Arsenic	Chromium	Mercury
<b>Pig Slurry. Mixed ages</b>									
Germany (Mean of 3 studies)		1081	492	32.5	10	0.75		12.5	
Italy	3.7	800	525						
Finland		636	305		2.7	0.25			0.21
Belgium	7.3	811	440	15	8	0.9		8	0.2
Switzerland		746	115		1.8	0.2			
United Kingdom (Survey)	4.4	575	351	10.4	2.5	0.3	1.7	2.8	0.008
(Estimated)	6.0	1233	887	11.7	3.2	0.5		4.8	
<b>Pig slurry. Weaners</b>									
Germany	4	2410	1386		17.6	1.5			
Italy		2400							
United Kingdom (Estimated)		Max. 12,000							
<b>Pig Farm Yard Manure</b>									
Germany		1220	740	13		0.43		11.0	
Italy		640	540						
Finland		420	134		3.7	0.22			
United Kingdom (Survey)	21.7	431	374	7.5	2.9	0.37	0.86	2.0	0.008
(Estimated)	20.0	340	230	3.5	4.0	0.25		1.1	

**Table 3**  
**Metal content of pig manures mg/kg DM**

	Dry Matter	Zinc	Copper	Nickel	Lead	Cadmium	Arsenic	Chromium	Mercury
<b>Broiler Litter</b>									
Germany (Mean of 2 study)		430	63	9	6	0.2		3.8	
Finland		346	64		11.5	0.16			0.07
Belgium		270	93		< 5				<0.1
Switzerland		349	44		2.9	0.3			
United Kingdom (Survey)									
(Estimated)	59	378	97	5.4	3.6	0.4	9.0	17	
	49	398	102	7.2	1.6	0.5		6.0	.002
<b>Laying hens</b>									
Italy	22	440	85						
Belgium		648	93		<5				<0.1
Switzerland (deep pit)		511	44		2.2	0.2			
(belt system)		425	35		2.2	0.3			
United Kingdom (Survey)									
(Estimated)	41	459	65	7.1	8.4	1.1	9.0	17.2	
	40	437	67	7.5	6.7	1.0	0.35	4.2	0.02

**Table 4**  
**Metal content of poultry manures mg/kg DM**

	Dry Matter	Zinc	Copper	Nickel	Lead	Cadmium	Arsenic	Chromium	Mercury
<b>Cattle slurry. Dairy -(Mixed)</b>									
Germany(Mean of 3 study)		221	44	5.5	7.6	0.41		5.5	
Italy	13	450	55						
Finland		275	47		3.7	0.24			0.04
Belgium	5.6	284	92	7	11	0.6		7	
Switzerland		162	37		3.8	0.20			
United Kingdom (Survey) (Estimated)	7.6 7.6	209 212	62 56	3.7 7.5	3.6 8.7	0.38 0.37	1.44 2.75	0.91 7.0	0.04
<b>Cattle slurry. Beef</b>									
Germany (Bulls) (Calves)	10.1 1.0	187 410	29 76		10.7	0.55			
Italy	8.5	400	55						
Finland									
Switzerland		255	53		3.0	0.17			
United Kingdom (Survey) (Estimated)	12 10	133 170	33 45	6.4 6.0	7.1 7.0	0.26 0.30	2.6 2.2	4.7 5.6	0.03
<b>Cattle Farm Yard Manure. Dairy - Beef</b>									
Germany		213	39	10	7.0	0.44		20	
Italy									
Finland		197	33		2.5	0.23			0.06
Switzerland		118	24		3.8	0.17			
United Kingdom (Survey) (Estimated)	18.4 25	153 170	37 45	3.7 6.0	3.6 7.0	0.38 0.30	1.6 2.2	5.3 5.6	0.03

**Table 5**  
**Metal content of cattle manures mg/kg DM**

	Country	Zinc	Copper	Nickel	Lead	Cadmium	Arsenic	Mercury
Poultry /cattle	All ? Complete feed Mineral P	250	30-50		5 30	0.5 (1 cattle) 10	2 10	0.1
Pigs	All ? Complete feed Mineral P				5 30	0.5 10	2 10	0.1
Breeding	Germany Italy Finland United Kingdom	250 250 250	35					
Rearing 4-6 weeks	Germany Italy Finland United Kingdom	250 250 250	175* 175*					
6-16 weeks	Germany Italy Finland United Kingdom	250 250 250	175 175 175					
16+ weeks	Germany Italy Finland United Kingdom	250 250 250	35 35 100					

**Table 6**  
**Metal limits in feedingstuffs. mg/kg.**

	Dry Matter	Zinc	Copper	Nickel	Lead*	Cadmium	Arsenic	Chromium
<b>Pigs</b>								
Creep (4)	90	2820	188	2.3	1.0	0.18	0.36	0.35
Weaner (4)	88	834	167	2.3	1.0	0.13	0.42	0.81
Grower (5)	88	215	168	3.3	1.0	0.10	0.31	0.52
Finisher (7)	88	185	105	2.8	1.0	0.10	0.23	0.90
Breeding (6)	87	158	29	2.0	1.0	0.11	0.22	1.20
<b>Poultry</b>								
Broiler starter (2)	89	150	31	2.1	1.0	0.19	0.22	1.50
grower (4)	88	120	34	2.0	1.0	0.17	0.25	0.93
finisher (3)	88	130	31	1.2	1.0	0.15	0.15	0.20
Turkey starter (2)	85	145	20	1.5	1.0	0.16	0.23	2.14
grower (4)	87	124	27	2.0	1.0	0.15	0.27	1.04
finisher (3)	87	108	19	2.1	1.0	0.19	0.10	0.68
<b>Layers</b>								
Purchased (4)	89	103	13	1.9	1.0	0.39	0.10	0.67
Home mix (7)	90	72	13	1.9	2.1	0.20	0.10	0.61
<b>Cattle</b>								
Dairy concentrate	86	116	44	2.3	1.3	0.31	0.34	2.07
Beef	86	120	35	3.1	1.0	0.17	0.46	1.42

\* 1.0 mg/kg = limit of detection

*Table 7*  
*UK survey of metal content of animal feedingstuffs.*  
*(Median mg/kg DM in ( ) samples)*





## List of participants

Name	Title	Organisation	Address	Postcode	Town	Country
AMON Barbara	Ing	Institute Landtechnik,	Universitat F Bodenkultur, Nussdoreer Lande 29-31,	1190	Vienna	Austria
AMON Thomas	Dr	Institute Landtechnik,	Universitat F Bodenkultur, Nussdoreer Lande 29-31,	1190	Vienna	Austria
ARKHIPCHENKO Irina	Prof	Research Institute for Agricultural Microbiology	Podbelsky Shossee, 3,	189620	St Petersburg-Pushkin - 8	Russia
AUBERT Claude	Mr	ITAVI	Zoopôle Beaucemaine, BP 37,	22440	Ploufragan	France
AUDON Emmanuel	Mr	U.G.P.V.B.	104, rue E. Pottier, BP 6613,	35066	Rennes Cedex	France
BALSARI Paolo	Dr	Dipartimento di Economia Agraria, Forestale Ambientale	Universita Degli Studi di Torino, Via Leonardo da Vinci 44,	10095	Grugliasco - Torino	Italy
BELINE Fabrice	Mr	Cemagref	17, avenue de Cucillé,	35044	Rennes Cedex	France
BERNAL Maria-Pilar	Dr	Centro de Edafologia y Biologia Aplicada del Segura, CSIC	Avda de la Fama nº1,	30003	Murcia	Spain
BODET Jean-Marie	Mr	I.T.C.F.	Station Expérimentale de la Jaillière,	44370	Varades	France
BOHM Reinhard	Prof. Dr	Universität Hohenheim	Institute für Umwelt - Und Tierhygiene Sowie, Tiermedizin Mit Tierklinik,	D-70593	Stuttgart	Germany
BOUANANI Fatiha	Mme	Université de Provence. Laboratoire Chimie et Environnement	Case 29, 3 place Victor Hugo,	13331	Marseille Cedex 3	France
BREWER Alan	Mr	Farming and Rural Conservation Agency	FRCA, Nobel House, 17 Smith Square,	SW1P 3JR	London	United Kingdom
BRIANT André	Mr	La Fennetrie		37500	Marcay	France
BÜELNA Gerardo	Dr	Centre de Recherche Industrielle du Québec (CRIQ)	333, rue Franquet, Sainte-Foy,		Quebec	Canada
BURTON Colin	Mr	Silsoe Research Institute	Wrest Park, Silsoe,	MK45 4HS	Bedford	United Kingdom
CABRAL Fernanda	Dr	Instituto Superior Agronomia DQAA	TAPADA DA AJUDA,	P1399	Lisbon Codex	Portugal
CASEBOW Andrew	Dr	Agricultural and Environment Adviser	Bailiffs Cross, St. Andrews,	GY68RJ	Guernsey	United Kingdom
CAUPIN Henri-Jean	Mr	ELF ATOCHEM	La Défense 10, Cedex 42,	92091	Paris La Defense Cedex	France
CELAN Stefan	Ing	Institute Bistra Technologie Zentrum	Mestni Trg 1,	2250	Ptuj	Slovenia
CELLIER Pierre	Mr	I.N.R.A.	Station de Bioclimatologie,	78850	Thiverval Grignon	France

CHADWICK David	Dr	IGER	North Wyke, Okehampton,	EX20 2SB	Devon	United Kingdom
CHAMBERS Brian	Dr	ADAS Gleadthorpe Research Centre	Meden Vale, Mansfield,	NG20 9 PF	Nottinghamshire	United Kingdom
CHATAIGNER Jean	Mr		VERT,	07430	Vernosc Les Annonay	France
CHAUSSOD Remi	Dr	I.N.R.A.	17, rue de Sully, BV 1540,	21034	Dijon	France
CHEVERRY Claude	Prof	ENSA. INRA	Laboratoire de Science du Sol, 65, route de St Brieu,	35042	Rennes Cedex	France
CHRISTIE Peter	Dr	Department of Agriculture for Northern Ireland	Agricultural and Environmental Science Division, Newforge lane,	BT9 5PX	Belfast	United Kingdom
COOLS Danielle	Mrs	K.U. LEUVEN	Lab. of Soil Fertility and Soil Biology, Kardinaal Mercierlaan 92,	3001	Heverlee	Belgium
CORDOVIL Claudia	Mds	Instituto Superior Agronomia DQAA	TAPADA DA AJUDA,	P1399	Lisbon Codex	Portugal
COULOMB-VEUDEUVRE I.	Mme	SITA.	Technopôle CNPP. BP 2265, Route de la Chapelle Réanville,	27950	Saint Marcel	France
DA BORSO Francesco	Dr	Univ. of Udine - Italy	Via Delle Scienze, 208,	33100	Udine	Italy
DACH Jacek	Mgr. ing	Academy of Agriculture	Wojska Polskiego 50,	60-627	Poznan	Poland
DAVIS Robert	Dr	WRc plc	Henley Road, Medmenham, Marlow,	SL7 2HD	Bucks	United Kingdom
DE GUARDIA Amaury	Dr	Cemagref	17, avenue de Cucillé,	35044	Rennes Cedex	France
DERIKX Piet	Dr	Instituut voor Mechanisatie. Arbeid en Gebouwen (IMAG-DLO)	Mansholtlaan 10-12, PO. Box 43.	6700 AA	Wageningen	Holland
DOLLE Jean-Baptiste	Mr	Institut de l'Elevage	57, avenue Roger Salengro, BP 32,	62051	St Laurent Blanzay	France
ELLOUET Catherine	Prof	Université de Bretagne Occidentale UMR 6521	6, avenue Victor le Gorgeu,	29285	Brest Cedex	France
ELMQUIST Helena	PhD	Swedish Institute of Agricultural Science	Division of Soil Management, PO Box 7014,	S-750 07	Uppsala	Sweden
FABBRI Claudio	Dr	Centro Ricerce Produzioni Animali (CRPA)	Via Crispi 3, Corso Garibaldi 42,	42100	Reggio Emilia	Italy
FARDEAU Jean-Claude	Dr	CEA/INRA	Science du Sol, Route de St Cyr,	78000	Versailles	France
FAUVEL Yannick	Mr	I.N.R.A.	65, rue de St Brieu,	35042	Rennes Cedex	France
FLURA Dominique	Mr	I.N.R.A.	Station de Bioclimatologie,	78850	Thiverval Grignon	France
FRANKINET Marc	Mr	Centre de Recherche Agronomique	Département Production Végétale, Chemin de Liroux 11,	5030	Gembloux	Belgium

GENERMONT Sophie	Mme	I.N.R.A.	Station de Bioclimatologie,	78850	Thiverval Grignon	France
GOSS Michael	Mr	University of Guelph	Department of Land Ressource Science, Guelph,	N1G 2W1	Ontario	Canada
GUINGAND Nadine	Mme	Institut Technique du Porc	BP 3,	35650	Le Rheu	France
GUIZIOU Fabrice	Mr	Cemagref	17, avenue de Cucillé,	35044	Rennes Cedex	France
HACALA Sylvie	Mme	Institu de l'Elevage	14, avenue Jean Joxé, BP 646,	49006	Angers Cedex 01	France
HALL Jeremy	Mr	WRc plc	Henley Road, Medmenham, Marlow,	SL7 2HD	Buckinghamsh ire	United Kingdom
HEINONEN- TANSKI Helvi	Dr	University of KUOPIU	Department of Environmental Sciences, POB 1627,	FIN 70211	Kuopiu	Finland
HERTER Ulrich	Dr	Swiss Federal Research Station for Agroecology and Agriculture	Reckenholzstr. 191,	CH-8046	Zurich- Reckenholz	Switzerland
HOBBS Philip	Dr	IGER	North Wyke, Okehampton,	EX20 2SB	Devon	United Kingdom
HOERNIG Günter	Prof. Dr	Institute of Agricultural Engineering Bornim	Max-Eyth Allee 100,	D-14468	Potsdam- Bornim	Germany
HOGLUND Caroline	Mrs	Swedish Institute for Infectious Disease Control	Department of Water and Environmental Microbiology,	10521	Stockholm	Sweden
HOUOT Sabine	Dr	I.N.R.A. Science du Sol	Centre de Grignon, BP 01,	78850	Thiverval Grignon	France
HRAZDIRA Jaroslav	Dr	Lhoist Ltd. Praha	Bavorska 856,		Praha	Czech Republic
HUIJSMANS Jan	Ir	Institute of Agricultural and Environmental Engineering	(IMAG-DLO), PO Box 43,	6700 AA	Wageningen	The Netherlands
HUNT Patrick	Dr	USDA-ARS/NCSU	Coastal Plains Soil, Water and Plant Research Center, 2611 W. Lucas St.,	29501-1242	Florence, SC	USA
HURVOIS Yvan	Mr	Agence de l'Eau Loire Bretagne	1, rue Eugène Varlin, BP 40521,	44105	Nantes Cedex 04	France
JAFFREZIC Anne	Dr	I.N.R.A.	Sciences du Sol, 65, rue de St Briec,	35042	Rennes Cedex	France
JULIAN Marie-Pierre	Mme	SOLAGRO	219, avenue de Muret,	31300	Toulouse	France
JURIS Peter	PhD	Parasitological Institute SAS	Hinkova 3,	04001	Kosice	Slovakia
KERMARREC Christophe	Mr	I.N.R.A.	Laboratoire de Bioclimatologie, 65, rue de St Briec,	35042	Rennes Cedex	France
KLIR Jan	Dr	Research Institute of Crop Production	Dmowska Street 507,	CZ 161-06	Praha 6 - Ruzyně	Czech Republic
KOUTEV Vesselin	PhD	N. Poushkarov Institute of Soil Science and Agroecology	Agrochemistry' Departm ent, 7 Chaussee Bankya,	1080	Sofia	Bulgaria
KRELL Rainer	Mr	FAO	Regional Office for Europe (REUR), Via delle Terme di Caracalla,	00100	Rome	Italie

KUSA Helena	Dr	Research Institute of Crop Production	Drnovska 507,	161 06	Praha 6 - Ruzyně	Czech Republic
LE BOZEC Gildas	Mr	Cemagref	17, avenue de Cucillé,	35044	Rennes Cedex	France
LE GALL André	Mr	INSTITUT DE L'ELEVAGE	Monvoisin,	35650	Le Rheu	France
LECLERCQ O.	Mr	SITA.	Technopôle CNPP. BP 2265, Route de la Chapelle Réanville,	27950	Saint Marcel	France
LENEHAN J.J.	Mr	Teagasc	Grange Research Centre Oak Park, Dunsany,		Co. Meath	Ireland
LINERES Monique	Dr	I.N.R.A.	71, avenue Edouard Bourleaux, BP 81,	33140	Villeneuve D'ornon	France
LORENZ Frank	Dr	Landwirtschaftliche Untersuchungs und Forschungsanstalt (LUFA)	der Landwirtschaftskammer Weser-Ems, Jaegerstr.23-27,	26121	Oldenburg	Germany
LUPTON Sylvie	Mme	CIRED. Laboratoire d'Econométrie	Ecole Polytechnique, 1, rue Descartes,	75005	Paris	France
MACHET Jean-Marie	Ing	I.N.R.A.	Rue Fernand Christ,	02000	Laon	France
MADEC	Mr	CNEVA	Zoopôle les Croix,	22440	Ploufragan	France
MAGETTE William	Dr	Agricultural and Food Engineering Department	University College Dublin, Earlsfort Terrace,		Dublin 2	Ireland
MALGERYD Johan	Mr	Swedish Institute of Agricultural Engineering	PO Box 7033,	SE 75007	Uppsala	Sweden
MALKKI Sirikka	Dr	TTS - INSTITUTE	Work Efficiency Institute, P.O. Box 13,	FIN-05201	Rajamaki	Finland
MANFREDI Daniel	Dr	Services Vétérinaires	7, rue Turgot,	29334	Quimper Cedex	France
MARCOVECCHIO Fabrice	Mr	Station Agronomique de l'Aisne	Rue Fernand Christ,	02000	Laon	France
MARQUET Jérôme	Mr	AGRALCO	Service Environnement,	53220	Pontmain	France
MARREC Jacques	Mr	ENSA. INRA	Laboratoire de Science du Sol, 65, route de St Brieuc,	35042	Rennes Cedex	France
MARTEL Jean-Luc	Mr	SITA.	Technopôle CNPP. BP 2265, Route de la Chapelle Réanville,	27950	Saint Marcel	France
MARTENS Wolfram	Dr	Institute for Environmental and Animal Hygiene	University of Hohenheim,	D-70593	Stuttgart	Germany
MARTH Peter	Mr	Plant Helath and Soil Conservation Station of Budapest	Budaörsi ut 141-145,	1118	Budapest	Hungary
MARTINEZ José	Dr	Cemagref	17, avenue de Cucillé,	35044	Rennes Cedex	France
MASSE D.	Dr	Agriculture Canada	Dairy and Swine Research and Development Centre Agriculture, P.O. Box 90 2000 Route 108 EAST,	J1M 1Z3	Lennoxville (Quebec)	Canada
MASSICOTTE	Mr	Centre de Recherche Industrielle du Québec	333, rue Franquet,		Sainte-Foy (Quebec)	Canada

MATSUDA Juzo	Prof	Department of Agricultural Engineering	Hokkaido University, KITA 9. NISHI 9. KITA-KV,	060-8589	Sapporo	Japan
MENZI Harald	Dr	Institute of Environmental Protection and Agriculture (IUL)	Liebefeld,	CH-3003	Berne	Switzerland
MERILLOT Jean-Marc	Mr	ADEME	2, square La Fayette, BP 406,	49004	Angers	France
MESZAROS György	Dr	Hungarian Institute of Agricultural Engineering. HIAE	Quality Testing Society p.u, Tessedik Su 4,	H-2100	Godollo	Hungary
MISSSELBROOK Thomas	Mr	(IGER)	North Wyke, Okehampton,	EX20 2SB	Devon	United Kingdom
MORAND Philippe	Mr	CNRS Université Rennes 1	U.M.R. 6553, Station Biologique,	35380	Paimpont	France
MORKS P.	Mr	SITA.	Technopôle CNPP. BP 2265, Route de la Chapelle Réanville,	27950	Saint Marcel	France
MORVAN Thierry	Mr	INRA	65, rue de St Brieuc,	35042	Rennes Cedex	France
NICHOLSON Fiona	Dr	ADAS Gleadthorpe Research Centre	Meden Vale, Mansfield,	NG20 9PF	Nottinghamshire	United Kingdom
NICHOLSON Robert	Mr	ADAS	Boxworth, Battlegate Road,	CB3 7SB	Cambridge	United Kingdom
NICOLARDOT Bernard	Dr	INRA Unité d'Agronomie de Chalons-Reims	2, Esplanade Roland Garros, BP 224,	51686	Reims Cedex 2	France
OLASZ Zsuzsa	Mrs	Plant Helath and Soil Conservation Station of Budapest	Budaörsi ut 141-145,	1118	Budapest	Hungary
OLIVEIRA Paulo Armando	Mr	I.N.R.A.	Laboratoire de Bioclimatologie, 65, rue de St Brieuc,	35042	Rennes Cedex	France
PAIN Brian	Dr	IGER	North Wyke, Okehampton,	EX20 2SB	Devon	United Kingdom
PARNAUDEAU Virginie	Mme	INRA	2, Esplanade R. Garros,	51686	Reims Cedex 2	France
PATNI Naveen	Dr	Pacific Agri-Food Research Centre	Box 1000, 69407 H7 Highway,	AGASSIZ	British Columbia	Canada
PAULSRUD Bjørne	Mr	AQUATEAM	Norwegian Water Technology Centre as, PO Box 6875 Rodeloekka,	D504	Oslo	Norway
PEU Pascal	Mr	Cemagref	17, avenue de Cucillé,	35044	Rennes Cedex	France
POCHAT Rémi	Mr	Cemagref	Département Equipements pour l'Eau et l'Environnement, BP 44,	92163	Antony Cedex	France
PROVOLO Giogio	Dr	Istituto di Ingegneria Agraria	Via Celoria 2,	I-20 133	Milano	Italy
QUINTEL François	Prof	Université de Bretagne Occidentale UMR 6521	6, avenue Victor le Gorgeu,	29285	Brest Cedex	France
REITZ Petra	Ing	University of Hohenheim	Institute of Agricultural Engineering (440LT) Garbenstr.9,	D-70599	Stuttgart	Germany
REYNE Sandrine	Mme	SCE Environmental Consultants	Atlanpôle, BP 10703,	44307	Nantes Cedex 3	France

ROBERT Michel	Dr	Ministère de l'Aménagement du Territoire et de l'Environnement	20, avenue de Ségur,	75007	Paris	France
ROBIN Paul	Dr	INRA	Laboratoire de Science du Sol, 65, route de St Briec,	35042	Rennes Cedex	France
ROGEAU Didier	Mr	Cemagref	17, avenue de Cucillé,	35044	Rennes Cedex	France
SALAZAR Francisco	Mr	IGER	North Wyke, Okehampton,	EX20 2SB	Devon	United Kingdom
SANGIORGI Franco	Prof	Instituto di Ingegneria Agraria	Via Celoria 2,	I-20 133	Milano	Italy
SATTER Inge	Mse	IMAG - DLO	Mansholtlaan 10-12,		Wageningen	The Netherlands
SENEZ Laurent	Mr	I.N.R.A.	17, rue de Sully, BV 1540,	21034	Dijon	France
SIEGENTHALER Albrecht	Mr	Institute of Environmental Protection and Agriculture	Liebefeld, Schwarzenburgstr.155,	CH-3003	Berne	Switzerland
SKJELHAUGEN Odd Jarle	Dr	The Agricultural University of Norway	Department of Agricultural Engineering, PO Box 5065,	N-1432	As Nih	Norway
SMYTH Sara	Ms	Agricultural Food Engineering	University College Dublin, Earlsfort Terrace,		Dublin 2	Ireland
SOMMER Sven Gjedde	Dr	Dept. of Agricultural Engineering	Research Centre Foulum, PO Box 536,	DK- 8700	Horsens	Denmark
STEFFENS Guenter	Dr	Landw Untersuchungs und Forschungsanstalt (LUFA)	Jagerstrasse 23-27,	26121	Oldenburg	Germany
THIRION François	Mr	Cemagref	Site de Montoldre, Domaine des Palaquins,	03150	Varenes Sur Allier	France
TOFFOLET R.	Mr	SITA	Technopôle CNPP. BP 2265, Route de la Chapelle Réanville,	27950	Saint Marcel	France
TROCHARD Robert	Mr	ITCF	Station Expérimentale de la Jaillière,	44370	Varades	France
TROLARD Fabienne	Dr	INRA	Sciences du Sol et Bioclimatologie, 65, rue de St Briec,	35042	Rennes Cedex	France
UNWIN Roger	Mr	FRCA MAFF	Nobel House, 17, Smith Square,	SW1 3JR	London	United Kingdom
VAN GASTEL Jos	Ing	TMS Technick	Schuurkenspad 7,	5986 PD	Beringe	The Netherlands
VAN WAGENBERG Coen	Dr	Praktiskonderzoek Varkenshouderij	Lunerkampweg 7, Postbus 83,	5240 AB	Rosmalen	The Netherlands
VANOTTI Matias	Dr	USDA-ARS/NCNU	Coastal Plains Soil, Water and Plant Research Center, 2611 W. Lucas St.,	29501-1242	Florence, SC	USA
VENGLOVSKY Jän	Dr	Ministry of Agriculture	Research Institute of Experimental Veterinary Medicine, Hlinkova 1/A,	O4001	Kosice	Slovakia
VINNERAS Bjorn	Dr	Swedish University of Agricultural Sciences	Department of Agricultural Engineering, P.O. Box 7033,	S-750 07	Uppsala	Sweden

VLASSAK Karel	Prof	K.U. LEUVEN	Lab. of Soil Fertility and Soil Biology, Kardinaal Mercierlaan 92,	3001	Heverlee	Belgium
WILLIAMS John	Mr	ADAS Boxworth	Battlegate Road, Boxworth,	CB3 8NN	Cambridge	United Kingdom
WOLTERS H.	Mr	TMS Techniek	Schuurkenspad 7,	5986 PD	Beringe	Holland

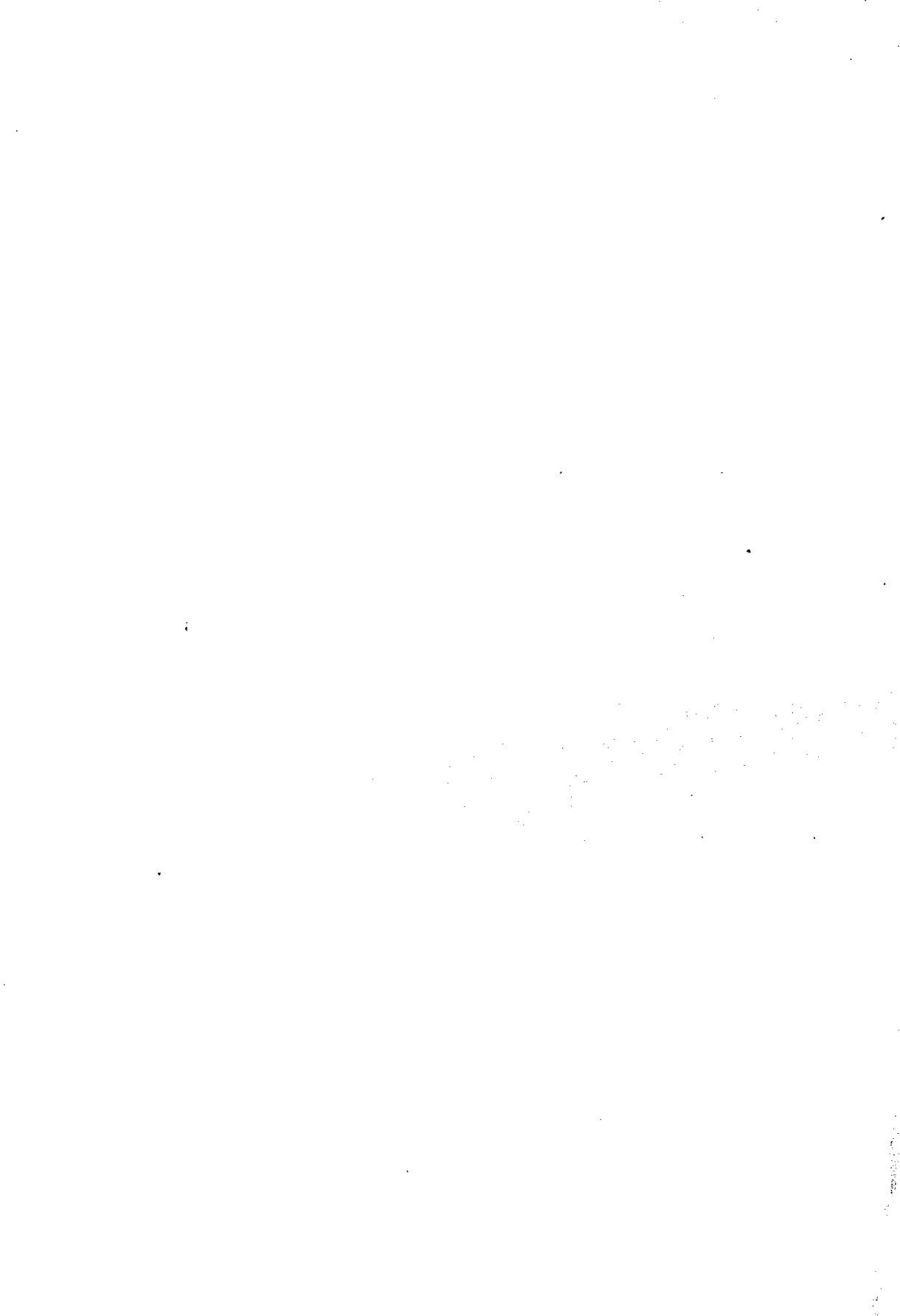







ISBN 2-85362-531-1



9 782853 625319

Cemagref Éditions 1999

Volume 2  
Prix : 250 F TTC  
(38,11 €)